

XCHANGE



FRAME / STRUCTURE / KABINENGESTELL

Frame. 101x101mm extruded aluminium tracks with quick-assembly 3-way elbow joint connectors.

Glazed wall panelling. Single or double acoustic glass panel, it can be height adjusted using patented levellers located in the bottom tracks.

Solid wall panelling. Double 18mm MFC panels finished with ABS edges. Fire tested Class 2. Acoustic fully upholstered internal panel available as an optional extra.

Solid wall frame. Made from metal tube and a racking system to clip panels and accessories onto it. PVC gaskets ensure reliable sealing.

Cadre composé par profils en aluminium extrudé 101x101mm avec noeuds structurels à fixation rapide.

Section vitrée avec verre simple ou double réglable avec des régulateurs insérés dans les profils en aluminium extrudé.

Parties pleines réalisées avec panneaux doubles en conglomérat de bois mélaminé ép.18mm avec chants ABS, en classe 2 de réaction au feu. La partie interne peut être composée également par un panneau acoustique revêtu en tissu.

La structure réglable du module plein est réalisée en tube de métal profilé avec triple crémaillère pour la fixation des tamponnement et des accessoires. Les parties externes sont isolées par des joints coextrudés en PVC.

Tragrahmen aus stranggepressten Aluminiumprofilen, Profil 101x101mm, mit baulichen Schnellkupplungsknoten.

Verglaste Strecken aus einfacher oder doppelter Akustikscheibe, die mit Hilfe von Reglern, die in die stranggepressten Aluminiumprofile eingesetzt werden, einstellbar sind.

Geschlossene Strecken mit 2 Platten aus melaminbeschichtetem Holzkonglomerat 18 mm stark mit ABS-Kante, in Brandverhaltensklasse 2. Der Innenteil kann auch mit einem stoffbezogenem Akustikpaneel ausgestattet werden.

Das verstellbare Gestell der geschlossenen Wanstrecke besteht aus profiliertem Metallrohr mit dreifachem Profil zum Einhängen der Füllungsplatten und des Zubehörs. Die Umfangsteile sind durch koextrudierte PVC-Dichtungen isoliert.

Finishes

Finitions

Ausführungen



Anodized
Anodiséé
Eloxiert



Anthracite
Gris ombre
Dunkelgrau

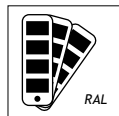

RAL colour of your choice
RAL au choix
RAL nach Wahl

GLAZED WALL PANELS / CLOISON VITRÉE / GLASSTRECKE

12.76mm thick acoustic laminated glass comprising two layers of glass bonded together using a PVB interlayer reducing vibrations.

Verre stratifié avec isolation acoustique ép. 12,76 mm composé par deux vitres liés entre eux par un film en PVB, qui agit comme un amortisseur entre les deux vitres et empêche les vibrations en réduisant le problème de la fréquence critique et par conséquent les chutes aux hautes fréquences.

12,76 mm starkes schallisoliertes Verbundglas, das aus zwei Glasscheiben besteht, die durch eine PVB-Folie miteinander verbunden sind, die als Stoßdämpfer zwischen den beiden Glasscheiben wirkt und Vibrationen und Schallausbreitung verhindert.

Finishes

Finitions

Ausführungen



Clear
Transparent
Transparent



Frosted
Dépoli
Satiniert

SOLID MFC WALL PANELS / PANNEAUX PLEINS EN MÉLAMINÉ / MELAMINPLATTEN

18mm melamine faced chipboard (MFC) finished with 1.5mm matching straight ABS impact resistant edges, easy to clean scratch-resistant anti-reflective melamine. Panel density: 670/730 kgs per cubic meter. Grain on MFC panels always runs vertically, floor to ceiling.

Réalisé en conglomérat de bois ép. 18 mm, revêtu par papier décoratif imprégné de résine de mélamine résistante aux rayures et lavable avec des chants ABS antichoc ép. 1,5 mm de la même couleur. Densité du panneau: 670/730 kg/m³.

Hergestellt aus 18 mm starkem Holzkonglomerat, überzogen mit Dekorpapier, das mit kratzfestem und abwaschbarem Melaminharz imprägniert ist, mit 1,5 mm starken stoßfesten ABS-Randkanten in passender Farbe. Plattendichte: 670/730 kg/m³.

Finishes

Finitions

Ausführungen

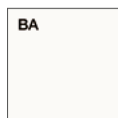

White
Blanc
Weiss



Silver
Aluminium
Silber



Grey
Gris
Grau



Concrete
Béton
Beton

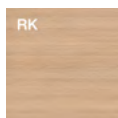

Oak
Chêne
Eiche hell

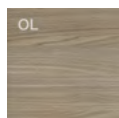

Elm
Orme
Ulme



Canaletto Walnut
Noyer Canaletto
Nuss Canaletto



Anthracite linen
Tissu gris
Leinen grau

Specification sheet Caracteristiques techniques Technische erkmalen

SOLID VENEERED WALL PANELS / PANNEAUX PLEINS EN BLOIS PLACAGE / FURNIERTE HOLZPANEELE

18mm veneered MDF, matt transparent semi-open pore varnished 0.6mm wood veneer, 1mm wood veneer edging, 0.5mm radiused corners. Panel density 720/790 kgs per cubic meter. Grain on veneered panels always runs vertically, floor to ceiling.

Réalisé en conglomérat de bois (MDF) de 18 mm d'épaisseur, placage de bois de 0,6 mm d'épaisseur, chants en bois de 1 mm d'épaisseur, chants arrondis de 0,5 mm et vernis transparent mat à pores semi-ouverts. Densité du panneau: 720/790 kg/m³.

Hergestellt aus 18 mm starkem Holzkonglomerat (MDF), 0,6 mm starkem Holzurnier, mit 1 mm starken Holzkanten, 0,5 mm abgerundeten Kanten und halboffenem, transparentem Mattlack. Plattendichte: 720/790 kg / m³.

Finishes

Finitions
Ausführungen



OG Elm Orme gris Ulme grau	NA American walnut Noyer américain Nußbaum	EB Ebony Ébène Ebenholz
--	--	---

SOLID LACQUERED MFC WALL PANELS / PANNEAUX PLEINS EN MÉLAMINÉ LAQUÉ / LACKIERTE MELAMINPLATTEN

18mm matt lacquered melamine faced chipboard (MFC) finished with 1.5mm matching straight ABS impact resistant edges.
Panel density: 670/730 kgs per cubic meter.

Réalisé en conglomérat de bois ép. 18 mm, avec chants ABS antichoc ép. 1,5 mm, vernis en laqué mat. Densité du panneau: 670/730 kg/m³.

Hergestellt aus 18 mm starkem Holzkonglomerat, mit 1,5 mm starken stoßfesten ABS-Umfangkanten, matt lackiert. Plattendichte: 670/730 kg/m³.

Finishes

Finitions
Ausführungen



ACOUSTIC FULLY UPHOLSTERED WALL PANELS / PANNEAUX PLEINS EN TISSU ACOUSTIQUE / AKUSTISCHE STOFFPANEELE

Available for interiors only. 3mm MDF panel fully upholstered in a Trevira CS fabric in several colour options, paired with a layer of acoustic foam.
Perimeter frame made from aluminium profiles.

Disponible uniquement pour le côté interne. Composé par un panneau MDF ép. 3 mm avec un matelas en mousse insonorisant, revêtu par tissu Trevira CS en différentes couleurs. Structure périphérique composée par profils en aluminium.

Nur für die innere Seite der Kabine verfügbar. Bestehend aus einer 3 mm starken mdf-Platte in Verbindung mit einer schallabsorbierenden Schaumstoffmatratze, die mit Trevira CS-Stoff in verschiedenen Farben bezogen ist. Rahmngestell aus Aluminiumprofilen.

Finishes

Finitions
Ausführungen



3X2M ACOUSTIC BOOTH / CABINE ACOUSTIQUE 3X2 / AKUSTIK-KABINE 3X2

Tracks available in:

- anodized aluminium (standard)
- powder coated in anthracite
- powder coated in a RAL colour of your choice

Profils disponibles en:

- aluminium anodisé (standard)
- vernis gris ombre
- vernis RAL au choix

Profile verfügbar in:

- eloxiertes Aluminium (Standard)
- dunkelgrau lackiert
- RAL-Lackierung nach Wahl

8mm melamine faced chipboard (MFC) ceiling panel

Panneau supérieur de fermeture en mélaminé ép. 8mm
Oberes Abschlusspaneel aus Melamin 8 mm stark

LED ceiling lighting

Barre LED intégrée
Eingebaute LED-Leiste

Internal ceiling available in:

- melamine
 - acoustic upholstery
- Plafond intérieur disponible en:
- mélaminé
- tissu acoustique
- Innere Decke verfügbar in:
- Melamin
- akustischer Stoff

External solid panels available in:

- melamine
- lacquered melamine
- wood veneer

Panneaux extérieurs disponibles en:

- mélaminé
- mélaminé laqué
- placage bois

Außere Paneele verfügbar in:

- Melamin
- lackiertes Melamin
- Furniertes Holz

Switch post for acoustic upholstered walls

Module technique pour cloison en tissu acoustique
Technisches Modul für Stoffwandstrecke

Internal solid panels available in:

- melamine
- lacquered melamine
- wood veneer
- acoustic upholstery

Panneaux internes disponibles en:

- mélaminé
- mélaminé laqué
- placage bois
- tissu acoustique

Innere Paneele verfügbar in:

- Melamin
- lackiertes Melamin
- Furniertes Holz
- akustischer Stoff

PLEASE NOTE: at least one solid wall panel is mandatory

ATTENTION: Un côté plein toujours obligatoire

WARNUNG: Eine geschlossene Wandstrecke ist immer erforderlich

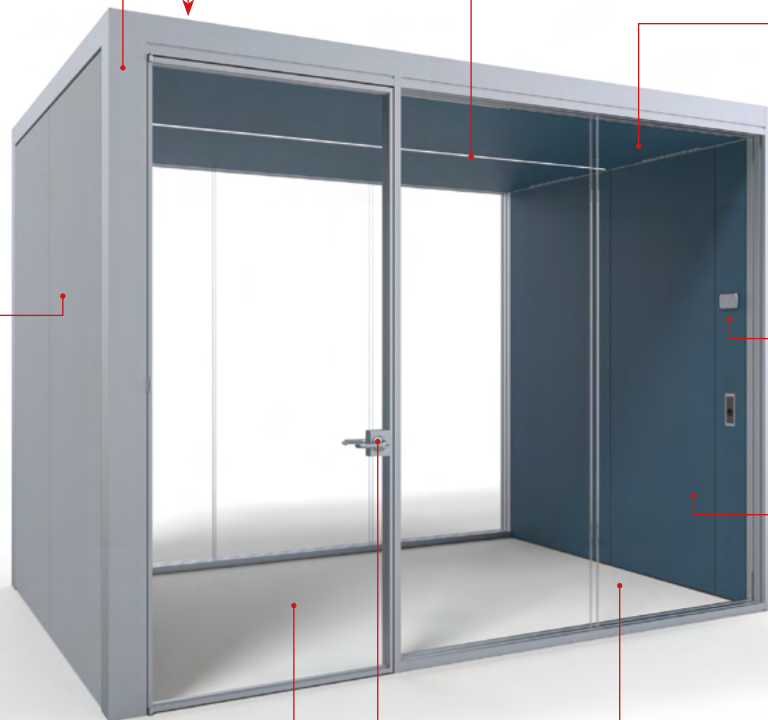

Single or double glazed hinged framed door

Porte vitrée avec cadre, simple ou double vitrage

Einzel- oder Doppelscheiben-Glasrahmentür

HCS or AGB handle complete with lock

Poignée HCS ou AGB avec serrure

HCS- oder AGB-Griff mit Schloss

Single or double acoustic glass panels

Verre acoustique simple ou double

Einfach- oder Doppelscheiben-Akustikglas

HANDLES / POIGNÉES / GRIFFE

HCS

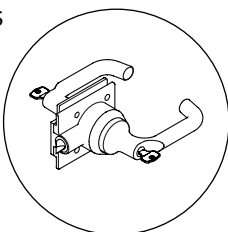

Paris

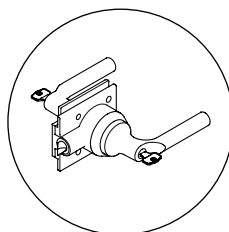

Bonn

AGB

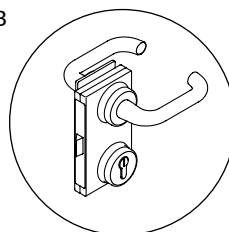

Paris

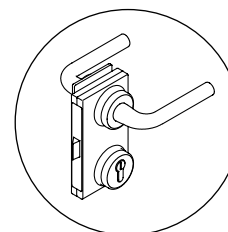

Bonn

IMPORTANT INFORMATION / INFORMATIONS IMPORTANTES / WICHTIGE INFORMATIONEN



- All 1x1m booths must have at least one solid wall panel.
- In 1x1m booths ventilation control is always located on the ceiling.
- Acoustic upholstery available for internal panels only.
- The optional power module is available for solid wall panels only, should the internal panels be upholstered a switch post is then also required.
- Toutes les compositions 1x1 doivent avoir au moins 1 côté plein.
- Le système de aération peut être calibré en agissant sur le régulateur approprié positionné au plafond.
- Le module en tissu acoustique est disponible uniquement pour les côtés internes.
- La multiprise électrique (en option) est disponible uniquement pour la section panneau ou la section tissu avec module technique.
- Alle 1x1-Kompositionen müssen mindestens 1 geschlossene Wandstrecke haben.
- Das Lüftungssystem kann durch Einwirken auf den speziellen Schalter an der Decke kalibriert werden.
- Das schallabsorbierende Stoffmodul ist nur für die Innenseiten erhältlich.
- Die elektrische Mehrfachsteckdose (optional) ist nur für Paneel- oder Stoffsektionen mit technischem Modul erhältlich.



- All 2x1m, 2x2m, 3x2m, 3x3m, 3x4m booths must have at least one solid wall panel.
- In all booths other than 1x1m, ventilation control is achieved using a display located on a solid wall panel; should the booth have just one solid wall panel and that panel be upholstered, an upholstered switch post is then also required.
- Acoustic upholstery available for internal panels only.
- The optional power module is available for solid wall panels only, should the internal panels be upholstered a switch post is then also required.
- Toutes les compositions 2x1, 2x2, 3x2, 3x3, 3x4 doivent avoir au moins 1 côté plein.
- Le système de ventilation est géré par un display positionné sur le côté plein à l'intérieur de la cabine; dans le cas où le seul côté plein est en tissu acoustique, l'inclusion du module technique permettant son application est obligatoire.
- Le module en tissu acoustique est disponible uniquement pour les côtés internes.
- La multiprise électrique (en option) est disponible uniquement pour la section panneau ou la section tissu avec module technique
- Alle 2x1, 2x2, 3x2, 3x3, 3x4 Kompositionen müssen mindestens 1 geschlossene Wandstrecke haben.
- Das Lüftungssystem wird über ein Display gesteuert, das auf der geschlossenen Wandstrecke im Inneren der Kabine angebracht ist; falls die einzige geschlossenen Wandstrecke aus schalldichtem Stoff besteht, muss ein technische Modul eingesetzt werden, um seine Anwendung zu ermöglichen.
- Das schallabsorbierende Stoffmodul ist nur für die Innenseiten erhältlich.
- Die elektrische Mehrfachsteckdose (optional) ist nur für Paneel- oder Stoffsektionen mit technischem Modul erhältlich.

**EXAMPLE OF GLAZED AND SOLID 3X2M BOOTH / EXEMPLE DE COMPOSITION PLEINE ET VITRÉE 3X2 /
BEISPIEL EINER GESCHLOSSENEN UND VERGLASTEN KOMPOSITION 3X2**

- ① **Solid wall panels**
Section pleine panneau vertical
Geschlossene Wandstrecke mit vertikalen Paneele
- ② **Glazed wall panels**
Section vitrée
Glasstrecke
- ③ **Glazed wall panels with LH door**
Section vitrée porte gauche
Glasstrecke mit linker Tür
- ④ **Ceiling with ventilation**
Plafond avec aération
Decke mit Belüftung
- ⑤ **Aluminium structural frame**
Structure portante en aluminium
Aluminium-Traggestell

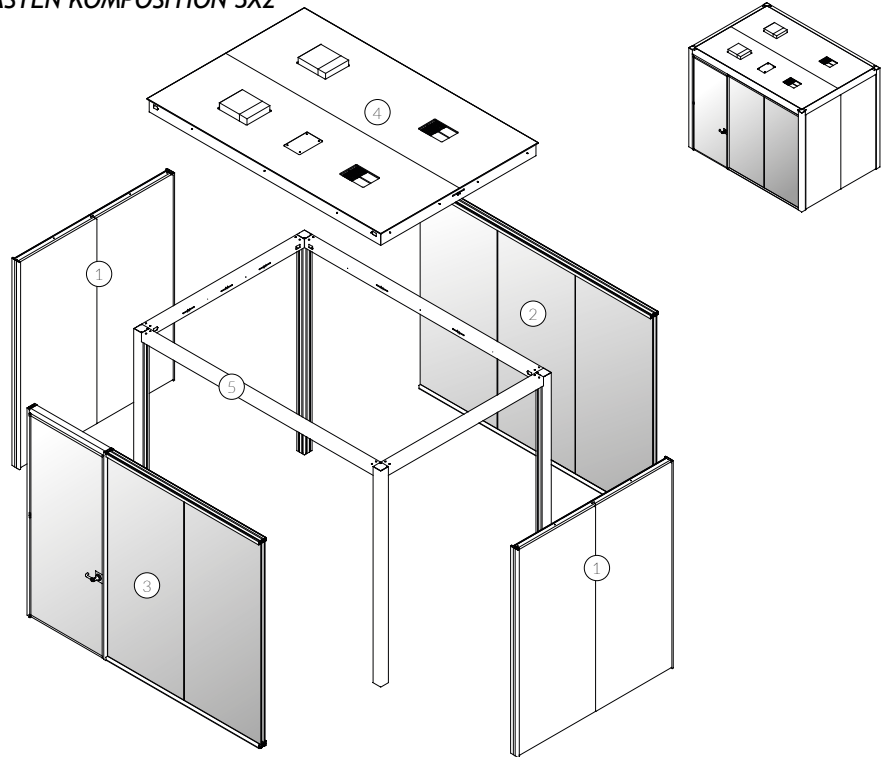

**EXAMPLE OF SOLID 3X2M BOOTH OPEN ON ONE SIDE / EXEMPLE DE COMPOSITION PLEINE 3X4 AVEC CÔTÉ OUVERT /
BEISPIEL EINER GESCHLOSSENEN KOMPOSITION 3X2 MIT OFFENEM TEIL**

- ① **Solid wall panels**
Section pleine panneau vertical
Geschlossene Wandstrecke mit vertikalen Paneele
- ② **Open side**
Section ouverte
Offene Strecke
- ③ **Ceiling without ventilation**
Plafond avec aération
Decke ohne Belüftung
- ④ **Aluminium structural frame**
Structure portante en aluminium
Aluminium-Traggestell

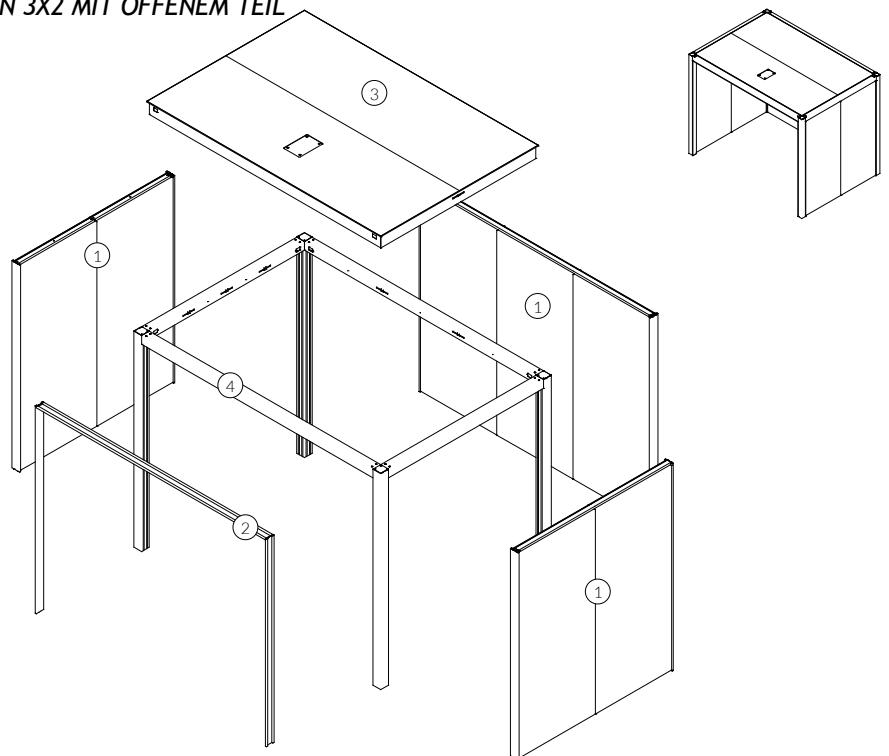

CEILING WITHOUT VENTILATION / PLAFOND SANS AÉRATION / DECKE OHNE BELÜFTUNG

- ① **IP65 switchboard**
 Tableau électrique IP65
Schalttafel IP65
- ② **Structural beam with LED strip**
 Traverse structurelle avec barre LED
Tragende Traverse mit LED-Leiste
- ③ **8mm melamine faced chipboard (MFC) external panel**
 Panneau de fermeture en mélaminé ép. 8mm
Abschlußpaneelle aus Melamin 8mm stark
- ④ **Sound absorbing material**
 Matelas insonorisant
Schalldämmende Matte
- ⑤ **Internal ceiling panel in melamine or full acoustic upholstery**
 Panneau inférieur en mélaminé ou tissu acoustique
Unteres Paneel aus Melamin oder schallabsorbierendem Stoff

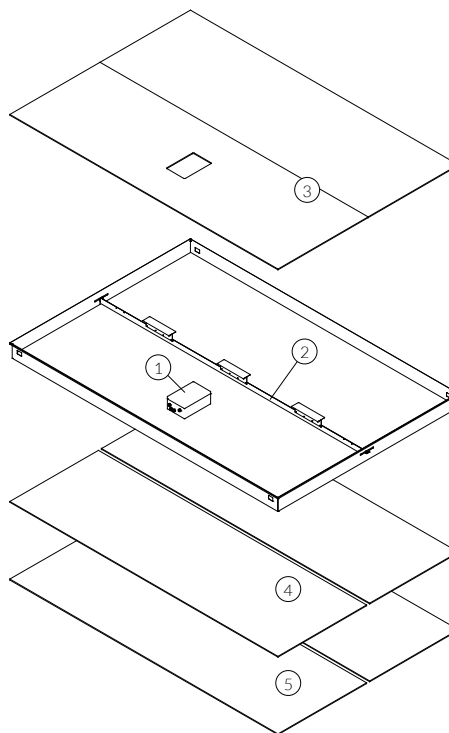

PLEASE NOTE: For closed booths we recommend to add ventilation
 NB: le plafond sans aération n'est pas recommandé pour les cabines fermées.
 BITTE BEACHTEN SIE: Die Decke ohne Belüftung wird für geschlossene Kabinen nicht empfohlen.

CEILING WITH VENTILATION / PLAFOND AVEC AÉRATION/ DECKE MIT BELÜFTUNG

- ① **IP65 switchboard**
 Tableau électrique IP65
Schalttafel IP65
- ② **Structural beam with LED strip**
 Traverse structurelle avec barre LED
Tragende Traverse mit LED-Leiste
- ③ **8mm melamine faced chipboard (MFC) external panel**
 Panneaux de fermeture en mélaminé ép. 8mm
Abschlußpaneelle aus Melamin 8mm stark
- ④ **Sound absorbing material**
 Matelas insonorisant
Schalldämmende Matte
- ⑤ **Internal ceiling panel in melamine or full acoustic upholstery**
 Panneau inférieur en mélaminé ou tissu acoustique
Unteres Paneel aus Melamin oder schallabsorbierendem Stoff
- ⑥ **Ventilation unit**
 Groupe ventilateur
Ventilator-Einheit
- ⑦ **Air extraction**
 Plénum de reprise
Entlüftung-Modul
- ⑧ **Air supply**
 Plénum de réfolement
Belüftung-Modul

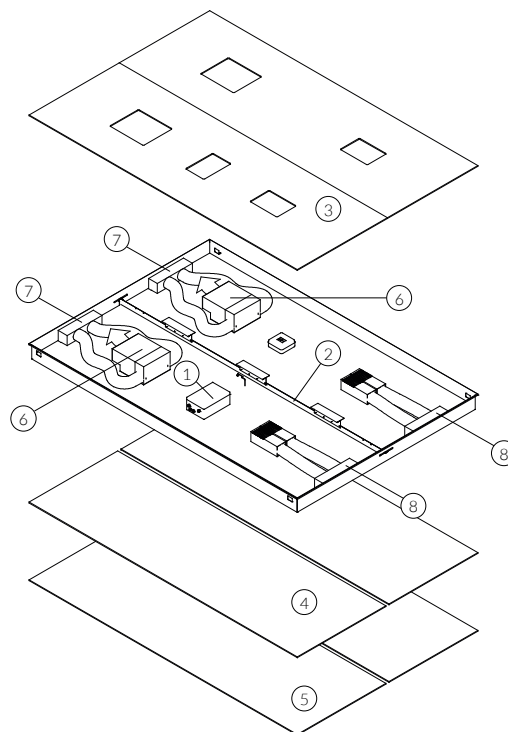

TILED SOLID WALL PANEL / CLOISON PLEINE MODULE HORIZONTAL / GESCHLOSSENE WANDSTRECKE MIT HORIZONTALEM MODUL

- ① **Melamine external panels**
Panneau extérieur en mélaminé
Melamin-Außenplatte
- ② **Internal panels in melamine or full acoustic upholstery**
Panneau interne en mélaminé ou tissu acoustique
Inneres Paneel aus Melamin oder schallabsorbierendem Stoff
- ③ **Sound absorbing material**
Matelas insonorisant
Schalldämmende Matte
- ④ **Vertical stud**
Montant structurel
Struktureller Pfosten
- ⑤ **Aluminium cover**
Profil de départ en aluminium
Aluminium-Abschlußprofil
- ⑥ **Head/floor channel**
Goulotte de fermeture
Verschlußskanal
- ⑦ **Horizontal beam**
Traverse horizontale
Horizontale Traverse

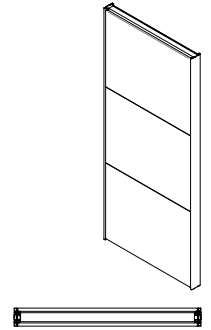
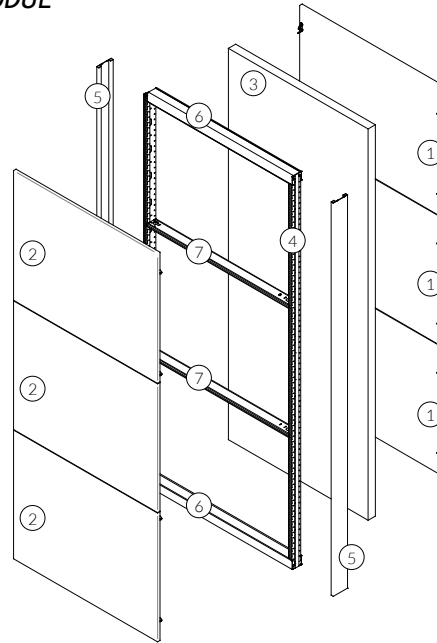

SOLID WALL PANEL / CLOISON PLEINE MODULE VERTICAL / GESCHLOSSENE WANDSTRECKE MIT VERTIKALEM MODUL

- ① **Melamine external panels**
Panneau extérieur en mélaminé
Melamin-Außenplatte
- ② **Internal panels in melamine or full acoustic upholstery**
Panneau interne en mélaminé ou tissu acoustique
Inneres Paneel aus Melamin oder schallabsorbierendem Stoff
- ③ **Sound absorbing material**
Matelas insonorisant
Schalldämmende Matte
- ④ **Vertical stud**
Montant structurel
Struktureller Pfosten
- ⑤ **Aluminium cover**
Profil de départ en aluminium
Aluminium-Abschlußprofil
- ⑥ **Head/floor channel**
Goulotte de fermeture
Verschlußskanal

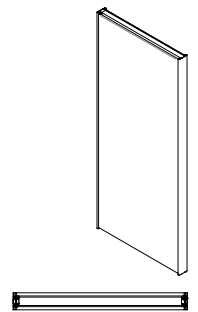
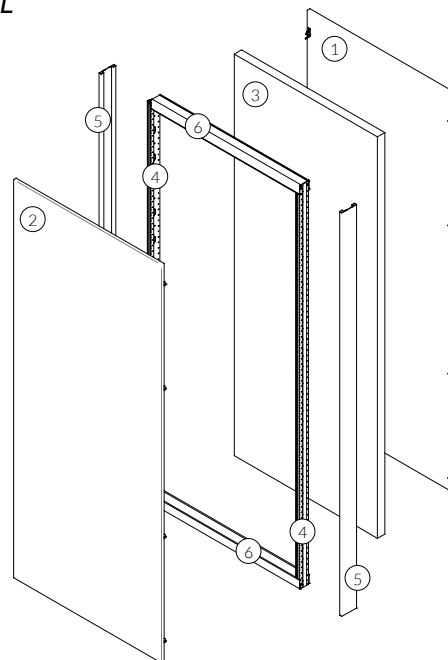

SINGLE GLAZED PANEL / CLOISON VERRE SIMPLE / EINSCHIEBEN-GLASWANDSTRECKE

- ① **6+6.2mm acoustic clear glass panel**
 Verre acoustique 6+6.2
 Akustik-Glasscheibe 6+6,2
- ② **Aluminium track**
 Profil de base en aluminium
 Aluminium-Profil
- ③ **Aluminium track cap**
 Profil de fermeture an aluminium
 Aluminium-Abdeckprofil
- ④ **Height adjustable patented levellers**
 Support verre réglable
 Verstellbare Glashalterung

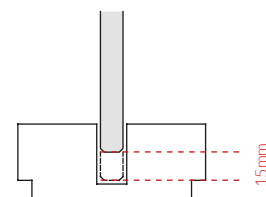
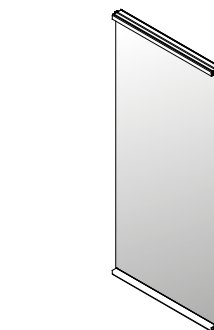
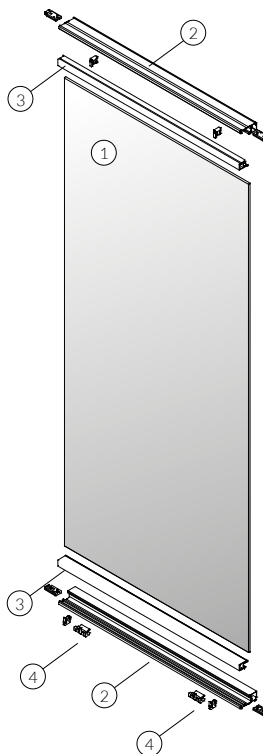

DOUBLE GLAZED PANEL / CLOISON VERRE DOUBLE / WANDSTRECKE MIT DOPPELVERGLASUNG

- ① **6+6.2mm acoustic clear glass panel**
 Verre acoustique 6+6.2
 Akustik-Glasscheibe 6+6,2
- ② **Aluminium track**
 Profil de base en aluminium
 Aluminium-Profil
- ③ **Aluminium track cap**
 Profil de fermeture an aluminium
 Aluminium-Abdeckprofil
- ④ **Height adjustable patented levellers**
 Support verre réglable
 Verstellbare Glashalterung

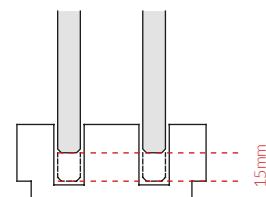
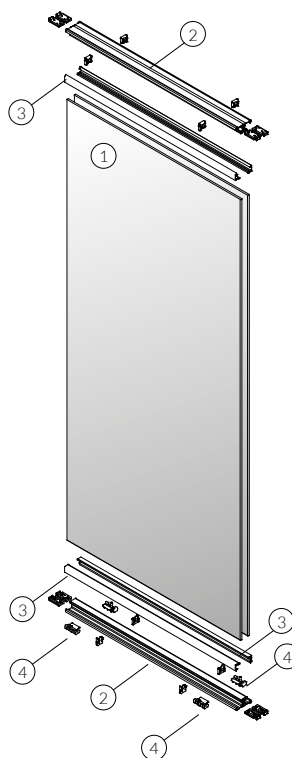

SINGLE GLAZED FRAMED DOOR / PORTE AVEC CADRE VERRE SIMPLE / RAHMENTÜR MIT EINFACHER VERGLASUNG

- ① **Framed single glass panel**
Porte avec cadre verre simple
Rahmentür mit einfacher Verglasung
- ② **Aluminium lock stile (door frame)**
Montant en aluminium côté ouverture
Aluminium-Profil auf der Stosseite
- ③ **Aluminium head transom (door frame)**
Travers en aluminium
Aluminium-Querträger
- ④ **Aluminium hinge stile (door frame)**
Montant en aluminium côté charnière
Aluminium-Profil auf der Bandseite
- ⑤ **Hinges**
Kit charnière
Scharnier-Satz
- ⑥ **Closes automatically gaps between door and floor/ceiling**
Guillotine
Schall-Ex

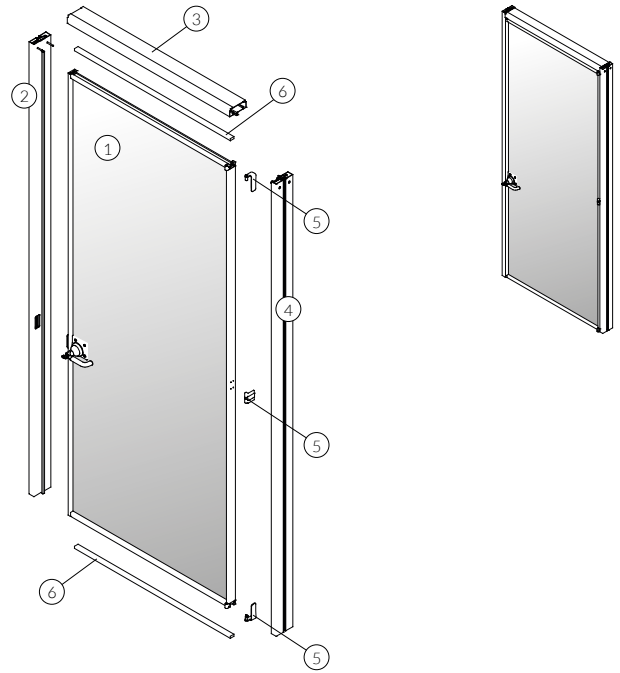

DOUBLE GLAZED FRAMED DOOR / PORTE AVEC CADRE DOUBLE VERRE / DOPPELTE RAHMENTÜR

- ① **Framed double glass panel**
Porte avec cadre double verre
Doppelte Rahmentür
- ② **Aluminium lock stile (door frame)**
Montant en aluminium côté ouverture
Aluminium-Profil auf der Stosseite
- ③ **Aluminium head transom (door frame)**
Travers en aluminium
Aluminium-Querträger
- ④ **Aluminium hinge stile (door frame)**
Montant en aluminium côté charnière
Aluminium-Profil auf der Bandseite
- ⑤ **Hinges**
Kit charnière
Scharnier-Satz
- ⑥ **Closes automatically gaps between door and floor/ceiling**
Guillotine
Schall-Ex

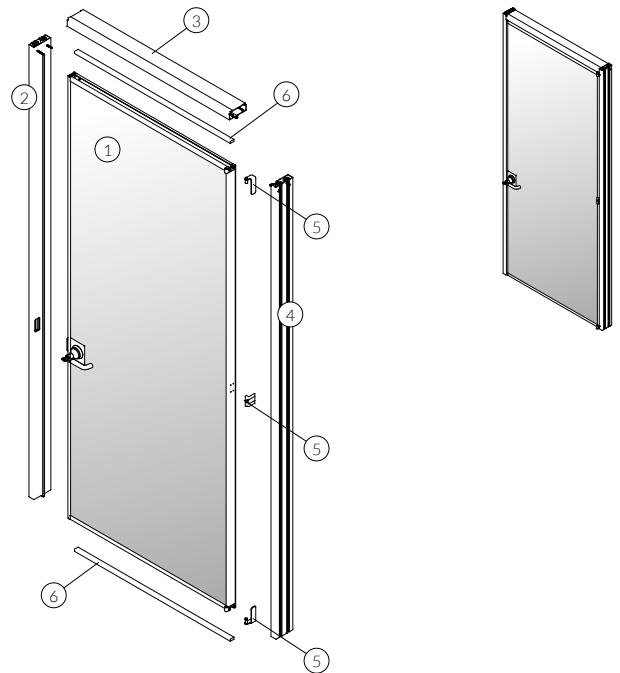

Lighting and wiring Eclairage et câblage Beleuchtung und Verkabelung

LIGHTING/ ECLAIRAGE / BELEUCHTUNG

LED lighting with glare-free prismatic diffuser - 4000K
PIR motion/occupancy sensor as well as dimmer complete with two remote controls are supplied as standard.

Illuminateur LED avec diffuseur microprismatique - Lumière 4000 ° K
Capteur de présence configurable et dimmer pour la régulation de l'intensité lumineuse en standard, complet avec 2 télécommandes pour régler l'intensité lumineuse.

LED-Beleuchtung mit mikroprismatischem Diffusor - Lichttemperatur 4000°K
Konfigurierbarer Anwesenheitssensor und Dimmer inkl. 2 Fernbedienungen zur Einstellung der Lichtintensität.

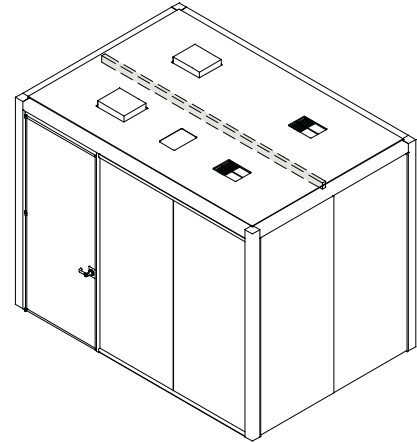
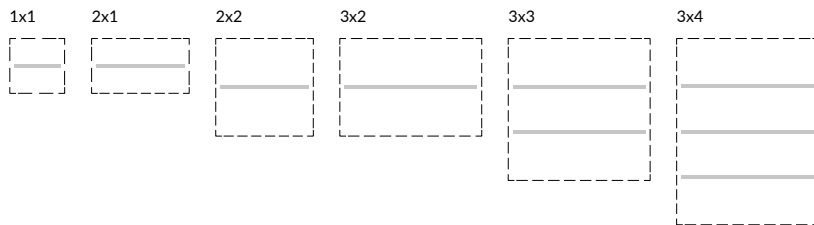

OPTIONS FOR WIRING / SOLUTIONS POUR LE CÂBLAGE/ LÖSUNGEN FÜR DIE VERKABELUNG

- ① **Option 1 - wiring running through aluminium frame from raised floor**
Solution 1 - Câblage sur montant aluminium au sol
Lösung 1 - Verkabelung auf Aluminium-Pfosten am Boden
- ② **Option 2 - wiring running from suspended ceiling**
Solution 2 - Câblage au plafond
Lösung 2 - Deckenverkabelung
- ③ **Option 3 - wiring running through aluminium frame with exit above floor level**
Solution 3 - Câblage latéral extérieur sur montant aluminium
Lösung 3 - Seitliche Verkabelung im Freien auf einem Aluminiumpfosten

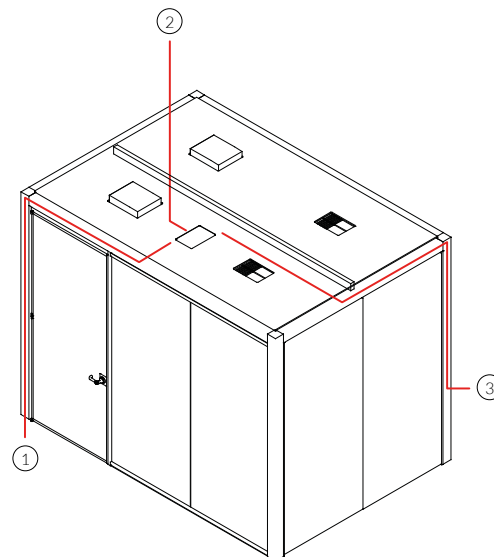

POWER/DATA MODULES / MULTIPRISES ÉLECTRIQUES / ELEKTRISCHE STECKDOSEN

SMALL

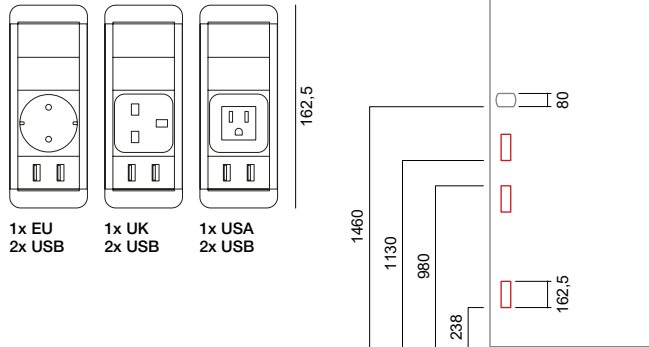

LARGE

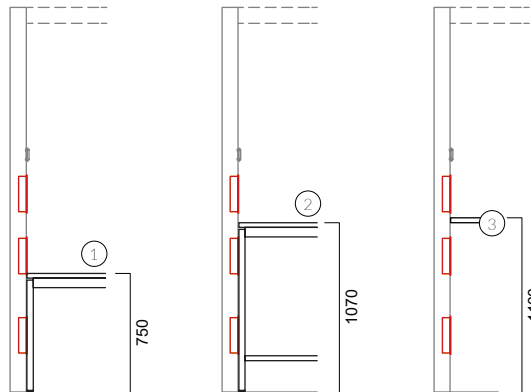
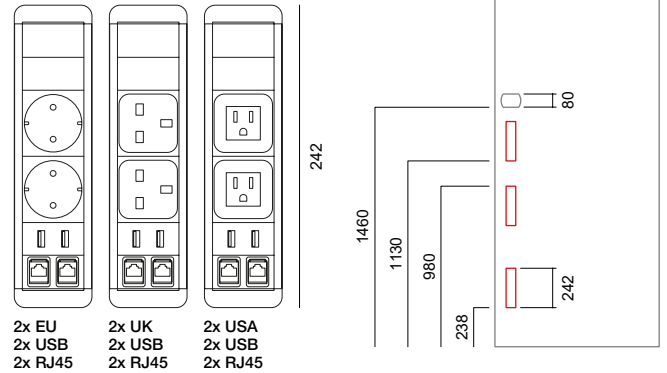

- ① 750mm high desk
Bureau H 750mm
Schreibtisch H 750mm
- ② 1070mm high poseur table
Table haute H 1070mm
Stehtisch H 1070mm
- ③ Shelf 1100mm from floor level
Étagère positionnée à H 1100mm
Wandfachboden auf H 1100mm positioniert

OPTIONAL POSITIONS FOR POWER/DATA MODULES/ SCHÉMA DE POSITIONNEMENT DES MULTIPRISES ÉLECTRIQUES/ POSITIONIERUNGSSCHEMA FÜR MULTI-STECKDOSEN

Factory-made cutout, please specify the desired position in your order.

Trou pour prises électriques réalisé à l'usine, spécifier la position souhaitée lors de l'envoi de la commande.

Bohrung für Steckdose im Werk hergestellt. Geben Sie bitte bei Bestellung die gewünschte Position an.

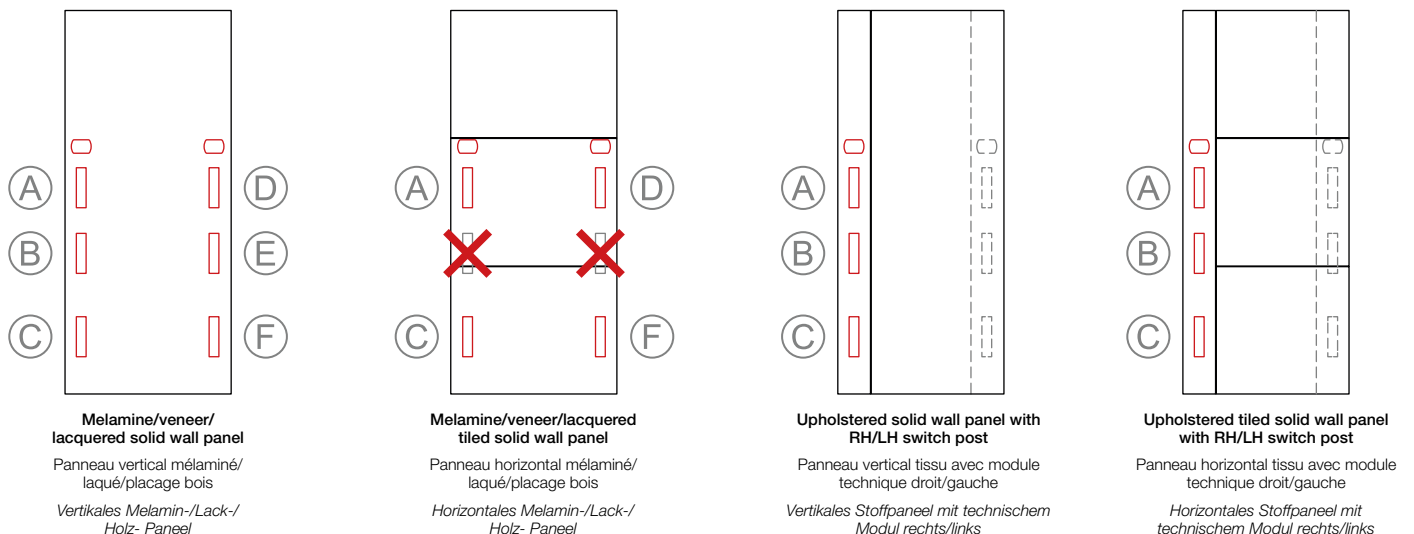

**TILED SOLID WALL PANEL WITH VENTILATION/ CLOISON PLEINE PANNEAU EN MÉLAMINÉ HORIZONTAL /
GESCHLOSSENE WANDSTRECKE MIT HORIZONTAL EN MELAMINPLATTEN**

- | | |
|---|---|
| ① Melamine external panel
Panneau extérieur mélaminé
Außeres Paneel aus Melamin | ⑦ Head/floor channel
Goulotte de fermeture
Verschlusskanal |
| ② Melamine internal panel
Panneau interne mélaminé
Inneres Paneel aus Melamin | ⑧ Factory made cutout for ventilation control
Usinage panneau pour cache boîte
Panelbearbeitung für eingebautes Element |
| ③ Sound absorbing material
Matelas insonorisant
Schalldämmende Matte | ⑨ Flush mounted box
Câche boîte
Eingebautes Element |
| ④ Vertical stud
Montant structurel
Tragender Pfosten | ⑩ Ventilation control
Contrôle ventilation
Steuerungsschalter für Belüftung |
| ⑤ Horizontal beam
Travers horizontal
Horizontale Traverse | ⑪ Power/data module (optional)
Multiprise électrique et données (option)
Elektro- und Datenanschluss (optional) |
| ⑥ Aluminium cover
Profil de départ en aluminium
Abschlussprofil aus Aluminium | |

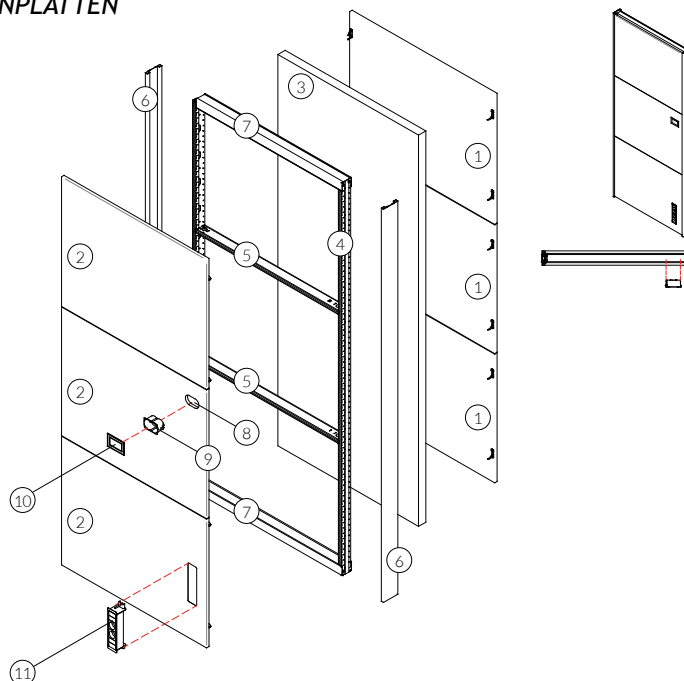

**TILED UPHOLSTERED SOLID WALL PANEL WITH SWITCH POST AND VENTILATION/
CLOISON PLEINE PANNEAU EN TISSU HORIZONTAL AVEC MODULE TECHNIQUE/
GESCHLOSSENE WANDSTRECKE MIT HORIZONTAL EN STOFFPANEELN MIT TECHNISCHEM MODUL**

- | | |
|--|--|
| ① Melamine external panel
Panneau extérieur mélaminé
Außeres Paneel aus Melamin | ⑦ Head/floor channel
Goulotte de fermeture
Verschlusskanal |
| ② Acoustic fully upholstered internal panel
Panneau interne tissu acoustique
Akustisch inneres Paneel stoffbezogen | ⑧ Acoustic fully upholstered switch post
Module technique revêtu en tissu
Technisches Modul mit Stoffbezug |
| ③ Sound absorbing material
Matelas insonorisant
Schalldämmende Matte | ⑨ Vertical stud for switch post
Montant structurel pour module technique
Tragender Pfosten für technisches Modul |
| ④ Vertical stud
Montant structurel
Tragender Pfosten | ⑩ Ventilation control
Contrôle ventilation
Steuerungsschalter für Belüftung |
| ⑤ Horizontal beam
Travers horizontal
Horizontale Traverse | ⑪ Power/data module (optional)
Multiprise électrique et données (option)
Elektro- und Datenanschluss (optional) |
| ⑥ Aluminium cover
Profil de départ en aluminium
Abschlussprofil aus Aluminium | |

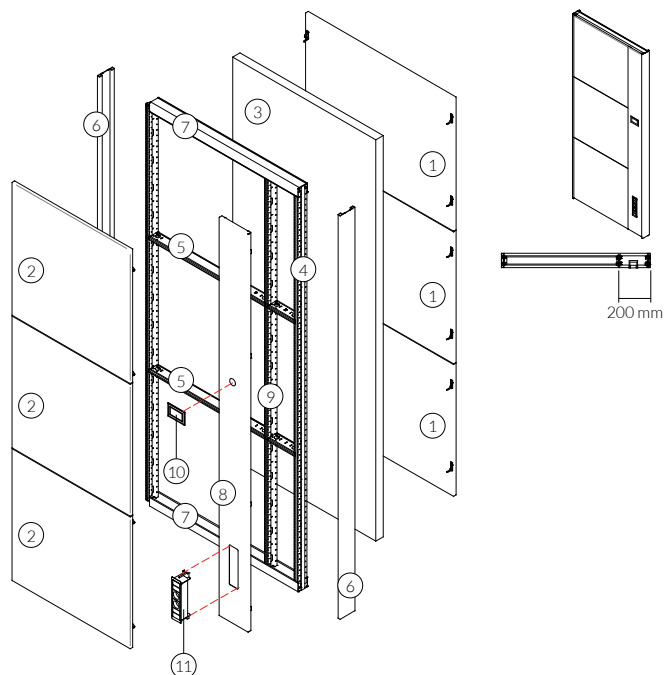

SOLID WALL PANEL WITH VENTILATION / CLOISON PLEINE PANNEAU EN MÉLAMINÉ VERTICEL / GESCHLOSSENE WANDSTRECKE MIT VERTIKALER MELAMINPLATTE

- | | |
|--|--|
| <ul style="list-style-type: none"> ① Melamine external panel
Panneau extérieur mélaminé
<i>Außeres Paneel aus Melamin</i> ② Melamine internal panel
Panneau intérieur mélaminé
<i>Inneres Paneel aus Melamin</i> ③ Sound absorbing material
Matelas insonorisant
<i>Schalldämmende Matte</i> ④ Vertical stud
Montant structurel
<i>Tragender Pfosten</i> ⑤ Aluminium cover
Profil de départ en aluminium
<i>Abschlußprofil aus Aluminium</i> ⑥ Head/floor channel
Goulotte de fermeture
<i>Verschlusskanal</i> | <ul style="list-style-type: none"> ⑦ Factory made cutout for ventilation control
Usinage panneau pour cache boîte
<i>Paneelbearbeitung für eingebautes Element</i> ⑧ Flush mounted box
Câche boîte
<i>Eingebautes Element</i> ⑨ Ventilation control
Contrôle ventilation
<i>Steuerungschalter für Belüftung</i> ⑩ Power/data module (optional)
Multiprise électrique et données (option)
<i>Elektro- und Datenanschluss (optional)</i> |
|--|--|

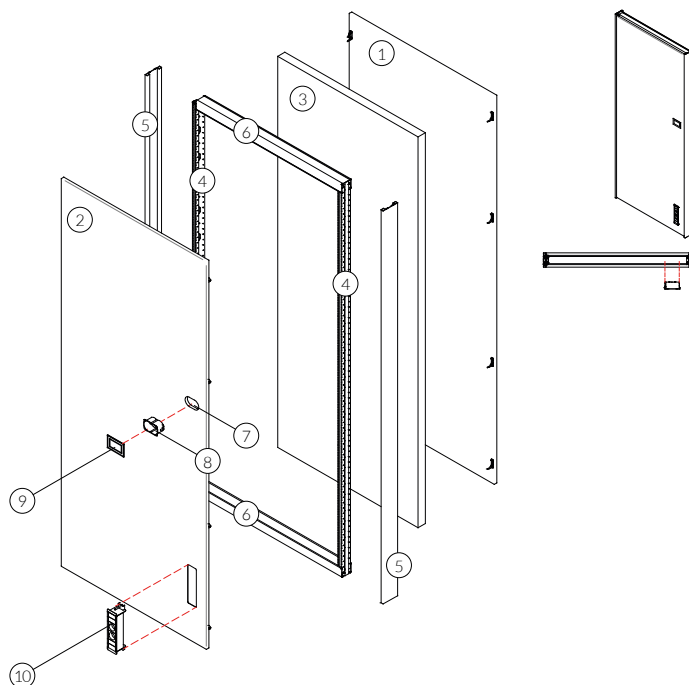

UPHOLSTERED SOLID WALL PANEL WITH SWITCH POST AND VENTILATION / CLOISON PLEINE PANNEAU EN TISSU VERTICAL AVEC MODULE TECHNIQUE / GESCHLOSSENE WANDSTRECKE MIT VERTIKALEN STOFFPANELEN MIT TECHNISCHEM MODUL

- | | |
|--|---|
| <ul style="list-style-type: none"> ① Melamine external panel
Panneau extérieur en mélaminé
<i>Außeres Paneel aus Melamin</i> ② Acoustic fully upholstered internal panel
Panneau interne tissu acoustique
<i>Akustisch inneres Paneel stoffbezogen</i> ③ Sound absorbing material
Matelas insonorisant
<i>Schalldämmende Matte</i> ④ Vertical stud
Montant structurel
<i>Tragender Pfosten</i> ⑤ Head/floor channel
Goulotte de fermeture
<i>Verschlusskanal</i> ⑥ Aluminium cover
Profil de départ en aluminium
<i>Abschlußprofil aus Aluminium</i> | <ul style="list-style-type: none"> ⑦ Acoustic fully upholstered switch post
Module technique revêtu en tissu
<i>Technisches Modul mit Stoffbezug</i> ⑧ Vertical stud for switch post
Montant structurel pour module technique
<i>Tragender Pfosten für technisches Modul</i> ⑨ Ventilation control
Contrôle ventilation
<i>Steuerungschalter für Belüftung</i> ⑩ Power/data module (optional)
Multiprise électrique et données (option)
<i>Elektro- und Datenanschluss (optional)</i> |
|--|---|

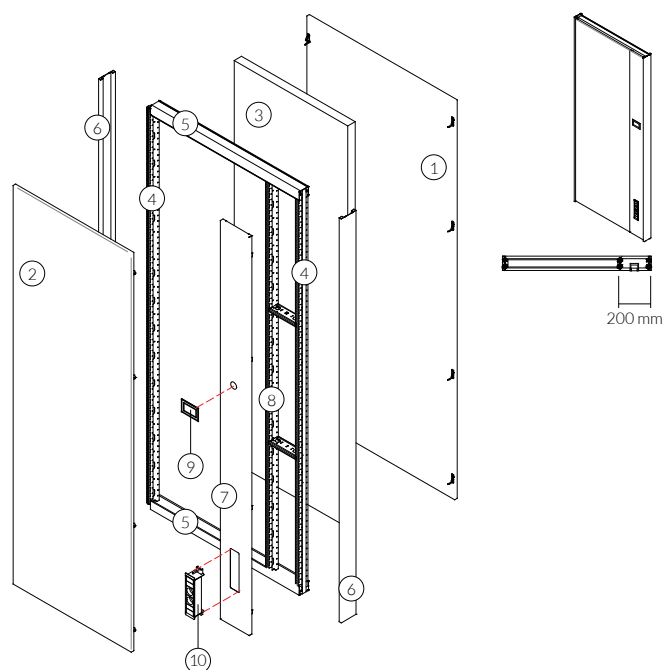

SHELF FOR SOLID WALL PANELS/ ETAGÈRE POUR MODULE PLEIN/ FACHBODEN FÜR GESCHLOSSENE MODULE

Melamine, veneered, lacquered melamine shelf. To be used with solid melamine or upholstered wall panels. Height adjustable in increments of 32mm.

Etagère mélaminé, mélaminé laqué ou placage bois, pour cloisons pleins ou en tissu acoustique; positionnable en hauteur tous les 32 mm.

Fachboden aus Melamin, lackiertem oder furniertem Melamin, für geschlossene Wandstrecke (Melamin oder Stoff); alle 32 mm in der Höhe einstellbar.

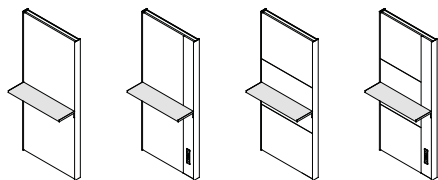
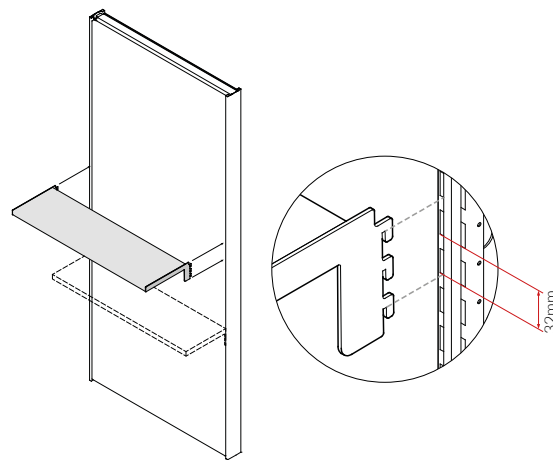

Recommended height from floor level: 1100mm
Hauteur recommandée: 1100 mm
Empfohlene Fachbodenhöhe: 1100 mm

WRITABLE WHITEBOARD/ TABLEAU EFFACABLE/ WHITEBOARD (BESCHREIBBAR)

Writable whiteboard factory-fitted on melamine, veneered or lacquered melamine panels. Glossy polyester white surface. Metal tray with four board pens and eraser available as an optional extra.

Film inscriptible pour application sur panneau mélaminé, mélaminé laqué et placage bois. Kit porte-marqueur en tôle d'acier pliée et peinte, 4 marqueurs colorés et une gomme (en option).

Beschreibbare Folie zur Aufklebung auf Melaminplatte, lackiertem Melamin und Holzfurnier. Optionaler Ausrüstungssatz: Behälter für Filzstifte (aus gebogenem und lackiertem Stahlblech), 4 farbige Filzstifte und Radiergummi.

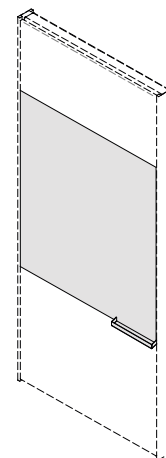

SEATING/ BANC/ SITZBANK

Inner frame made from beech plywood. Seat and back in polyurethane foam. 20x20mm powder coated 2mm steel tube frame on polyethylene glides.

Structure interne en contreplaqué de hêtre. Assise et dossier en mousse polyuréthane sectionnée par bloc. Pieds en tube d'acier de section 20x20, ép. 2 mm, verni avec poudres époxy; pieds en polyéthylène.

Sitzkörper aus mehrschichtigem Buchenholz. Sitz und Rückenlehne aus Polyurethanschaum mit Blockteilung. Beine aus Stahlrohrprofil 20x20, 2 mm stark, epoxidpulverbeschichtet; Füße aus Polyethylen.

Legs
Pieds
Beine

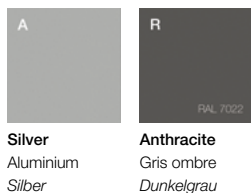

NORMS/ RÉFÉRENCES NORMATIVES/ GESETZLICHE VORSCHRIFTEN

UNI EN ISO 11957:2009

Acoustics - Determination of sound insulation performance of cabins. Laboratory and in situ measurements.

Acoustique - Détermination des performances d'insonorisation des cabines - Prise des mesures en laboratoire et sur site.

Akustik. Bestimmung der Schalldämmleistung von Kabinen. Messungen im Labor und auf Baustelle.

UNI EN ISO 717-1:2013

Acoustics - Rating of sound insulation in buildings and of building elements. Part 1: airborne sound insulation.

Acoustique - Évaluation de l'isolation acoustique dans les immeubles et les éléments des bâtiments - Partie 1: Isolation acoustique par voie aérienne.

Akustik. Beurteilung der Schalldämmung von Gebäuden und Bauteilen. Teil 1: Luftschalldämmung.

UNI EN ISO 3741:2010

Acoustics - Determination of sound power levels and sound energy levels of noise sources using sound pressure. Precision methods for reverberation test rooms.

Acoustique - Détermination des niveaux de puissance acoustique et des niveaux d'énergie acoustique émis par les sources de bruit en mesurant la pression acoustique - Méthodes de laboratoire en salles réverbérantes.

Akustik. Bestimmung von Schalleistungspegeln und Schallenergiepegeln von Schallquellen durch Schalldruckmessung. Laborverfahren in Hallräumen.

UNI EN ISO 354:2003

Acoustics - Measurement of sound absorption in a reverberation room.

Acoustique - Mesure de l'absorption acoustique dans une salle réverbérante.

Akustik. Messung der Schallabsorption in Hallräumen.

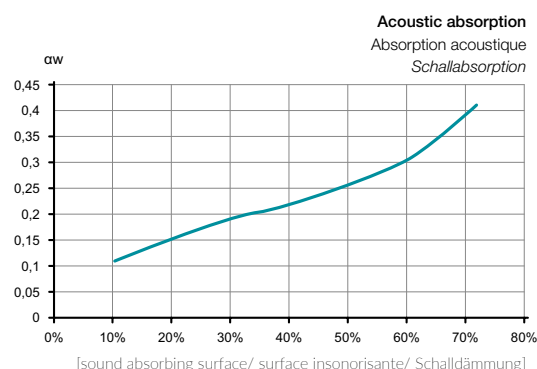
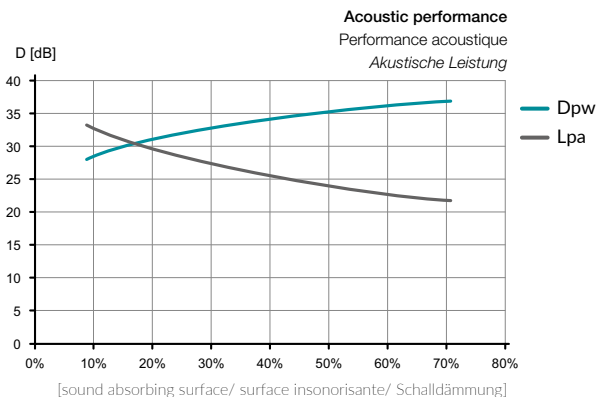
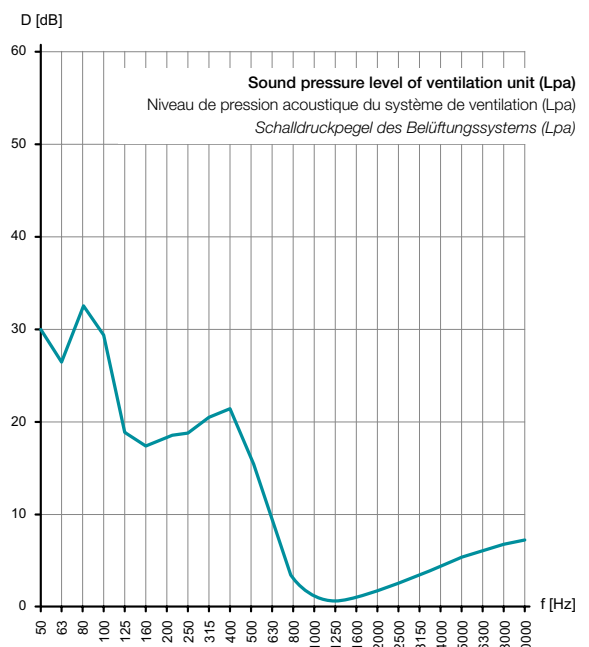
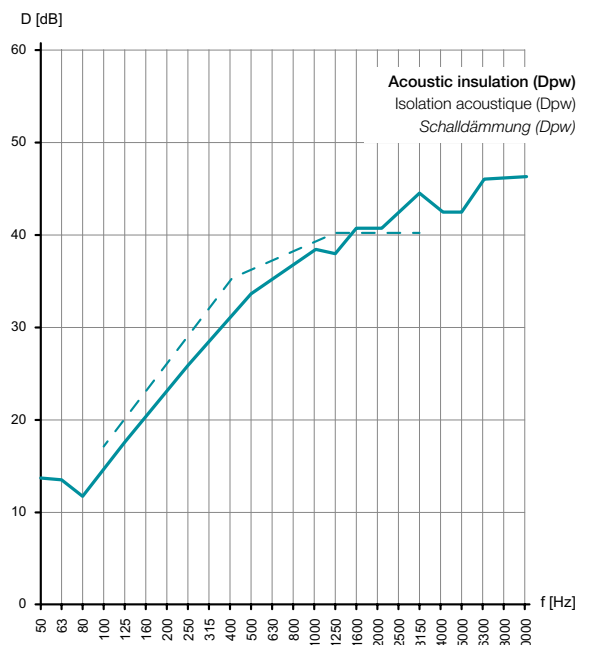
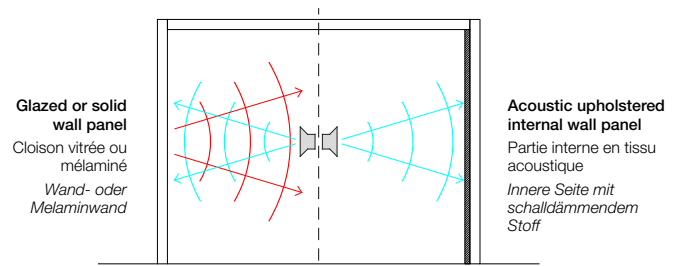

Shapes and sizes

Layout

Modularität

1X1

Internal usable size: 1034 x 1034 x 2290
External size: 1236 x 1236 x 2440

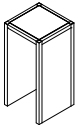
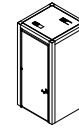

2X1

Internal usable size: 2034 x 1034 x 2290
External size: 2236 x 1236 x 2440

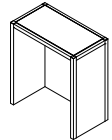
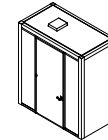
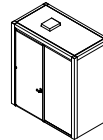

2X2

Internal usable size: 2034 x 2034 x 2290
External size: 2236 x 2236 x 2440

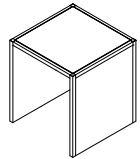
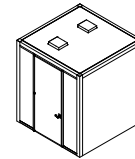
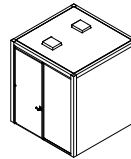

2X3

Internal usable size: 2034 x 3034 x 2290
External size: 2236 x 3236 x 2440

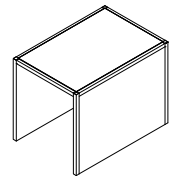
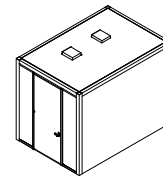
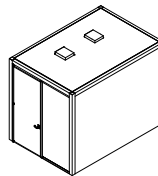

3X2

Internal usable size: 3034 x 2034 x 2290
External size: 3236 x 2236 x 2440

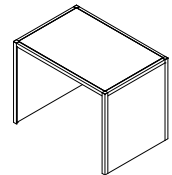
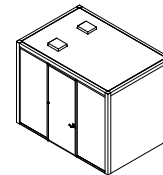
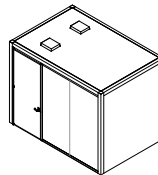

3X3

Internal usable size: 3034 x 3034 x 2290
External size: 3236 x 3236 x 2440

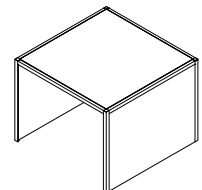
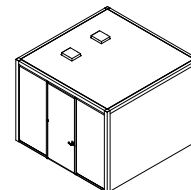
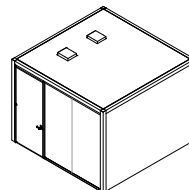

3X4

Internal usable size: 3034 x 4034 x 2290
External size: 3236 x 4236 x 2440

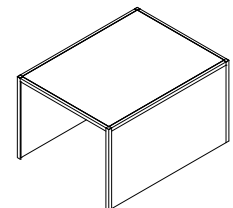
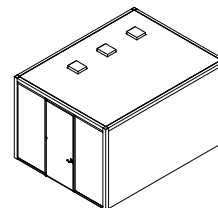
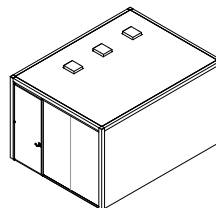

4X3

Internal usable size: 4034 x 3034 x 2290
External size: 4236 x 3236 x 2440

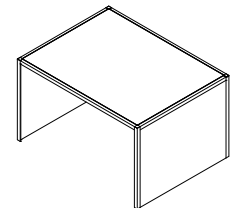
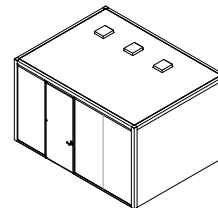
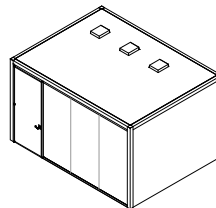

Cod. PBM11006

M1V0002	M1C0002	M1C0012	M1T0002	M1T0012	M1TT002	M1TT012							
M1V0003	M1C0003	M1C0013	M1T0003	M1T0013	M1TT003	M1TT013							
M1PDH04	M1PDA04	M1PSH04	M1PSA04	M1TX003									

PLEASE NOTE: at least one solid wall panel is mandatory
 ATTENTION: Un côté plein toujours obligatoire
 WARNUNG: Eine geschlossene Wandstrecke ist immer erforderlich

					Frosted glass Verre dépoli Safinertes Glas		Tracks in anthracite Profils gris anthracite Profile Dunkelgrau		Tracks in RAL of your choice Profils RAL au choix Profile nach RAL Farbkarte		Lacquered solid wall (1 side) Panneau RAL (1 côté) Paneeel lackiert (einseitig)		Wood veneer solid wall (1 side) Panneau mélaminé (1 côté) Holzpaneeel (einseitig)		Multiple-socket Multiprise Elektrifizierung			
1	2	3	4	5								EU (type F)	USA (type A)					
												S	L	S	L			
1869	-	1869	-	-	+ 516	+ 130	+ 384	-	-	-	-	-	-	-	-	-	-	
-	2626	-	-	-	+ 774	+ 181	+ 534	-	-	-	-	-	-	-	-	-	-	
1328	-	1328	-	-	-	2x + 97	+ 285	+ 511	+ 2090	+ 331	+ 381	+ 376	+ 426	-	-	-	-	
1518	-	1518	-	-	-	+ 97	+ 285	+ 523	+ 2102	+ 331	+ 381	+ 376	+ 426	-	-	-	-	
2365	-	2365	-	-	-	+ 97	+ 285	-	-	-	-	-	-	-	-	-	-	
3049	-	3049	-	-	-	+ 97	+ 285	-	-	-	-	-	-	-	-	-	-	
2655	-	2655	-	-	-	+ 97	+ 285	-	-	+ 351	+ 401	+ 396	+ 446	-	-	-	-	
3340	-	3340	-	-	-	+ 97	+ 285	-	-	+ 351	+ 401	+ 396	+ 446	-	-	-	-	
-	1703	-	-	-	-	+ 107	+ 315	+ 766	+ 3135	+ 331	+ 381	+ 376	+ 426	-	-	-	-	
-	1883	-	-	-	-	+ 107	+ 315	+ 784	+ 3153	+ 331	+ 381	+ 376	+ 426	-	-	-	-	
-	3258	-	-	-	-	+ 107	+ 315	-	-	-	-	-	-	-	-	-	-	
-	5208	-	-	-	-	+ 107	+ 315	-	-	-	-	-	-	-	-	-	-	
-	3549	-	-	-	-	+ 107	+ 315	-	-	+ 351	+ 401	+ 396	+ 446	-	-	-	-	
-	5498	-	-	-	-	+ 107	+ 315	-	-	+ 351	+ 401	+ 396	+ 446	-	-	-	-	
-	-	-	3449	-	+ 716	+ 231	+ 573	-	-	-	-	-	-	-	-	-	-	
-	-	-	3449	-	+ 716	+ 231	+ 573	-	-	-	-	-	-	-	-	-	-	
-	-	-	3449	-	+ 716	+ 231	+ 573	-	-	-	-	-	-	-	-	-	-	
-	-	-	156	-	-	+ 138	+ 405	-	-	-	-	-	-	-	-	-	-	
-	-	-	-	7511	-	-	-	-	-	-	-	-	-	-	-	-	-	
-	-	-	-	9015	-	-	-	-	-	-	-	-	-	-	-	-	-	
-	-	-	-	3671	-	-	-	-	-	-	-	-	-	-	-	-	-	
-	-	-	-	5174	-	-	-	-	-	-	-	-	-	-	-	-	-	

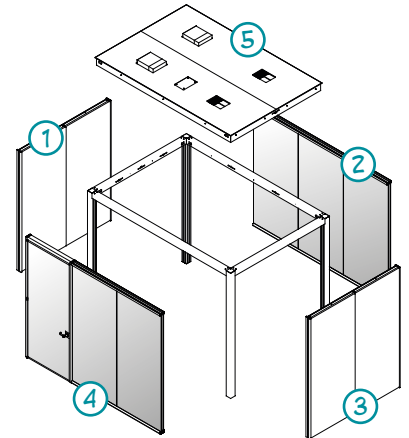

- ① 1x M1C0002 1328 +
1x RAL 7022 97 +
- ② 1x M1V0003 2626 +
1x RAL 7022 181 +
- ③ 1x M1C0002 1328 +
1x RAL 7022 97 +
1x EU 331 +
- ④ 1x M1PSH04 3449 +
1x RAL 7022 231 +
- ⑤ 1x MXST007 9015 =

TOTAL 18.683

How to complete an order form Composition module commande Ausfüllen des Bestellformulars

Booth code / Code composition/ Code der Zusammensetzung

PBM11006

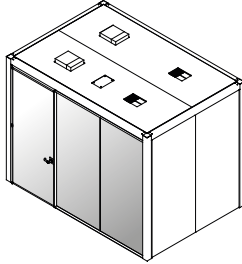

At least one solid wall panel is mandatory

Un côté plein toujours obligatoire

Eine geschlossene Wandstrecke ist erforderlich

	ITEM CODE CODE SECTION WANDSTRECKENUMMER	FINISH OPTIONS / FINITIONS / AUSFÜHRUNGEN				MULTIPLE-SOCKETS / MULTIPRISES / MEHRFACHSTECKDOSEN				Position Position Position
		Internal Interne Innen	External Externe Außen	Frosted glass (*) Verre dépoli (*) Satiertes Glas (*)	Tracks in RAL (*) Profils RAL (*) Profile RAL (*)	EU		UK/USA		
						S	L	S	L	
①	M1C0002		GR		RAL 7022					
②	M1V0003				RAL 7022					
③	M1C0002		GR		RAL 7022	x				A
④	M1P3H04				RAL 7022					
⑤	MX5T007	B01/OZ1		-	-	-	-	-	-	-

(*) upcharge
(*) majoration
(*) Zuschlag

Fabric Tissu Stoff		
Melamine Mélaminé Melamin		
Laquered (*) Laqué (*) Lackiertes Melamin (*)		
Wood veneer (*) Placage bois (*) Furniertes Holz (*)		

Only for solid wall panels or upholstered wall panels with switch post

Uniquement pour section panneau ou section tissu avec module technique

Nur für Melamin- oder Stoffpaneel mit technischem Modul

Please specify desired position of power modules (A, B, C, D, E, F) as shown in the price list

Préciser la position des prises (A, B, C, D, E, F) comme indiqué dans le tarif

Geben Sie die Position der Steckdosen (A, B, C, D, E, F) wie in der Preisliste angegeben an.

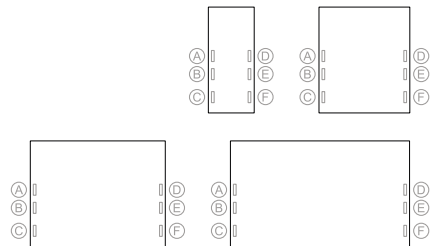

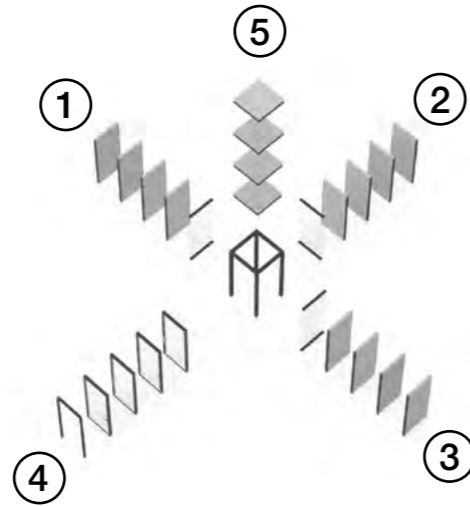
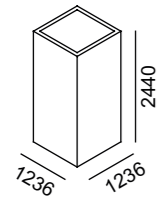
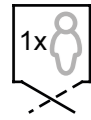

Cod. PBM11001

		1x1 acoustic booth					Frosted glass			Tracks in anthracite		Tracks in RAL of your choice		Lacquered solid wall (1 side)		Wood veneer solid wall (1 side)		Power modules / Multipriees / Mehrfachsteckdosen					
		1	2	3	4	5	Verre dépoli	Satinierendes Glas	Profilis gris ombre	Profilie Dunkelgrau	Profilis RAL au choix	Profilie nach RAL Farbkarte	Panneau RAL (1 côté)	Panneel lackiert (einseitig)	Panneau mélamin (1 côté)	Holzpaneel (einseitig)	EU (type F)		UK (type G)				
																S	L	S	L				
M1V0001	1m single glazed wall/ Section vitrée 1m simple vitrage/ Wandstrecke 1 mt mit einfachem Glas	1168	1168	1168	-	-	+271	+83	+246	-	-	-	-	-	-	-	-	-	-	-	-	-	-
M1C0001	1m solid wall/ Section panneau 1m vertical/ Geschlossene Melaminwandstrecke 1 mt breit vertikal	1001	1001	1001	-	-	-	+91	+268	+268	+1097	+348	+400	+395	+447								
M1C0011	1m tiled solid wall/ Section panneau 1m horizontal/ Geschlossene Melaminwandstrecke 1 mt breit horizontal	1064	1064	1064	-	-	-	+91	+268	+274	+1104	+348	+400	+395	+447								
M1T0001	1m solid wall, inner upholstery/ Section tissu 1m vertical/ Stoffwandstrecke 1 mt vertikal	1545	1545	1545	-	-	-	+91	+268	-	-	-	-	-	-	-	-	-	-	-	-	-	-
M1T0011	1m tiled solid wall, inner upholstery/ Section tissu 1m horizontal/ Stoffwandstrecke 1 mt horizontal	2227	2227	2227	-	-	-	+91	+268	-	-	-	-	-	-	-	-	-	-	-	-	-	-
M1TT001	1m solid wall, switch post, inner upholstery/ Section tissu 1m vertical avec module technique/ Stoffwandstrecke 1 mt vertikal mit Technikmodul	1850	1850	1850	-	-	-	+91	+268	-	-	+369	+421	+416	+468								
M1TT011	1m tiled solid wall, switch post, inner upholstery/ Section tissu 1m horizontal avec module technique/ Stoffwandstrecke 1 mt horizontal mit Technikmodul	2533	2533	2533	-	-	-	+91	+268	-	-	+369	+421	+416	+468								
M1PDH01	1m glazed RH door, HCS handle/ Section porte tirant droite, poignée HCS, 1m/ Wandstrecke 1 mt mit rechter Tür Griff HCS	-	-	-	2032	-	+210	+135	+287	-	-	-	-	-	-	-	-	-	-	-	-	-	-
M1PDA01	1m glazed RH door, AGB handle/ Section porte tirant droite, poignée AGB, 1m/ Wandstrecke 1 mt mit rechter Tür Griff AGB	-	-	-	2032	-	+210	+135	+287	-	-	-	-	-	-	-	-	-	-	-	-	-	-
M1PSH01	1m glazed LH door, HCS handle/ Section porte tirant gauche, poignée HCS, 1m/ Wandstrecke 1 mt mit linker Tür Griff HCS	-	-	-	2032	-	+210	+135	+287	-	-	-	-	-	-	-	-	-	-	-	-	-	-
M1PSA01	1m glazed LH door, AGB handle/ Section porte tirant gauche, poignée AGB, 1m/ Wandstrecke 1 mt mit linker Tür Griff AGB	-	-	-	2032	-	+210	+135	+287	-	-	-	-	-	-	-	-	-	-	-	-	-	-
M1TX001	1m open side/ Section ouverte 1m/ Offene Wandstrecke 1 Mt breit	-	-	-	156	-	-	+102	+299	-	-	-	-	-	-	-	-	-	-	-	-	-	-
MXSM001	1m x 1m solid ceiling with ventilation/ Plafond en panneau avec aération 1m x 1m/ Melamindecke inkl. Belüftung 1 mt x 1 mt	-	-	-	-	3376	-	-	-	-	-	-	-	-	-	-	-	-	-	-	-	-	-
MXST001	1m x 1m upholstered ceiling with ventilation/ Plafond en tissu avec aération 1m x 1m/ Stoffdecke inkl. Belüftung 1 mt x 1 mt	-	-	-	-	3963	-	-	-	-	-	-	-	-	-	-	-	-	-	-	-	-	-
MXSM002	1m x 1m solid ceiling without ventilation/ Plafond en panneau sans aération 1m x 1m/ Melamindecke ohne Belüftung 1 mt x 1 mt	-	-	-	-	2065	-	-	-	-	-	-	-	-	-	-	-	-	-	-	-	-	-
MXST002	1m x 1m upholstered ceiling without ventilation/ Plafond en tissu sans aération 1m x 1m/ Stoffdecke ohne Belüftung 1 mt x 1 mt	-	-	-	-	2652	-	-	-	-	-	-	-	-	-	-	-	-	-	-	-	-	-

PLEASE NOTE: at least one solid wall panel is mandatory
ATTENTION: Un côté plein toujours obligatoire
WARNUNG: Eine geschlossene Wandstrecke ist immer erforderlich

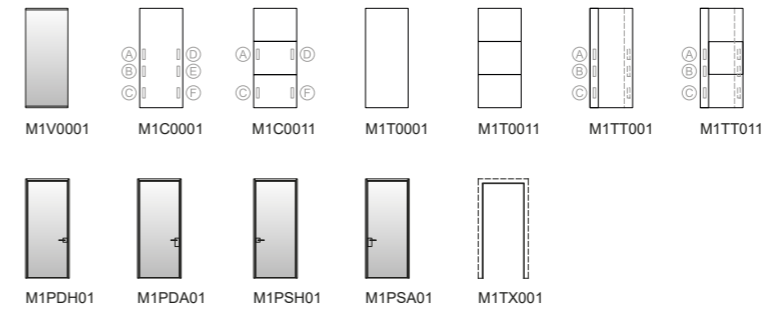

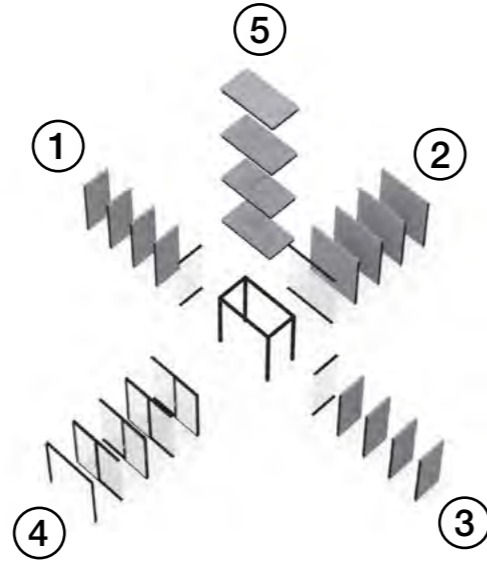
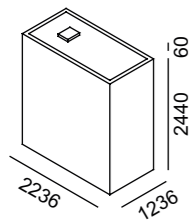
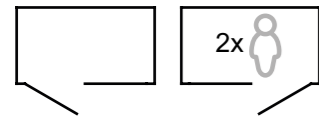

Cod. PBM11002

Code	Description	Wall Panels					Glass & Tracks			Lacquered Solid Wall		Wood Veneer Solid Wall		Power modules / Multiprisen / Mehrfachsteckdosen				
		1	2	3	4	5	Frosted glass	Tracks in anthracite	Tracks in RAL of your choice	S	L	S	L	S	L	S	L	
M1V0001	1m single glazed wall/ Section vitrée 1m simple vitrage/ Wandstrecke 1 mt mit einfachem Glas	1168	-	1168	-	-	+271	+83	+246	-	-	-	-	-	-	-	-	-
M1V0002	2m single glazed wall/ Section vitrée 2m simple vitrage/ Wandstrecke 2 mt mit einfachem Glas	-	1962	-	-	-	+542	+137	+403	-	-	-	-	-	-	-	-	-
M1C0001	1m solid wall/ Section panneau 1m vertical/ Geschlossene Melaminwandstrecke 1 mt breit vertikal	1001	-	1001	-	-	-	+91	+268	+268	+1097	+348	+400	+395	+447	-	-	-
M1C0011	1m tiled solid wall/ Section panneau 1m horizontal/ Geschlossene Melaminwandstrecke 1 mt breit horizontal	1064	-	1064	-	-	-	+91	+268	+274	+1104	+348	+400	+395	+447	-	-	-
M1T0001	1m solid wall, inner upholstery/ Section tissu 1m vertical/ Stoffwandstrecke 1 mt vertikal	1545	-	1545	-	-	-	+91	+268	-	-	-	-	-	-	-	-	-
M1T0011	1m tiled solid wall, inner upholstery/ Section tissu 1m horizontal/ Stoffwandstrecke 1 mt horizontal	2227	-	2227	-	-	-	+91	+268	-	-	-	-	-	-	-	-	-
M1TT001	1m solid wall, switch post, inner upholstery/ Section tissu 1m vertical avec module technique/ Stoffwandstrecke 1 mt vertikal mit Technikmodul	1850	-	1850	-	-	-	+91	+268	-	-	+369	+421	+416	+468	-	-	-
M1TT011	1m tiled solid wall, switch post, inner upholstery/ Section tissu 1m horizontal avec module technique/ Stoffwandstrecke 1 mt horizontal mit Technikmodul	2533	-	2533	-	-	-	+91	+268	-	-	+369	+421	+416	+468	-	-	-
M1C0002	2m solid wall/ Section panneau 2m vertical/ Geschlossene Melaminwandstrecke 2 mt breit vertikal	-	1394	-	-	-	-	+102	+299	+537	+2195	+348	+400	+395	+447	-	-	-
M1C0012	2m tiled solid wall/ Section panneau 2m horizontal/ Geschlossene Melaminwandstrecke 2 mt breit horizontal	-	1594	-	-	-	-	+102	+299	+549	+2207	+348	+400	+395	+447	-	-	-
M1T0002	2m solid wall, inner upholstery/ Section tissu 2m vertical/ Stoffwandstrecke 2 mt vertikal	-	2483	-	-	-	-	+102	+299	-	-	-	-	-	-	-	-	-
M1T0012	2m tiled solid wall, inner upholstery/ Section tissu 2m horizontal/ Stoffwandstrecke 2 mt horizontal	-	3201	-	-	-	-	+102	+299	-	-	-	-	-	-	-	-	-
M1TT002	2m solid wall, switch post, inner upholstery/ Section tissu 2m vertical avec module technique/ Stoffwandstrecke 2 mt vertikal mit Technikmodul	-	2788	-	-	-	-	+102	+299	-	-	+369	+421	+416	+468	-	-	-
M1TT012	2m tiled solid wall, switch post, inner upholstery/ Section tissu 2m horizontal avec module technique/ Stoffwandstrecke 2 mt horizontal mit Technikmodul	-	3507	-	-	-	-	+102	+299	-	-	+369	+421	+416	+468	-	-	-
M1PDH02	2m glazed RH door, HCS handle/ Section porte tirant droite, poignée HCS, 2m/ Wandstrecke 2 mt mit rechter Tür Griff HCS	-	-	-	2827	-	+481	+189	+444	-	-	-	-	-	-	-	-	-
M1PDA02	2m glazed RH door, AGB handle/ Section porte tirant droite, poignée AGB, 2m/ Wandstrecke 2 mt mit rechter Tür Griff AGB	-	-	-	2827	-	+481	+189	+444	-	-	-	-	-	-	-	-	-
M1PSH02	2m glazed LH door, HCS handle/ Section porte tirant gauche, poignée HCS, 2m/ Wandstrecke 2 mt mit linker Tür Griff HCS	-	-	-	2827	-	+481	+189	+444	-	-	-	-	-	-	-	-	-
M1PSA02	2m glazed LH door, AGB handle/ Section porte tirant gauche, poignée AGB, 2m/ Wandstrecke 2 mt mit linker Tür Griff AGB	-	-	-	2827	-	+481	+189	+444	-	-	-	-	-	-	-	-	-
M1TX002	2m open side/ Section ouverte 2m/ Offene Wandstrecke 2 Mt breit	-	-	-	161	-	-	+123	+362	-	-	-	-	-	-	-	-	-
MXSM003	2m x 1m solid ceiling with ventilation/ Plafond en panneau avec aération 2m x 1m/ Melamindecke inkl. Belüftung 2 mt x 1 mt	-	-	-	-	4711	-	-	-	-	-	-	-	-	-	-	-	-
MXST003	2m x 1m upholstered ceiling with ventilation/ Plafond en tissu avec aération 2m x 1m/ Stoffdecke inkl. Belüftung 2 mt x 1 mt	-	-	-	-	5633	-	-	-	-	-	-	-	-	-	-	-	-
MXSM004	2m x 1m solid ceiling without ventilation/ Plafond en panneau sans aération 2m x 1m/ Melamindecke ohne Belüftung 2 mt x 1 mt	-	-	-	-	2448	-	-	-	-	-	-	-	-	-	-	-	-
MXST004	2m x 1m upholstered ceiling without ventilation/ Plafond en tissu sans aération 2m x 1m/ Stoffdecke ohne Belüftung 2 mt x 1 mt	-	-	-	-	3368	-	-	-	-	-	-	-	-	-	-	-	-

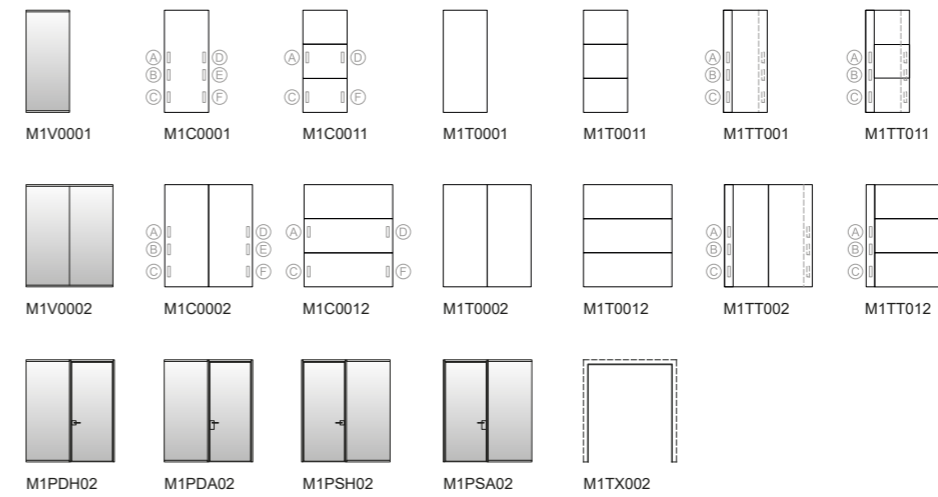

PLEASE NOTE: at least one solid wall panel is mandatory
ATTENTION: Un côté plein toujours obligatoire
WARNUNG: Eine geschlossene Wandstrecke ist immer erforderlich

1 2 3 4 5

Frosted glass	Tracks in anthracite	Tracks in RAL of your choice	Lacquered solid wall (1 side)	Wood veneer solid wall (1 side)	Power modules / Multiprisen / Mehrfachsteckdosen				
					EU (type F)	UK (type G)	USA (type A)		
S	L	S	L	S	L	S	L	S	L
+271	+83	+246	-	-	-	-	-	-	-
+542	+137	+403	-	-	-	-	-	-	-
-	+91	+268	+268	+1097	+348	+400	+395	+447	-
-	+91	+268	+274	+1104	+348	+400	+395	+447	-
-	+91	+268	-	-	-	-	-	-	-
-	+91	+268	-	-	+369	+421	+416	+468	-
-	+91	+268	-	-	+369	+421	+416	+468	-
-	+102	+299	+537	+2195	+348	+400	+395	+447	-
-	+102	+299	+549	+2207	+348	+400	+395	+447	-
-	+102	+299	-	-	-	-	-	-	-
-	+102	+299	-	-	+369	+421	+416	+468	-
-	+102	+299	-	-	+369	+421	+416	+468	-
+481	+189	+444	-	-	-	-	-	-	-
+481	+189	+444	-	-	-	-	-	-	-
+481	+189	+444	-	-	-	-	-	-	-
+481	+189	+444	-	-	-	-	-	-	-
-	+123	+362	-	-	-	-	-	-	-
-	-	-	-	-	-	-	-	-	-
-	-	-	-	-	-	-	-	-	-
-	-	-	-	-	-	-	-	-	-

2x1 acoustic booth - door in the middle of 2m wall
 Cabine acoustique 2x1 - porte côté 2 mètres centrale
 Akustikkabine 2 mt x 1 mt - mittige Tür auf 2 mt Seite

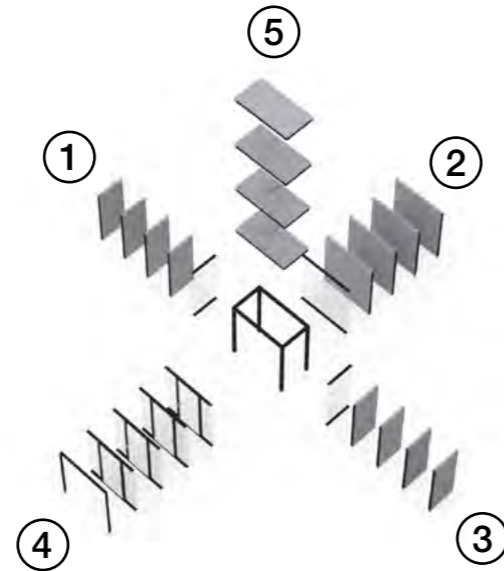
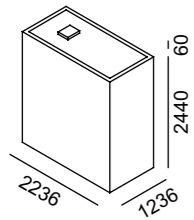
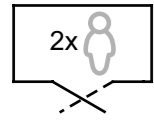

Cod. PBM11003

Cod.	Description	Configuration					Glass / Tracks			Lacquered solid wall (1 side)		Wood veneer solid wall (1 side)		Power modules / Multiprises / Mehrfachsteckdosen			
		1	2	3	4	5	Frosted glass	Tracks in anthracite	Tracks in RAL of your choice	S	L	S	L	EU (type F)	USA (type A)	S	L
M1V0001	1m single glazed wall/ Section vitrée 1m simple vitrage/ Wandstrecke 1 mt mit einfachem Glas	1168	-	1168	-	-	+271	+83	+246	-	-	-	-	-	-	-	-
M1V0002	2m single glazed wall/ Section vitrée 2m simple vitrage/ Wandstrecke 2 mt mit einfachem Glas	-	1962	-	-	-	+542	+137	+403	-	-	-	-	-	-	-	
M1C0001	1m solid wall/ Section panneau 1m vertical/ Geschlossene Melaminwandstrecke 1 mt breit vertikal	1001	-	1001	-	-	-	+91	+268	+268	+1097	+348	+400	+395	+447	-	
M1C0011	1m tiled solid wall/ Section panneau 1m horizontal/ Geschlossene Melaminwandstrecke 1 mt breit horizontal	1064	-	1064	-	-	-	+91	+268	+274	+1104	+348	+400	+395	+447	-	
M1T0001	1m solid wall, inner upholstery/ Section tissu 1m vertical/ Stoffwandstrecke 1 mt vertikal	1545	-	1545	-	-	-	+91	+268	-	-	-	-	-	-	-	
M1T0011	1m tiled solid wall, inner upholstery/ Section tissu 1m horizontal/ Stoffwandstrecke 1 mt horizontal	2227	-	2227	-	-	-	+91	+268	-	-	-	-	-	-	-	
M1TT001	1m solid wall, switch post, inner upholstery/ Section tissu 1m vertical avec module technique/ Stoffwandstrecke 1 mt vertikal mit Technikmodul	1850	-	1850	-	-	-	+91	+268	-	-	+369	+421	+416	+468	-	
M1TT011	1m tiled solid wall, switch post, inner upholstery/ Section tissu 1m horizontal avec module technique/ Stoffwandstrecke 1 mt horizontal mit Technikmodul	2533	-	2533	-	-	-	+91	+268	-	-	+369	+421	+416	+468	-	
M1C0002	2m solid wall/ Section panneau 2m vertical/ Geschlossene Melaminwandstrecke 2 mt breit vertikal	-	1394	-	-	-	-	+102	+299	+537	+2195	+348	+400	+395	+447	-	
M1C0012	2m tiled solid wall/ Section panneau 2m horizontal/ Geschlossene Melaminwandstrecke 2 mt breit horizontal	-	1594	-	-	-	-	+102	+299	+549	+2207	+348	+400	+395	+447	-	
M1T0002	2m solid wall, inner upholstery/ Section tissu 2m vertical/ Stoffwandstrecke 2 mt vertikal	-	2483	-	-	-	-	+102	+299	-	-	-	-	-	-	-	
M1T0012	2m tiled solid wall, inner upholstery/ Section tissu 2m horizontal/ Stoffwandstrecke 2 mt horizontal	-	3201	-	-	-	-	+102	+299	-	-	-	-	-	-	-	
M1TT002	2m solid wall, switch post, inner upholstery/ Section tissu 2m vertical avec module technique/ Stoffwandstrecke 2 mt vertikal mit Technikmodul	-	2788	-	-	-	-	+102	+299	-	-	+369	+421	+416	+468	-	
M1TT012	2m tiled solid wall, switch post, inner upholstery/ Section tissu 2m horizontal avec module technique/ Stoffwandstrecke 2 mt horizontal mit Technikmodul	-	3507	-	-	-	-	+102	+299	-	-	+369	+421	+416	+468	-	
M1PDH03	2m wall with middle RH door, HCS handle/ Section porte tirant droite, poignée HCS, 2m centrale/ Wandstrecke 2 mt mit mittiger rechten Tür Griff HCS	-	-	-	2932	-	+481	+189	+444	-	-	-	-	-	-	-	
M1PDA03	2m wall with middle RH door, AGB handle/ Section porte tirant droite, poignée AGB, 2m centrale/ Wandstrecke 2 mt mit mittiger rechten Tür Griff AGB	-	-	-	2932	-	+481	+189	+444	-	-	-	-	-	-	-	
M1PSH03	2m wall with middle LH door, HCS handle/ Section porte tirant gauche, poignée HCS, 2m centrale/ Wandstrecke 2 mt mit mittiger linken Tür Griff HCS	-	-	-	2932	-	+481	+189	+444	-	-	-	-	-	-	-	
M1PSA03	2m wall with middle LH door, AGB handle/ Section porte tirant gauche, poignée AGB, 2m centrale/ Wandstrecke 2 mt mit mittiger linken Tür Griff AGB	-	-	-	2932	-	+481	+189	+444	-	-	-	-	-	-	-	
M1TX002	2m open side/ Section ouverte 2m/ Offene Wandstrecke 2 Mt breit	-	-	-	161	-	-	+123	+362	-	-	-	-	-	-	-	
MXSM003	2m x 1m solid ceiling with ventilation/ Plafond en panneau avec aération 2m x 1m/ Melamindecke inkl. Belüftung 2 mt x 1 mt	-	-	-	-	4711	-	-	-	-	-	-	-	-	-	-	
MXST003	2m x 1m upholstered ceiling with ventilation/ Plafond en tissu avec aération 2m x 1m/ Stoffdecke inkl. Belüftung 2 mt x 1 mt	-	-	-	-	5633	-	-	-	-	-	-	-	-	-	-	
MXSM004	2m x 1m solid ceiling without ventilation/ Plafond en panneau sans aération 2m x 1m/ Melamindecke ohne Belüftung 2 mt x 1 mt	-	-	-	-	2448	-	-	-	-	-	-	-	-	-	-	
MXST004	2m x 1m upholstered ceiling without ventilation/ Plafond en tissu sans aération 2m x 1m/ Stoffdecke ohne Belüftung 2 mt x 1 mt	-	-	-	-	3368	-	-	-	-	-	-	-	-	-	-	

2x1 acoustic booth - door in the middle of 2m wall
 Cabine acoustique 2x1 - porte côté 2 mètres centrale
 Akustikkabine 2 mt x 1 mt - mittige Tür auf 2 mt Seite

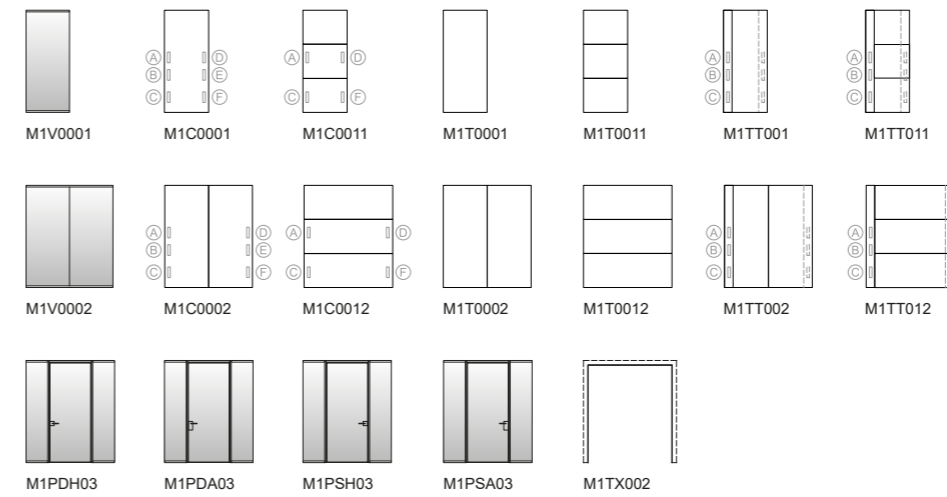

PLEASE NOTE: at least one solid wall panel is mandatory
 ATTENTION: Un côté plein toujours obligatoire
 WARNUNG: Eine geschlossene Wandstrecke ist immer erforderlich

1 2 3 4 5

Frosted glass	Tracks in anthracite	Tracks in RAL of your choice	Lacquered solid wall (1 side)	Wood veneer solid wall (1 side)	Power modules / Multiprises / Mehrfachsteckdosen			
					EU (type F)	USA (type A)	S	L
Verre dépoli Satinierendes Glas	Profils gris ombre Profile Dunkelgrau	Profils RAL au choix Profile nach RAL Farbkarte	Panneau RAL (1 côté) Panneel lackiert (einseitig)	Panneau mélaminé (1 côté) Holzpaneel (einseitig)	S	L	S	L

XChange

M1 - 2x2

2x2 acoustic booth
Cabine acoustique 2x2
Akustikkabine 2 mt x 2 mt

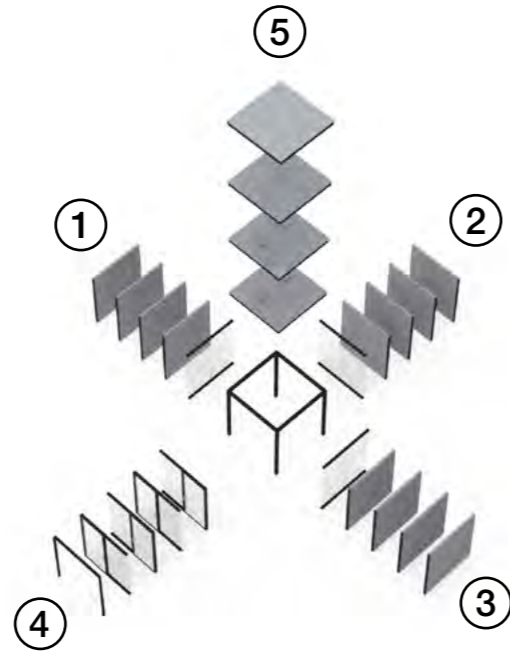
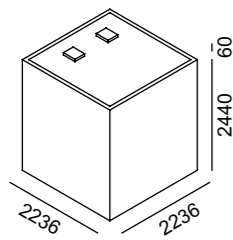
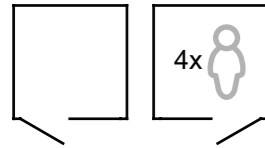

Cod. PBM11004

Code	Description	Position					Frosted glass Verre dépoli Satiniertes Glas	Tracks in anthracite Profilis gris ombre Profilie Dunkelgrau	Tracks in RAL of your choice Profilis RAL au choix Profilie nach RAL Farbkarte	Lacquered solid wall (1 side) Panneau RAL (1 côté) Panneel/lackiert (einseitig)	Wood veneer solid wall (1 side) Panneau mélaminé (1 côté) Holzpaneel (einseitig)	Power modules / Multiprises / Mehrfachsteckdosen			
		1	2	3	4	5						EU (type F) S L		UK (type G) USA (type A) S L	
M1V0002	2m single glazed wall/ Section vitrée 2m simple vitrage/ Wandstrecke 2 mt mit einfachem Glas	1962	1962	1962	-	-	+542	+137	+403	-	-	-	-	-	-
M1C0002	2m solid wall/ Section panneau 2m vertical/ Geschlossene Melaminwandstrecke 2 mt breit vertikal	1394	1394	1394	-	-	-	+102	+299	+537	+2195	+348	+400	+395	+447
M1C0012	2m tiled solid wall/ Section panneau 2m horizontal/ Geschlossene Melaminwandstrecke 2 mt breit horizontal	1594	1594	1594	-	-	-	+102	+299	+549	+2207	+348	+400	+395	+447
M1T0002	2m solid wall, inner upholstery/ Section tissu 2m vertical/ Stoffwandstrecke 2 mt vertikal	2483	2483	2483	-	-	-	+102	+299	-	-	-	-	-	-
M1T0012	2m tiled solid wall, inner upholstery/ Section tissu 2m horizontal/ Stoffwandstrecke 2 mt horizontal	3201	3201	3201	-	-	-	+102	+299	-	-	-	-	-	-
M1TT002	2m solid wall, switch post, inner upholstery/ Section tissu 2m vertical avec module technique/ Stoffwandstrecke 2 mt vertikal mit Technikmodul	2788	2788	2788	-	-	-	+102	+299	-	-	+369	+421	+416	+468
M1TT012	2m tiled solid wall, switch post, inner upholstery/ Section tissu 2m horizontal avec module technique/ Stoffwandstrecke 2 mt horizontal mit Technikmodul	3507	3507	3507	-	-	-	+102	+299	-	-	+369	+421	+416	+468
M1PDH02	2m glazed RH door, HCS handle/ Section porte tirant droite, poignée HCS, 2m/ Wandstrecke 2 mt mit rechter Tür Griff HCS	-	-	-	2827	-	+481	+189	+444	-	-	-	-	-	-
M1PDA02	2m glazed RH door, AGB handle/ Section porte tirant droite, poignée AGB, 2m/ Wandstrecke 2 mt mit rechter Tür Griff AGB	-	-	-	2827	-	+481	+189	+444	-	-	-	-	-	-
M1PSH02	2m glazed LH door, HCS handle/ Section porte tirant gauche, poignée HCS, 2m/ Wandstrecke 2 mt mit linker Tür Griff HCS	-	-	-	2827	-	+481	+189	+444	-	-	-	-	-	-
M1PSA02	2m glazed LH door, AGB handle/ Section porte tirant gauche, poignée AGB, 2m/ Wandstrecke 2 mt mit linker Tür Griff AGB	-	-	-	2827	-	+481	+189	+444	-	-	-	-	-	-
M1TX002	2m open side/ Section ouverte 2m/ Offene Wandstrecke 2 Mt breit	-	-	-	161	-	-	+123	+362	-	-	-	-	-	-
MXSM005	2m x 2m solid ceiling with ventilation/ Plafond en panneau avec aération 2m x 2m/ Melamindecke inkl. Belüftung 2 mt x 2 mt	-	-	-	-	6859	-	-	-	-	-	-	-	-	-
MXST005	2m x 2m upholstered ceiling with ventilation/ Plafond en tissu avec aération 2m x 2m/ Stoffdecke inkl. Belüftung 2 mt x 2 mt	-	-	-	-	7911	-	-	-	-	-	-	-	-	-
MXSM006	2m x 2m solid ceiling without ventilation/ Plafond en panneau sans aération 2m x 2m/ Melamindecke ohne Belüftung 2 mt x 2 mt	-	-	-	-	2826	-	-	-	-	-	-	-	-	-
MXST006	2m x 2m upholstered ceiling without ventilation/ Plafond en tissu sans aération 2m x 2m/ Stoffdecke ohne Belüftung 2 mt x 2 mt	-	-	-	-	3879	-	-	-	-	-	-	-	-	-

PLEASE NOTE: at least one solid wall panel is mandatory
ATTENTION: Un côté plein toujours obligatoire
WARNUNG: Eine geschlossene Wandstrecke ist immer erforderlich

1 2 3 4 5

1	2	3	4	5
1962	1394	1594	2483	3201
1394	1594	2483	3201	2788
1594	2483	3201	2788	3507
2483	3201	2788	3507	-
3201	2788	3507	-	-
-	-	-	2827	-
-	-	-	2827	-
-	-	-	2827	-
-	-	-	2827	-
-	-	-	161	-
-	-	-	-	6859
-	-	-	-	7911
-	-	-	-	2826
-	-	-	-	3879

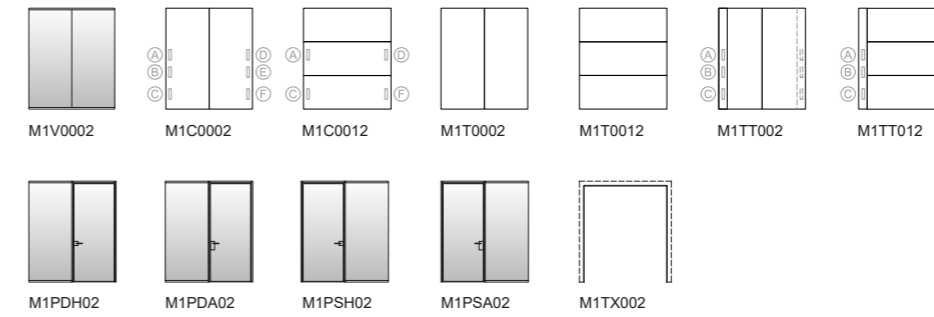

XChange

M1 - 2x2

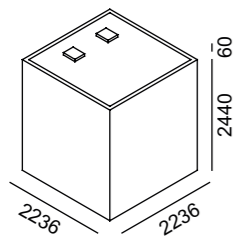
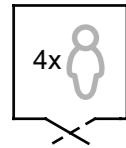

2x2 acoustic booth - middle door Cabine acoustique 2x2 - porte centrale Akustikkabine 2 mt x 2 mt - mittige Tür

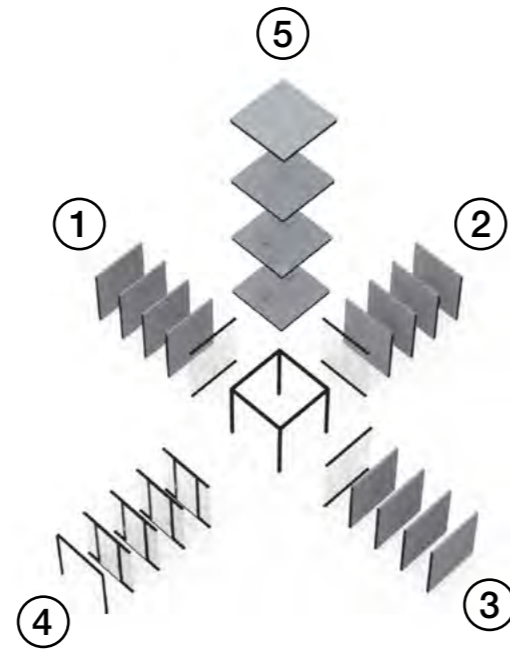

Cod. PBM11005

Code	Description	Configuration					Glass			Tracks		Lacquered solid wall		Wood veneer solid wall		Power modules			
		1	2	3	4	5	Frosted glass	Tracks in anthracite	Tracks in RAL of your choice	Lacquered solid wall (1 side)	Wood veneer solid wall (1 side)	EU (type F)	USA (type A)	S	L	S	L		
M1V0002	2m single glazed wall/ Section vitrée 2m simple vitrage/ Wandstrecke 2 mt mit einfachem Glas	1962	1962	1962	-	-	+542	+137	+403	-	-	-	-	-	-	-	-	-	
M1C0002	2m solid wall/ Section panneau 2m vertical/ Geschlossene Melaminwandstrecke 2 mt breit vertikal	1394	1394	1394	-	-	-	+102	+299	+537	+2195	+348	+400	+395	+447				
M1C0012	2m tiled solid wall/ Section panneau 2m horizontal/ Geschlossene Melaminwandstrecke 2 mt breit horizontal	1594	1594	1594	-	-	-	+102	+299	+549	+2207	+348	+400	+395	+447				
M1T0002	2m solid wall, inner upholstery/ Section tissu 2m vertical/ Stoffwandstrecke 2 mt vertikal	2483	2483	2483	-	-	-	+102	+299	-	-	-	-	-	-	-	-	-	
M1T0012	2m tiled solid wall, inner upholstery/ Section tissu 2m horizontal/ Stoffwandstrecke 2 mt horizontal	3201	3201	3201	-	-	-	+102	+299	-	-	-	-	-	-	-	-	-	
M1TT002	2m solid wall, switch post, inner upholstery/ Section tissu 2m vertical avec module technique/ Stoffwandstrecke 2 mt vertikal mit Technikmodul	2788	2788	2788	-	-	-	+102	+299	-	-	+369	+421	+416	+468				
M1TT012	2m tiled solid wall, switch post, inner upholstery/ Section tissu 2m horizontal avec module technique/ Stoffwandstrecke 2 mt horizontal mit Technikmodul	3507	3507	3507	-	-	-	+102	+299	-	-	+369	+421	+416	+468				
M1PDH03	2m wall with middle RH door, HCS handle/ Section porte tirant droite, poignée HCS, 2m centrale/ Wandstrecke 2 mt mit mittiger rechten Tür Griff HCS	-	-	-	2932	-	+481	+189	+444	-	-	-	-	-	-	-	-	-	
M1PDA03	2m wall with middle RH door, AGB handle/ Section porte tirant droite, poignée AGB, 2m centrale/ Wandstrecke 2 mt mit mittiger rechten Tür Griff AGB	-	-	-	2932	-	+481	+189	+444	-	-	-	-	-	-	-	-	-	
M1PSH03	2m wall with middle LH door, HCS handle/ Section porte tirant gauche, poignée HCS, 2m centrale/ Wandstrecke 2 mt mit mittiger linken Tür Griff HCS	-	-	-	2932	-	+481	+189	+444	-	-	-	-	-	-	-	-	-	
M1PSA03	2m wall with middle LH door, AGB handle/ Section porte tirant gauche, poignée AGB, 2m centrale/ Wandstrecke 2 mt mit mittiger linken Tür Griff AGB	-	-	-	2932	-	+481	+189	+444	-	-	-	-	-	-	-	-	-	
M1TX002	2m open side/ Section ouverte 2m/ Offene Wandstrecke 2 Mt breit	-	-	-	161	-	-	+123	+362	-	-	-	-	-	-	-	-	-	
MXSM005	2m x 2m solid ceiling with ventilation/ Plafond en panneau avec aération 2m x 2m/ Melamindecke inkl. Belüftung 2 mt x 2 mt	-	-	-	-	6859	-	-	-	-	-	-	-	-	-	-	-	-	
MXST005	2m x 2m upholstered ceiling with ventilation/ Plafond en tissu avec aération 2m x 2m/ Stoffdecke inkl. Belüftung 2 mt x 2 mt	-	-	-	-	7911	-	-	-	-	-	-	-	-	-	-	-	-	
MXSM006	2m x 2m solid ceiling without ventilation/ Plafond en panneau sans aération 2m x 2m/ Melamindecke ohne Belüftung 2 mt x 2 mt	-	-	-	-	2826	-	-	-	-	-	-	-	-	-	-	-	-	
MXST006	2m x 2m upholstered ceiling without ventilation/ Plafond en tissu sans aération 2m x 2m/ Stoffdecke ohne Belüftung 2 mt x 2 mt	-	-	-	-	3879	-	-	-	-	-	-	-	-	-	-	-	-	

PLEASE NOTE: at least one solid wall panel is mandatory
ATTENTION: Un côté plein toujours obligatoire
WARNUNG: Eine geschlossene Wandstrecke ist immer erforderlich

1 2 3 4 5

Frosted glass	Tracks in anthracite	Tracks in RAL of your choice	Lacquered solid wall (1 side)	Wood veneer solid wall (1 side)	Power modules / Multiprises / Mehrfachsteckdosen			
Verre dépoli	Profils gris ombre	Profils RAL au choix	Panneau RAL (1 côté)	Panneau mélamin (1 côté)	EU (type F)		USA (type A)	
Satinierteres Glas	Profil Dunkelgrau	Profil nach RAL Farbkarte	Panneel lackiert (einseitig)	Holzpaneel (einseitig)	S	L	S	L
+542	+137	+403	-	-	-	-	-	-
-	+102	+299	+537	+2195	+348	+400	+395	+447
-	+102	+299	+549	+2207	+348	+400	+395	+447
-	+102	+299	-	-	-	-	-	-
-	+102	+299	-	-	+369	+421	+416	+468
-	+102	+299	-	-	+369	+421	+416	+468
+481	+189	+444	-	-	-	-	-	-
+481	+189	+444	-	-	-	-	-	-
+481	+189	+444	-	-	-	-	-	-
-	+123	+362	-	-	-	-	-	-
-	-	-	-	-	-	-	-	-
-	-	-	-	-	-	-	-	-
-	-	-	-	-	-	-	-	-

3x2 acoustic booth - door on 3m wall
 Cabine acoustique 3x2 - porte côté 3 mètres
 Akustikkabine 3 mt x 2 mt - Tür auf 3 mt Seite

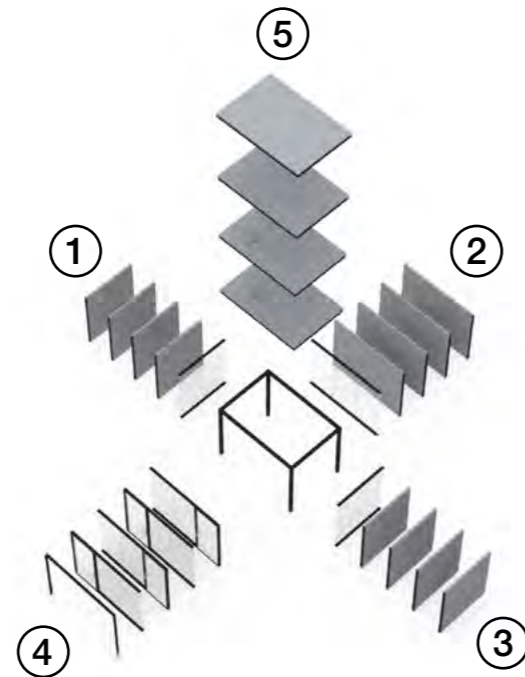
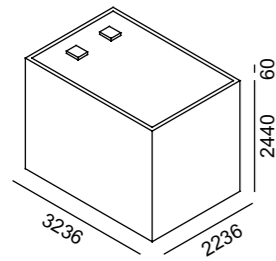
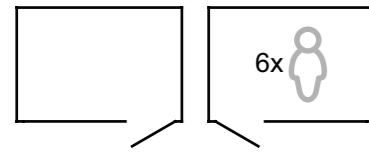

Cod. PBM11006

Code	Description	Wall Panels (1-5)					Glass Options			Tracks in anthracite		Tracks in RAL of your choice		Lacquered solid wall (1 side)		Wood veneer solid wall (1 side)		Power modules / Multiprises / Mehrfachsteckdosen			
		1	2	3	4	5	Frosted glass	Tracks in anthracite	Tracks in RAL of your choice	Lacquered solid wall (1 side)	Wood veneer solid wall (1 side)	EU (type F)	UK (type G)	S	L	S	L				
M1V0002	2m single glazed wall/ Section vitrée 2m simple vitrage/ Wandstrecke 2 mt mit einfachem Glas	1962	-	1962	-	-	+542	+137	+403	-	-	-	-	-	-	-	-	-	-	-	-
M1V0003	3m single glazed wall/ Section vitrée 3m simple vitrage/ Wandstrecke 3 mt mit einfachem Glas	-	2757	-	-	-	+813	+190	+561	-	-	-	-	-	-	-	-	-	-	-	-
M1C0002	2m solid wall/ Section panneau 2m vertical/ Geschlossene Melaminwandstrecke 2 mt breit vertikal	1394	-	1394	-	-	-	+102	+299	+537	+2195	+348	+400	+395	+447	-	-	-	-	-	-
M1C0012	2m tiled solid wall/ Section panneau 2m horizontal/ Geschlossene Melaminwandstrecke 2 mt breit horizontal	1594	-	1594	-	-	-	+102	+299	+549	+2207	+348	+400	+395	+447	-	-	-	-	-	-
M1T0002	2m solid wall, inner upholstery/ Section tissu 2m vertical/ Stoffwandstrecke 2 mt vertikal	2483	-	2483	-	-	-	+102	+299	-	-	-	-	-	-	-	-	-	-	-	-
M1T0012	2m tiled solid wall, inner upholstery/ Section tissu 2m horizontal/ Stoffwandstrecke 2 mt horizontal	3201	-	3201	-	-	-	+102	+299	-	-	-	-	-	-	-	-	-	-	-	-
M1TT002	2m solid wall, switch post, inner upholstery/ Section tissu 2m vertical avec module technique/ Stoffwandstrecke 2 mt vertikal mit Technikmodul	2788	-	2788	-	-	-	+102	+299	-	-	+369	+421	+416	+468	-	-	-	-	-	-
M1TT012	2m tiled solid wall, switch post, inner upholstery/ Section tissu 2m horizontal avec module technique/ Stoffwandstrecke 2 mt horizontal mit Technikmodul	3507	-	3507	-	-	-	+102	+299	-	-	+369	+421	+416	+468	-	-	-	-	-	-
M1C0003	3m solid wall/ Section panneau 3m vertical/ Geschlossene Melaminwandstrecke 3 mt breit vertikal	-	1788	-	-	-	-	+112	+331	+804	+3292	+348	+400	+395	+447	-	-	-	-	-	-
M1C0013	3m tiled solid wall/ Section panneau 3m horizontal/ Geschlossene Melaminwandstrecke 3 mt breit horizontal	-	1977	-	-	-	-	+112	+331	+823	+3311	+348	+400	+395	+447	-	-	-	-	-	-
M1T0003	3m solid wall, inner upholstery/ Section tissu 3m vertical/ Stoffwandstrecke 3 mt vertikal	-	3421	-	-	-	-	+112	+331	-	-	-	-	-	-	-	-	-	-	-	-
M1T0013	3m tiled solid wall, inner upholstery/ Section tissu 3m horizontal/ Stoffwandstrecke 3 mt horizontal	-	5468	-	-	-	-	+112	+331	-	-	-	-	-	-	-	-	-	-	-	-
M1TT003	3m solid wall, switch post, inner upholstery/ Section tissu 3m vertical avec module technique/ Stoffwandstrecke 3 mt vertikal mit Technikmodul	-	3726	-	-	-	-	+112	+331	-	-	+369	+421	+416	+468	-	-	-	-	-	-
M1TT013	3m tiled solid wall, switch post, inner upholstery/ Section tissu 3m horizontal avec module technique/ Stoffwandstrecke 3 mt horizontal mit Technikmodul	-	5773	-	-	-	-	+112	+331	-	-	+369	+421	+416	+468	-	-	-	-	-	-
M1PDH04	3m glazed RH door, HCS handle/ Section porte tirant droite, poignée HCS, 3m/ Wandstrecke 3 mt mit rechter Tür Griff HCS	-	-	-	3621	-	+752	+243	+602	-	-	-	-	-	-	-	-	-	-	-	-
M1PDA04	3m glazed RH door, AGB handle/ Section porte tirant droite, poignée AGB, 3m/ Wandstrecke 3 mt mit rechter Tür Griff AGB	-	-	-	3621	-	+752	+243	+602	-	-	-	-	-	-	-	-	-	-	-	-
M1PSH04	3m glazed LH door, HCS handle/ Section porte tirant gauche, poignée HCS, 3m/ Wandstrecke 3 mt mit linker Tür Griff HCS	-	-	-	3621	-	+752	+243	+602	-	-	-	-	-	-	-	-	-	-	-	-
M1PSA04	3m glazed LH door, AGB handle/ Section porte tirant gauche, poignée AGB, 3m/ Wandstrecke 3 mt mit linker Tür Griff AGB	-	-	-	3621	-	+752	+243	+602	-	-	-	-	-	-	-	-	-	-	-	-
M1TX003	3m open side/ Section ouverte 3m/ Offene Wandstrecke 3 Mt breit	-	-	-	164	-	-	+145	+425	-	-	-	-	-	-	-	-	-	-	-	-
MXSM007	3m x 2m solid ceiling with ventilation/ Plafond en panneau avec aération 3m x 2m/ Melamindecke inkl. Belüftung 3 mt x 2 mt	-	-	-	-	7887	-	-	-	-	-	-	-	-	-	-	-	-	-	-	-
MXST007	3m x 2m upholstered ceiling with ventilation/ Plafond en tissu avec aération 3m x 2m/ Stoffdecke inkl. Belüftung 3 mt x 2 mt	-	-	-	-	9466	-	-	-	-	-	-	-	-	-	-	-	-	-	-	-
MXSM008	3m x 2m solid ceiling without ventilation/ Plafond en panneau sans aération 3m x 2m/ Melamindecke ohne Belüftung 3 mt x 2 mt	-	-	-	-	3855	-	-	-	-	-	-	-	-	-	-	-	-	-	-	-
MXST008	3m x 2m upholstered ceiling without ventilation/ Plafond en tissu sans aération 3m x 2m/ Stoffdecke ohne Belüftung 3 mt x 2 mt	-	-	-	-	5433	-	-	-	-	-	-	-	-	-	-	-	-	-	-	-

3x2 acoustic booth - door on 3m wall
 Cabine acoustique 3x2 - porte côté 3 mètres
 Akustikkabine 3 mt x 2 mt - Tür auf 3 mt Seite

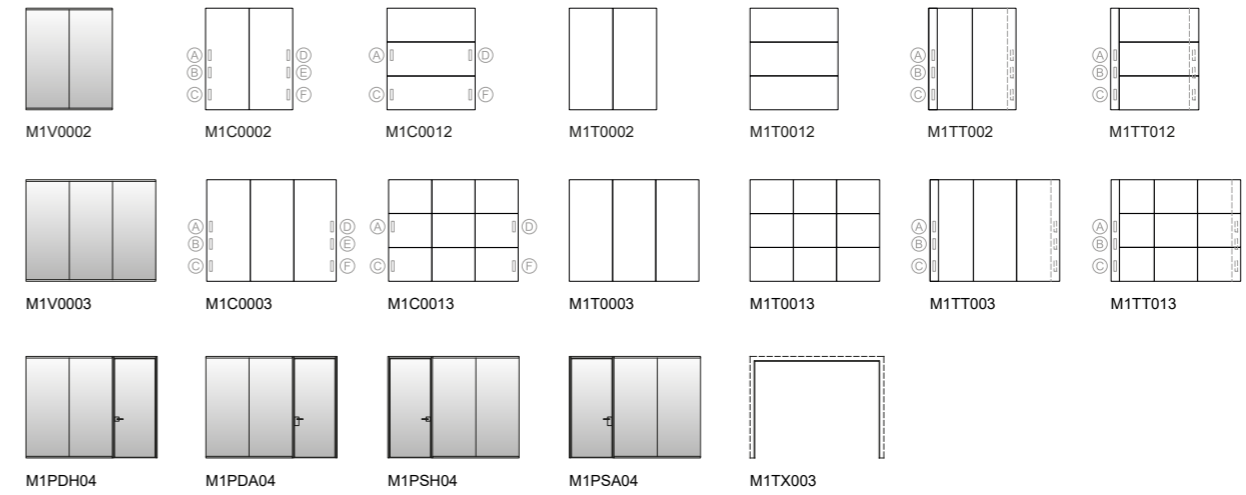

PLEASE NOTE: at least one solid wall panel is mandatory
 ATTENTION: Un côté plein toujours obligatoire
 WARNUNG: Eine geschlossene Wandstrecke ist immer erforderlich

1 2 3 4 5

Frosted glass		Tracks in anthracite		Tracks in RAL of your choice		Lacquered solid wall (1 side)		Wood veneer solid wall (1 side)		Power modules / Multiprises / Mehrfachsteckdosen					
Verre dépoli	Satiniertes Glas	Profilis gris ombre	Profilis Dunkelgrau	Profilis RAL au choix	Profilis nach RAL Farbkarte	Panneau RAL (1 côté)	Panneel lackiert (einseitig)	Panneau mélamin (1 côté)	Holzpaneel (einseitig)	EU (type F)	UK (type G)	S	L	S	L
+542	+137	+403	-	-	-	-	-	-	-	-	-	-	-	-	-
+813	+190	+561	-	-	-	-	-	-	-	-	-	-	-	-	-
-	+102	+299	+537	+2195	+348	+400	+395	+447	-	-	-	-	-	-	-
-	+102	+299	+549	+2207	+348	+400	+395	+447	-	-	-	-	-	-	-
-	+102	+299	-	-	-	-	-	-	-	-	-	-	-	-	-
-	+102	+299	-	-	+369	+421	+416	+468	-	-	-	-	-	-	-
-	+102	+299	-	-	+369	+421	+416	+468	-	-	-	-	-	-	-
-	+112	+331	+804	+3292	+348	+400	+395	+447	-	-	-	-	-	-	-
-	+112	+331	+823	+3311	+348	+400	+395	+447	-	-	-	-	-	-	-
-	+112	+331	-	-	-	-	-	-	-	-	-	-	-	-	-
-	+112	+331	-	-	+369	+421	+416	+468	-	-	-	-	-	-	-
-	+112	+331	-	-	+369	+421	+416	+468	-	-	-	-	-	-	-
-	+145	+425	-	-	-	-	-	-	-	-	-	-	-	-	-
-	-	-	-	-	-	-	-	-	-	-	-	-	-	-	-
-	-	-	-	-	-	-	-	-	-	-	-	-	-	-	-
-	-	-	-	-	-	-	-	-	-	-	-	-	-	-	-

3x2 acoustic booth - door in the middle of 3m wall
 Cabine acoustique 3x2 - porte côté 3 mètres centrale
 Akustikkabine 3 mt x 2 mt - mittige Tür auf 3 mt Seite

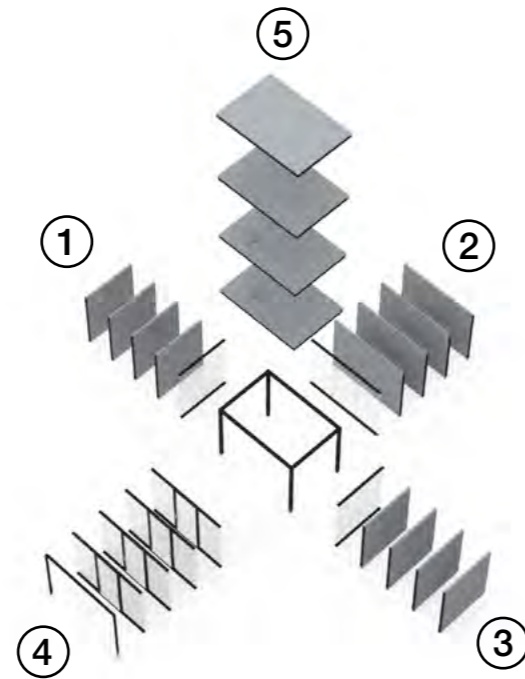
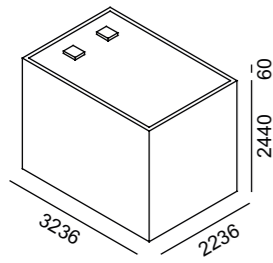
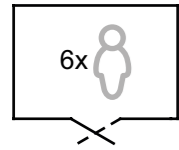

Cod. PBM11007

Code	Description	Wall Configuration					Glass & Tracks			Lacquered solid wall (1 side)		Wood veneer solid wall (1 side)		Power modules / Multiprises / Mehrfachsteckdosen			
		1	2	3	4	5	Frosted glass	Tracks in anthracite	Tracks in RAL of your choice	S	L	S	L	S	L	S	L
M1V0002	2m single glazed wall/ Section vitrée 2m simple vitrage/ Wandstrecke 2 mt mit einfachem Glas	1962	-	1962	-	-	+542	+137	+403	-	-	-	-	-	-	-	-
M1V0003	3m single glazed wall/ Section vitrée 3m simple vitrage/ Wandstrecke 3 mt mit einfachem Glas	-	2757	-	-	-	+813	+190	+561	-	-	-	-	-	-	-	-
M1C0002	2m solid wall/ Section panneau 2m vertical/ Geschlossene Melaminwandstrecke 2 mt breit vertikal	1394	-	1394	-	-	-	+102	+299	+537	+2195	+348	+400	+395	+447	-	-
M1C0012	2m tiled solid wall/ Section panneau 2m horizontal/ Geschlossene Melaminwandstrecke 2 mt breit horizontal	1594	-	1594	-	-	-	+102	+299	+549	+2207	+348	+400	+395	+447	-	-
M1T0002	2m solid wall, inner upholstery/ Section tissu 2m vertical/ Stoffwandstrecke 2 mt vertikal	2483	-	2483	-	-	-	+102	+299	-	-	-	-	-	-	-	-
M1T0012	2m tiled solid wall, inner upholstery/ Section tissu 2m horizontal/ Stoffwandstrecke 2 mt horizontal	3201	-	3201	-	-	-	+102	+299	-	-	-	-	-	-	-	-
M1TT002	2m solid wall, switch post, inner upholstery/ Section tissu 2m vertical avec module technique/ Stoffwandstrecke 2 mt vertikal mit Technikmodul	2788	-	2788	-	-	-	+102	+299	-	-	+369	+421	+416	+468	-	-
M1TT012	2m tiled solid wall, switch post, inner upholstery/ Section tissu 2m horizontal avec module technique/ Stoffwandstrecke 2 mt horizontal mit Technikmodul	3507	-	3507	-	-	-	+102	+299	-	-	+369	+421	+416	+468	-	-
M1C0003	3m solid wall/ Section panneau 3m vertical/ Geschlossene Melaminwandstrecke 3 mt breit vertikal	-	1788	-	-	-	-	+112	+331	+804	+3292	+348	+400	+395	+447	-	-
M1C0013	3m tiled solid wall/ Section panneau 3m horizontal/ Geschlossene Melaminwandstrecke 3 mt breit horizontal	-	1977	-	-	-	-	+112	+331	+823	+3311	+348	+400	+395	+447	-	-
M1T0003	3m solid wall, inner upholstery/ Section tissu 3m vertical/ Stoffwandstrecke 3 mt vertikal	-	3421	-	-	-	-	+112	+331	-	-	-	-	-	-	-	-
M1T0013	3m tiled solid wall, inner upholstery/ Section tissu 3m horizontal/ Stoffwandstrecke 3 mt horizontal	-	5468	-	-	-	-	+112	+331	-	-	-	-	-	-	-	-
M1TT003	3m solid wall, switch post, inner upholstery/ Section tissu 3m vertical avec module technique/ Stoffwandstrecke 3 mt vertikal mit Technikmodul	-	3726	-	-	-	-	+112	+331	-	-	+369	+421	+416	+468	-	-
M1TT013	3m tiled solid wall, switch post, inner upholstery/ Section tissu 3m horizontal avec module technique/ Stoffwandstrecke 3 mt horizontal mit Technikmodul	-	5773	-	-	-	-	+112	+331	-	-	+369	+421	+416	+468	-	-
M1PDH05	3m wall with middle RH door, HCS handle/ Section porte tirant droite, poignée HCS, 3m centrale/ Wandstrecke 3 mt mit mittiger rechten Tür Griff HCS	-	-	-	3705	-	+752	+243	+602	-	-	-	-	-	-	-	-
M1PDA05	3m wall with middle RH door, AGB handle/ Section porte tirant droite, poignée AGB, 3m centrale/ Wandstrecke 3 mt mit mittiger rechten Tür Griff AGB	-	-	-	3705	-	+752	+243	+602	-	-	-	-	-	-	-	-
M1PSH05	3m wall with middle LH door, HCS handle/ Section porte tirant gauche, poignée HCS, 3m centrale/ Wandstrecke 3 mt mit mittiger linken Tür Griff HCS	-	-	-	3705	-	+752	+243	+602	-	-	-	-	-	-	-	-
M1PSA05	3m wall with middle LH door, AGB handle/ Section porte tirant gauche, poignée AGB, 3m centrale/ Wandstrecke 3 mt mit mittiger linken Tür Griff AGB	-	-	-	3705	-	+752	+243	+602	-	-	-	-	-	-	-	-
M1TX003	3m open side/ Section ouverte 3m/ Offene Wandstrecke 3 Mt breit	-	-	-	164	-	-	+145	+425	-	-	-	-	-	-	-	-
MXSM007	3m x 2m solid ceiling with ventilation/ Plafond en panneau avec aération 3m x 2m/ Melamindecke inkl. Belüftung 3 mt x 2 mt	-	-	-	-	7887	-	-	-	-	-	-	-	-	-	-	-
MXST007	3m x 2m upholstered ceiling with ventilation/ Plafond en tissu avec aération 3m x 2m/ Stoffdecke inkl. Belüftung 3 mt x 2 mt	-	-	-	-	9466	-	-	-	-	-	-	-	-	-	-	-
MXSM008	3m x 2m solid ceiling without ventilation/ Plafond en panneau sans aération 3m x 2m/ Melamindecke ohne Belüftung 3 mt x 2 mt	-	-	-	-	3855	-	-	-	-	-	-	-	-	-	-	-
MXST008	3m x 2m upholstered ceiling without ventilation/ Plafond en tissu sans aération 3m x 2m/ Stoffdecke ohne Belüftung 3 mt x 2 mt	-	-	-	-	5433	-	-	-	-	-	-	-	-	-	-	-

3x2 acoustic booth - door in the middle of 3m wall
 Cabine acoustique 3x2 - porte côté 3 mètres centrale
 Akustikkabine 3 mt x 2 mt - mittige Tür auf 3 mt Seite

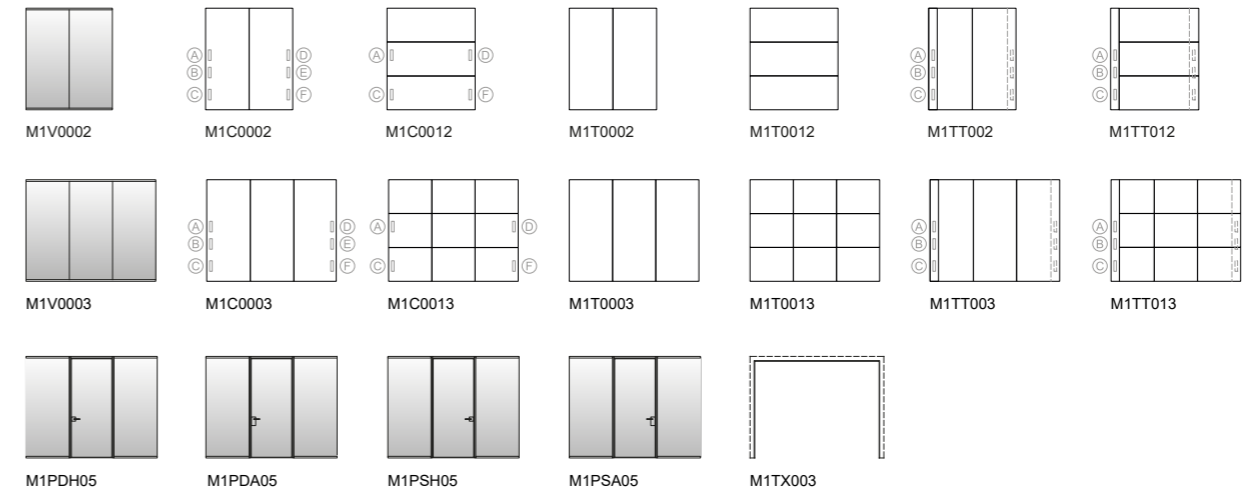

PLEASE NOTE: at least one solid wall panel is mandatory
 ATTENTION: Un côté plein toujours obligatoire
 WARNUNG: Eine geschlossene Wandstrecke ist immer erforderlich

1 2 3 4 5

Frosted glass	Tracks in anthracite	Tracks in RAL of your choice	Lacquered solid wall (1 side)	Wood veneer solid wall (1 side)	Power modules / Multiprises / Mehrfachsteckdosen			
					EU (type F)	UK (type G)	USA (type A)	
Verre dépoli	Profils gris ombre	Profilis RAL au choix	Panneau RAL (1 côté)	Panneau mélaminé (1 côté)	S	L	S	L
Satinierendes Glas	Profilis Dunkelgrau	Profile nach RAL Farbkarte	Panneel lackiert (einseitig)	Holzpaneel (einseitig)				

XChange

M1 - 2x3

2x3 acoustic booth - door on 2m wall
 Cabine acoustique 2x3 - porte côté 2 mètres
 Akustikkabine 3 mt x 2 mt - Tür auf 2 mt Seite

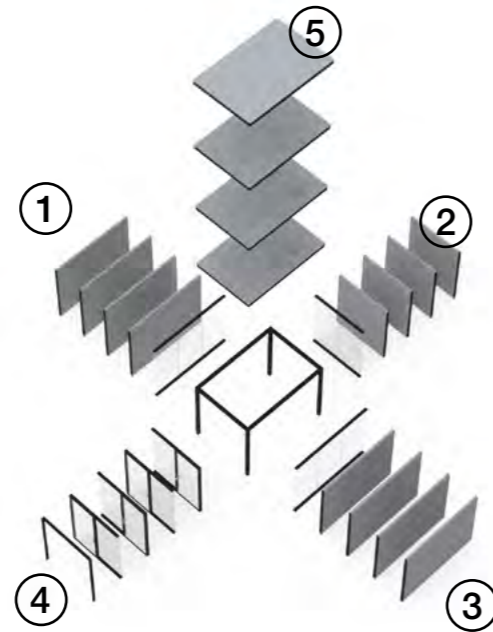
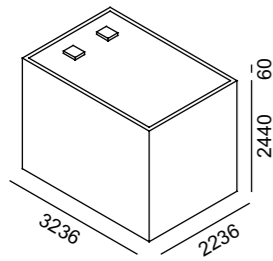
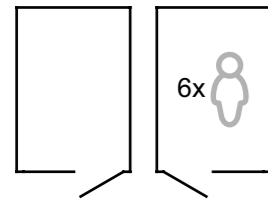

Cod. PBM11008

Cod.	Description	Wall Configuration					Glass Options			Tracks in RAL of your choice		Lacquered solid wall (1 side)		Wood veneer solid wall (1 side)		Power modules / Multiprises / Mehrfachsteckdosen			
		1	2	3	4	5	Frosted glass	Tracks in anthracite	Tracks in RAL of your choice	Lacquered solid wall (1 side)	Wood veneer solid wall (1 side)	EU (type F)	UK (type G)	S	L	S	L		
M1V0002	2m single glazed wall/ Section vitrée 2m simple vitrage/ Wandstrecke 2 mt mit einfachem Glas	-	1962	-	-	-	+542	+137	+403	-	-	-	-	-	-	-	-	-	
M1V0003	3m single glazed wall/ Section vitrée 3m simple vitrage/ Wandstrecke 3 mt mit einfachem Glas	2757	-	2757	-	-	+813	+190	+561	-	-	-	-	-	-	-	-	-	
M1C0002	2m solid wall/ Section panneau 2m vertical/ Geschlossene Melaminwandstrecke 2 mt breit vertikal	-	1394	-	-	-	-	+102	+299	+537	+2195	+348	+400	+395	+447	-	-	-	
M1C0012	2m tiled solid wall/ Section panneau 2m horizontal/ Geschlossene Melaminwandstrecke 2 mt breit horizontal	-	1594	-	-	-	-	+102	+299	+549	+2207	+348	+400	+395	+447	-	-	-	
M1T0002	2m solid wall, inner upholstery/ Section tissu 2m vertical/ Stoffwandstrecke 2 mt vertikal	-	2483	-	-	-	-	+102	+299	-	-	-	-	-	-	-	-	-	
M1T0012	2m tiled solid wall, inner upholstery/ Section tissu 2m horizontal/ Stoffwandstrecke 2 mt horizontal	-	3201	-	-	-	-	+102	+299	-	-	-	-	-	-	-	-	-	
M1TT002	2m solid wall, switch post, inner upholstery/ Section tissu 2m vertical avec module technique/ Stoffwandstrecke 2 mt vertikal mit Technikmodul	-	2788	-	-	-	-	+102	+299	-	-	+369	+421	+416	+468	-	-	-	
M1TT012	2m tiled solid wall, switch post, inner upholstery/ Section tissu 2m horizontal avec module technique/ Stoffwandstrecke 2 mt horizontal mit Technikmodul	-	3507	-	-	-	-	+102	+299	-	-	+369	+421	+416	+468	-	-	-	
M1C0003	3m solid wall/ Section panneau 3m vertical/ Geschlossene Melaminwandstrecke 3 mt breit vertikal	1788	-	1788	-	-	-	+112	+331	+804	+3292	+348	+400	+395	+447	-	-	-	
M1C0013	3m tiled solid wall/ Section panneau 3m horizontal/ Geschlossene Melaminwandstrecke 3 mt breit horizontal	1977	-	1977	-	-	-	+112	+331	+823	+3311	+348	+400	+395	+447	-	-	-	
M1T0003	3m solid wall, inner upholstery/ Section tissu 3m vertical/ Stoffwandstrecke 3 mt vertikal	3421	-	3421	-	-	-	+112	+331	-	-	-	-	-	-	-	-	-	
M1T0013	3m tiled solid wall, inner upholstery/ Section tissu 3m horizontal/ Stoffwandstrecke 3 mt horizontal	5468	-	5468	-	-	-	+112	+331	-	-	-	-	-	-	-	-	-	
M1TT003	3m solid wall, switch post, inner upholstery/ Section tissu 3m vertical avec module technique/ Stoffwandstrecke 3 mt vertikal mit Technikmodul	3726	-	3726	-	-	-	+112	+331	-	-	+369	+421	+416	+468	-	-	-	
M1TT013	3m tiled solid wall, switch post, inner upholstery/ Section tissu 3m horizontal avec module technique/ Stoffwandstrecke 3 mt horizontal mit Technikmodul	5773	-	5773	-	-	-	+112	+331	-	-	+369	+421	+416	+468	-	-	-	
M1PDH02	2m glazed RH door, HCS handle/ Section porte tirant droite, poignée HCS, 2m/ Wandstrecke 2 mt mit rechter Tür Griff HCS	-	-	-	2827	-	+481	+189	+444	-	-	-	-	-	-	-	-	-	
M1PDA02	2m glazed RH door, AGB handle/ Section porte tirant droite, poignée AGB, 2m/ Wandstrecke 2 mt mit rechter Tür Griff AGB	-	-	-	2827	-	+481	+189	+444	-	-	-	-	-	-	-	-	-	
M1PSH02	2m glazed LH door, HCS handle/ Section porte tirant gauche, poignée HCS, 2m/ Wandstrecke 2 mt mit linker Tür Griff HCS	-	-	-	2827	-	+481	+189	+444	-	-	-	-	-	-	-	-	-	
M1PSA02	2m glazed LH door, AGB handle/ Section porte tirant gauche, poignée AGB, 2m/ Wandstrecke 2 mt mit linker Tür Griff AGB	-	-	-	2827	-	+481	+189	+444	-	-	-	-	-	-	-	-	-	
M1TX002	2m open side/ Section ouverte 2m/ Offene Wandstrecke 2 Mt breit	-	-	-	161	-	-	+123	+362	-	-	-	-	-	-	-	-	-	
MXSM007	3m x 2m solid ceiling with ventilation/ Plafond en panneau avec aération 3m x 2m/ Melamindecke inkl. Belüftung 3 mt x 2 mt	-	-	-	-	7887	-	-	-	-	-	-	-	-	-	-	-	-	
MXST007	3m x 2m upholstered ceiling with ventilation/ Plafond en tissu avec aération 3m x 2m/ Stoffdecke inkl. Belüftung 3 mt x 2 mt	-	-	-	-	9466	-	-	-	-	-	-	-	-	-	-	-	-	
MXSM008	3m x 2m solid ceiling without ventilation/ Plafond en panneau sans aération 3m x 2m/ Melamindecke ohne Belüftung 3 mt x 2 mt	-	-	-	-	3855	-	-	-	-	-	-	-	-	-	-	-	-	
MXST008	3m x 2m upholstered ceiling without ventilation/ Plafond en tissu sans aération 3m x 2m/ Stoffdecke ohne Belüftung 3 mt x 2 mt	-	-	-	-	5433	-	-	-	-	-	-	-	-	-	-	-	-	

PLEASE NOTE: at least one solid wall panel is mandatory
 ATTENTION: Un côté plein toujours obligatoire
 WARNUNG: Eine geschlossene Wandstrecke ist immer erforderlich

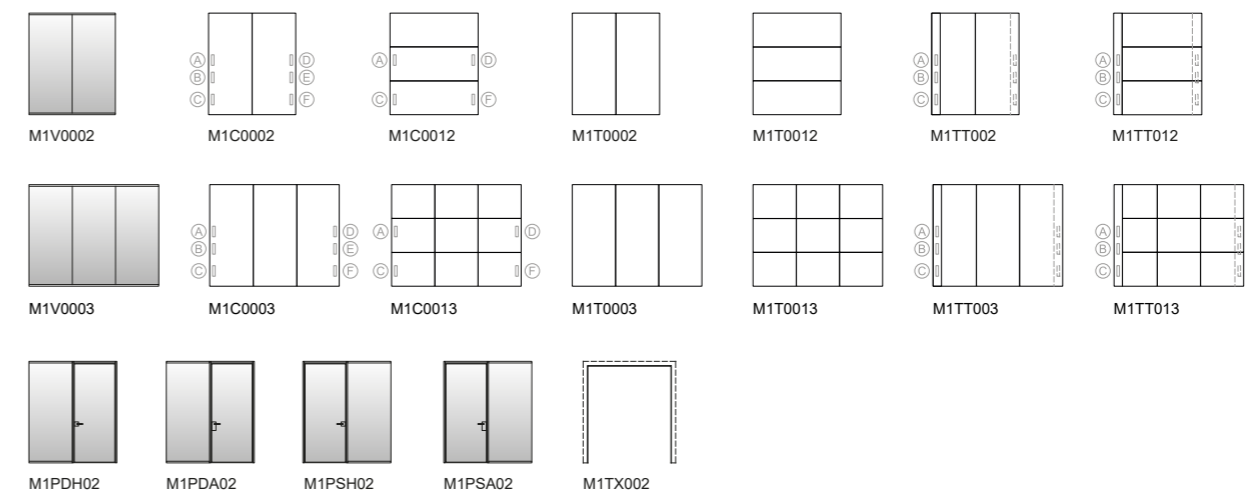

M1 - SINGLE GLASS

2x3 acoustic booth - door in the middle of 2m wall
 Cabine acoustique 2x3 - porte côté 2 mètres centrale
 Akustikkabine 3 mt x 2 mt - mittige Tür auf 2 mt Seite

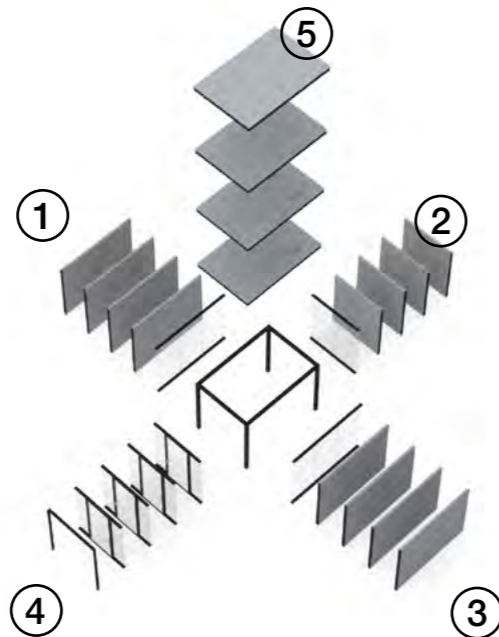
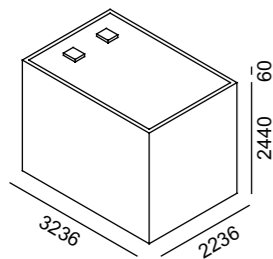
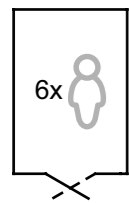

Cod. PBM11009

Code	Description	Wall Panels (1-5)					Glass & Tracks			Lacquered solid wall (1 side)		Wood veneer solid wall (1 side)		Power modules / Multiprisen / Mehrfachsteckdosen				
		1	2	3	4	5	Frosted glass Verre dépoli Satinieretes Glas	Tracks in anthracite Profils gris ombre Profile Dunkelgrau	Tracks in RAL of your choice Profils RAL au choix Profile nach RAL Farbkarte	S	L	S	L	EU (type F) S	EU (type F) L	UK (type G) USA (type A) S	UK (type G) USA (type A) L	
M1V0002	2m single glazed wall/ Section vitrée 2m simple vitrage/ Wandstrecke 2 mt mit einfachem Glas	-	1962	-	-	-	+542	+137	+403	-	-	-	-	-	-	-	-	-
M1V0003	3m single glazed wall/ Section vitrée 3m simple vitrage/ Wandstrecke 3 mt mit einfachem Glas	2757	-	2757	-	-	+813	+190	+561	-	-	-	-	-	-	-	-	-
M1C0002	2m solid wall/ Section panneau 2m vertical/ Geschlossene Melaminwandstrecke 2 mt breit vertikal	-	1394	-	-	-	-	+102	+299	+537	+2195	+348	+400	+395	+447	-	-	-
M1C0012	2m tiled solid wall/ Section panneau 2m horizontal/ Geschlossene Melaminwandstrecke 2 mt breit horizontal	-	1594	-	-	-	-	+102	+299	+549	+2207	+348	+400	+395	+447	-	-	-
M1T0002	2m solid wall, inner upholstery/ Section tissu 2m vertical/ Stoffwandstrecke 2 mt vertikal	-	2483	-	-	-	-	+102	+299	-	-	-	-	-	-	-	-	-
M1T0012	2m tiled solid wall, inner upholstery/ Section tissu 2m horizontal/ Stoffwandstrecke 2 mt horizontal	-	3201	-	-	-	-	+102	+299	-	-	-	-	-	-	-	-	-
M1TT002	2m solid wall, switch post, inner upholstery/ Section tissu 2m vertical avec module technique/ Stoffwandstrecke 2 mt vertikal mit Technikmodul	-	2788	-	-	-	-	+102	+299	-	-	+369	+421	+416	+468	-	-	-
M1TT012	2m tiled solid wall, switch post, inner upholstery/ Section tissu 2m horizontal avec module technique/ Stoffwandstrecke 2 mt horizontal mit Technikmodul	-	3507	-	-	-	-	+102	+299	-	-	+369	+421	+416	+468	-	-	-
M1C0003	3m solid wall/ Section panneau 3m vertical/ Geschlossene Melaminwandstrecke 3 mt breit vertikal	1788	-	1788	-	-	-	+112	+331	+804	+3292	+348	+400	+395	+447	-	-	-
M1C0013	3m tiled solid wall/ Section panneau 3m horizontal/ Geschlossene Melaminwandstrecke 3 mt breit horizontal	1977	-	1977	-	-	-	+112	+331	+823	+3311	+348	+400	+395	+447	-	-	-
M1T0003	3m solid wall, inner upholstery/ Section tissu 3m vertical/ Stoffwandstrecke 3 mt vertikal	3421	-	3421	-	-	-	+112	+331	-	-	-	-	-	-	-	-	-
M1T0013	3m tiled solid wall, inner upholstery/ Section tissu 3m horizontal/ Stoffwandstrecke 3 mt horizontal	5468	-	5468	-	-	-	+112	+331	-	-	-	-	-	-	-	-	-
M1TT003	3m solid wall, switch post, inner upholstery/ Section tissu 3m vertical avec module technique/ Stoffwandstrecke 3 mt vertikal mit Technikmodul	3726	-	3726	-	-	-	+112	+331	-	-	+369	+421	+416	+468	-	-	-
M1TT013	3m tiled solid wall, switch post, inner upholstery/ Section tissu 3m horizontal avec module technique/ Stoffwandstrecke 3 mt horizontal mit Technikmodul	5773	-	5773	-	-	-	+112	+331	-	-	+369	+421	+416	+468	-	-	-
M1PDH03	2m wall with middle RH door, HCS handle/ Section porte tirant droite, poignée HCS, 2m centrale/ Wandstrecke 2 mt mit mittiger rechten Tür Griff HCS	-	-	-	2932	-	+481	+189	+444	-	-	-	-	-	-	-	-	-
M1PDA03	2m wall with middle RH door, AGB handle/ Section porte tirant droite, poignée AGB, 2m centrale/ Wandstrecke 2 mt mit mittiger rechten Tür Griff AGB	-	-	-	2932	-	+481	+189	+444	-	-	-	-	-	-	-	-	-
M1PSH03	2m wall with middle LH door, HCS handle/ Section porte tirant gauche, poignée HCS, 2m centrale/ Wandstrecke 2 mt mit mittiger linken Tür Griff HCS	-	-	-	2932	-	+481	+189	+444	-	-	-	-	-	-	-	-	-
M1PSA03	2m wall with middle LH door, AGB handle/ Section porte tirant gauche, poignée AGB, 2m centrale/ Wandstrecke 2 mt mit mittiger linken Tür Griff AGB	-	-	-	2932	-	+481	+189	+444	-	-	-	-	-	-	-	-	-
M1TX002	2m open side/ Section ouverte 2m/ Offene Wandstrecke 2 Mt breit	-	-	-	161	-	-	+123	+362	-	-	-	-	-	-	-	-	-
MXSM007	3m x 2m solid ceiling with ventilation/ Plafond en panneau avec aération 3m x 2m/ Melamindecke inkl. Belüftung 3 mt x 2 mt	-	-	-	-	7887	-	-	-	-	-	-	-	-	-	-	-	-
MXST007	3m x 2m upholstered ceiling with ventilation/ Plafond en tissu avec aération 3m x 2m/ Stoffdecke inkl. Belüftung 3 mt x 2 mt	-	-	-	-	9466	-	-	-	-	-	-	-	-	-	-	-	-
MXSM008	3m x 2m solid ceiling without ventilation/ Plafond en panneau sans aération 3m x 2m/ Melamindecke ohne Belüftung 3 mt x 2 mt	-	-	-	-	3855	-	-	-	-	-	-	-	-	-	-	-	-
MXST008	3m x 2m upholstered ceiling without ventilation/ Plafond en tissu sans aération 3m x 2m/ Stoffdecke ohne Belüftung 3 mt x 2 mt	-	-	-	-	5433	-	-	-	-	-	-	-	-	-	-	-	-

2x3 acoustic booth - door in the middle of 2m wall
 Cabine acoustique 2x3 - porte côté 2 mètres centrale
 Akustikkabine 3 mt x 2 mt - mittige Tür auf 2 mt Seite

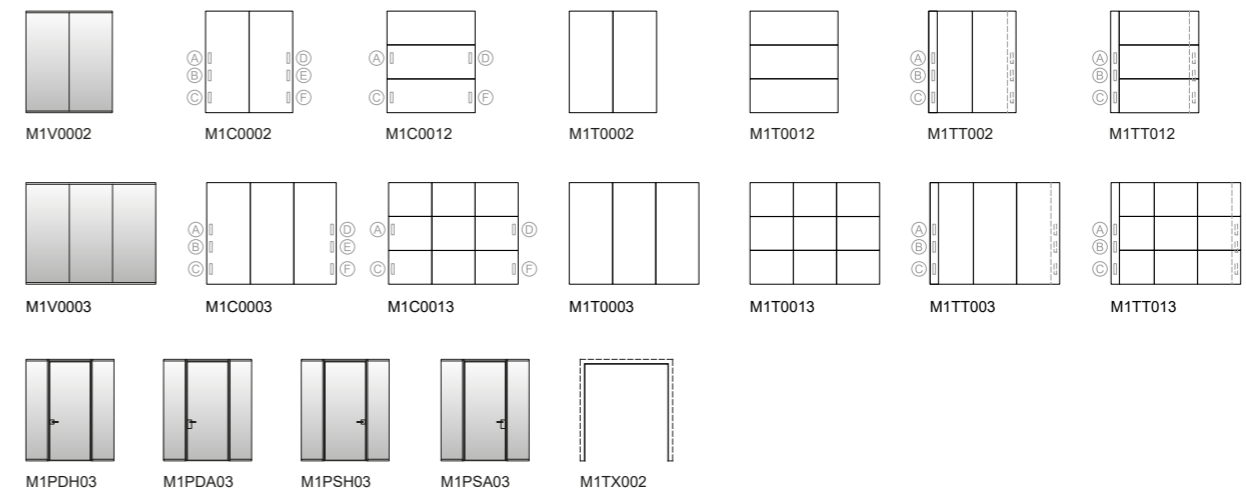

PLEASE NOTE: at least one solid wall panel is mandatory
 ATTENTION: Un côté plein toujours obligatoire
 WARNUNG: Eine geschlossene Wandstrecke ist immer erforderlich

1 2 3 4 5

Frosted glass Verre dépoli Satinieretes Glas	Tracks in anthracite Profils gris ombre Profile Dunkelgrau	Tracks in RAL of your choice Profils RAL au choix Profile nach RAL Farbkarte	Lacquered solid wall (1 side) Panneau RAL (1 côté) Panneel lackiert (einseitig)		Wood veneer solid wall (1 side) Panneau mélamin (1 côté) Holzpaneeel (einseitig)		Power modules / Multiprisen / Mehrfachsteckdosen											
			S	L	S	L	EU (type F) S	EU (type F) L	UK (type G) USA (type A) S	UK (type G) USA (type A) L								
+542	+137	+403	-	-	-	-	-	-	-	-	-	-	-	-	-	-	-	-
+813	+190	+561	-	-	-	-	-	-	-	-	-	-	-	-	-	-	-	-
-	+102	+299	+537	+2195	+348	+400	+395	+447	-	-	-	-	-	-	-	-	-	-
-	+102	+299	+549	+2207	+348	+400	+395	+447	-	-	-	-	-	-	-	-	-	-
-	+102	+299	-	-	-	-	-	-	-	-	-	-	-	-	-	-	-	-
-	+102	+299	-	-	+369	+421	+416	+468	-	-	-	-	-	-	-	-	-	-
-	+102	+299	-	-	+369	+421	+416	+468	-	-	-	-	-	-	-	-	-	-
-	+112	+331	+804	+3292	+348	+400	+395	+447	-	-	-	-	-	-	-	-	-	-
-	+112	+331	+823	+3311	+348	+400	+395	+447	-	-	-	-	-	-	-	-	-	-
-	+112	+331	-	-	-	-	-	-	-	-	-	-	-	-	-	-	-	-
-	+112	+331	-	-	+369	+421	+416	+468	-	-	-	-	-	-	-	-	-	-
-	+112	+331	-	-	+369	+421	+416	+468	-	-	-	-	-	-	-	-	-	-
+481	+189	+444	-	-	-	-	-	-	-	-	-	-	-	-	-	-	-	-
+481	+189	+444	-	-	-	-	-	-	-	-	-	-	-	-	-	-	-	-
+481	+189	+444	-	-	-	-	-	-	-	-	-	-	-	-	-	-	-	-
+481	+189	+444	-	-	-	-	-	-	-	-	-	-	-	-	-	-	-	-
-	+123	+362	-	-	-	-	-	-	-	-	-	-	-	-	-	-	-	-
-	-	-	-	-	-	-	-	-	-	-	-	-	-	-	-	-	-	-
-	-	-	-	-	-	-	-	-	-	-	-	-	-	-	-	-	-	-
-	-	-	-	-	-	-	-	-	-	-	-	-	-	-	-	-	-	-

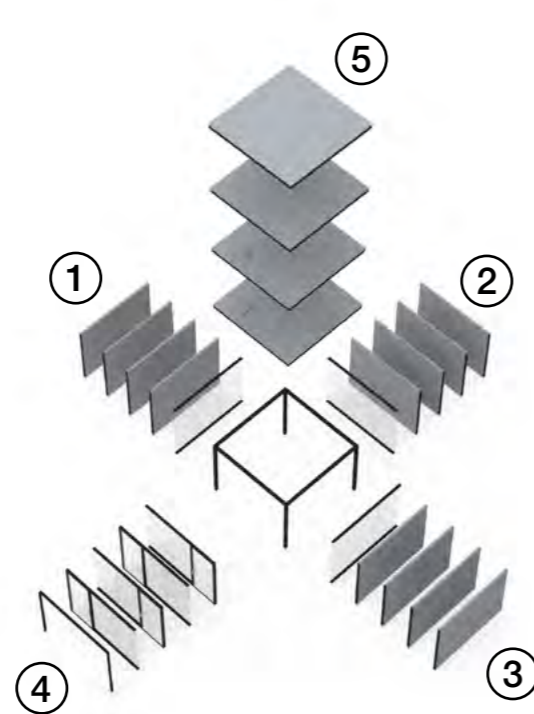
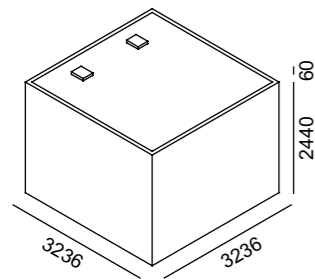
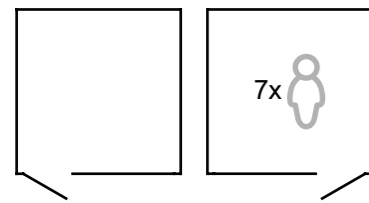

Cod. PBM11010

Code	Description
M1V0003	3m single glazed wall/ Section vitrée 3m simple vitrage/ Wandstrecke 3 mt mit einfachem Glas
M1C0003	3m solid wall/ Section panneau 3m vertical/ Geschlossene Melaminwandstrecke 3 mt breit vertikal
M1C0013	3m tiled solid wall/ Section panneau 3m horizontal/ Geschlossene Melaminwandstrecke 3 mt breit horizontal
M1T0003	3m solid wall, inner upholstery/ Section tissu 3m vertical/ Stoffwandstrecke 3 mt vertikal
M1T0013	3m tiled solid wall, inner upholstery/ Section tissu 3m horizontal/ Stoffwandstrecke 3 mt horizontal
M1TT003	3m solid wall, switch post, inner upholstery/ Section tissu 3m vertical avec module technique/ Stoffwandstrecke 3 mt vertikal mit Technikmodul
M1TT013	3m tiled solid wall, switch post, inner upholstery/ Section tissu 3m horizontal avec module technique/ Stoffwandstrecke 3 mt horizontal mit Technikmodul
M1PDH04	3m glazed RH door, HCS handle/ Section porte tirant droite, poignée HCS, 3m/ Wandstrecke 3 mt mit rechter Tür Griff HCS
M1PDA04	3m glazed RH door, AGB handle/ Section porte tirant droite, poignée AGB, 3m/ Wandstrecke 3 mt mit rechter Tür Griff AGB
M1PSH04	3m glazed LH door, HCS handle/ Section porte tirant gauche, poignée HCS, 3m/ Wandstrecke 3 mt mit linker Tür Griff HCS
M1PSA04	3m glazed LH door, AGB handle/ Section porte tirant gauche, poignée AGB, 3m/ Wandstrecke 3 mt mit linker Tür Griff AGB
M1TX003	3m open side/ Section ouverte 3m/ Offene Wandstrecke 3 Mt breit
MXSM009	3m x 3m solid ceiling with ventilation/ Plafond en panneau avec aération 3m x 3m/ Melamindecke inkl. Belüftung 3 mt x 3 mt
MXST009	3m x 3m upholstered ceiling with ventilation/ Plafond en tissu avec aération 3m x 3m/ Stoffdecke inkl. Belüftung 3 mt x 3 mt
MXSM010	3m x 3m solid ceiling without ventilation/ Plafond en panneau sans aération 3m x 3m/ Melamindecke ohne Belüftung 3 mt x 3 mt
MXST010	3m x 3m upholstered ceiling without ventilation/ Plafond en tissu sans aération 3m x 3m/ Stoffdecke ohne Belüftung 3 mt x 3 mt

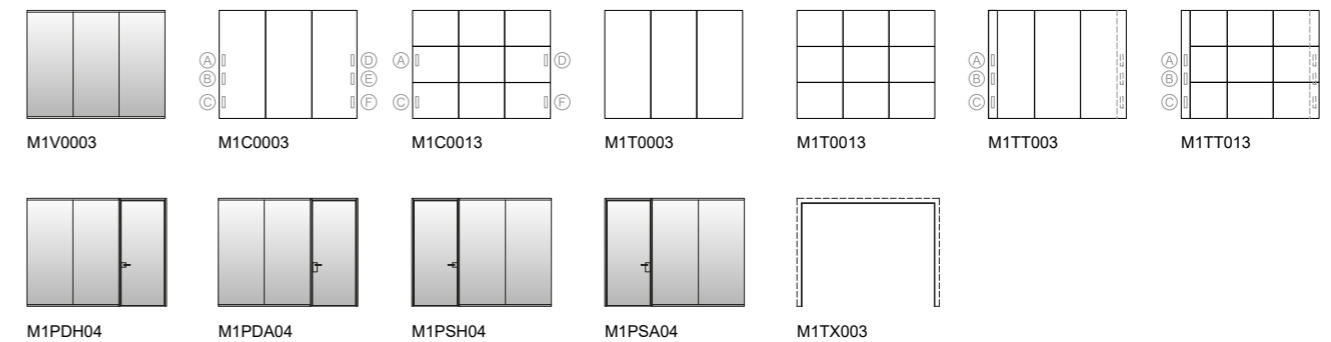

PLEASE NOTE: at least one solid wall panel is mandatory
ATTENTION: Un côté plein toujours obligatoire
WARNUNG: Eine geschlossene Wandstrecke ist immer erforderlich

1 2 3 4 5

	Frosted glass Verre dépoli Satiniertes Glas		Tracks in anthracite Profilis gris ombre Profilie Dunkelgrau		Tracks in RAL of your choice Profilis RAL au choix Profilie nach RAL Farbkarte		Lacquered solid wall (1 side) Panneau RAL (1 côté) Panneel lackiert (einseitig)		Wood veneer solid wall (1 side) Panneau mélamin (1 côté) Holzpaneel (einseitig)		Power modules / Multiprises / Mehrfachsteckdosen				
	S	L	S	L	S	L	S	L	S	L	S	L	S	L	
M1V0003	+813		+190		+561		-	-	-	-	-	-	-	-	-
M1C0003	-		+112		+331		+804	+3292	+348	+400	+395	+447			
M1C0013	-		+112		+331		+823	+3311	+348	+400	+395	+447			
M1T0003	-		+112		+331		-	-	-	-	-	-	-	-	
M1T0013	-		+112		+331		-	-	-	-	-	-	-	-	
M1TT003	-		+112		+331		-	-	+369	+421	+416	+468			
M1TT013	-		+112		+331		-	-	+369	+421	+416	+468			
M1PDH04	+752	+243	+602				-	-	-	-	-	-	-	-	
M1PDA04	+752	+243	+602				-	-	-	-	-	-	-	-	
M1PSH04	+752	+243	+602				-	-	-	-	-	-	-	-	
M1PSA04	+752	+243	+602				-	-	-	-	-	-	-	-	
M1TX003	-	+145	+425				-	-	-	-	-	-	-	-	
MXSM009	-	-	-		8902		-	-	-	-	-	-	-	-	
MXST009	-	-	-		10892		-	-	-	-	-	-	-	-	
MXSM010	-	-	-		4869		-	-	-	-	-	-	-	-	
MXST010	-	-	-		6859		-	-	-	-	-	-	-	-	

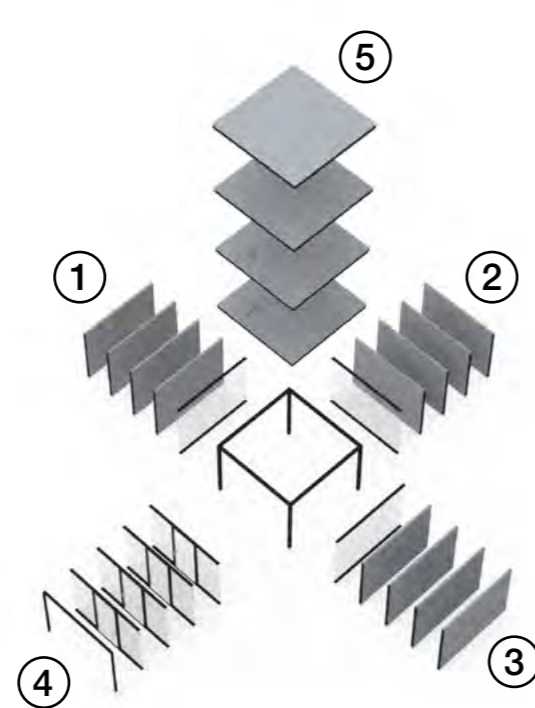
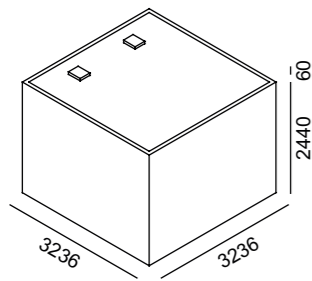
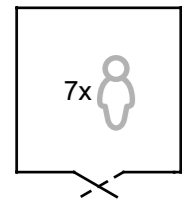

Cod. PBM11011

Cod.	Description	Booth Configuration					Frosted glass Verre dépoli Satiniertes Glas	Tracks in anthracite Profilis gris ombre Profilie Dunkelgrau	Tracks in RAL of your choice Profilis RAL au choix Profilie nach RAL Farbkarte	Lacquered solid wall (1 side) Panneau RAL (1 côté) Panneel lackert (einseitig)	Wood veneer solid wall (1 side) Panneau mélamin (1 côté) Holzpaneel (einseitig)	Power modules / Multiprises / Mehrfachsteckdosen			
		1	2	3	4	5						EU (type F) S L		UK (type G) USA (type A) S L	
M1V0003	3m single glazed wall/ Section vitrée 3m simple vitrage/ Wandstrecke 3 mt mit einfachem Glas	2757	2757	2757	-	-	+813	+190	+561	-	-	-	-	-	
M1C0003	3m solid wall/ Section panneau 3m vertical/ Geschlossene Melaminwandstrecke 3 mt breit vertikal	1788	1788	1788	-	-	-	+112	+331	+804	+3292	+348	+400	+395 +447	
M1C0013	3m tiled solid wall/ Section panneau 3m horizontal/ Geschlossene Melaminwandstrecke 3 mt breit horizontal	1977	1977	1977	-	-	-	+112	+331	+823	+3311	+348	+400	+395 +447	
M1T0003	3m solid wall, inner upholstery/ Section tissu 3m vertical/ Stoffwandstrecke 3 mt vertikal	3421	3421	3421	-	-	-	+112	+331	-	-	-	-	-	
M1T0013	3m tiled solid wall, inner upholstery/ Section tissu 3m horizontal/ Stoffwandstrecke 3 mt horizontal	5468	5468	5468	-	-	-	+112	+331	-	-	-	-	-	
M1TT003	3m solid wall, switch post, inner upholstery/ Section tissu 3m vertical avec module technique/ Stoffwandstrecke 3 mt vertikal mit Technikmodul	3726	3726	3726	-	-	-	+112	+331	-	-	+369	+421	+416 +468	
M1TT013	3m tiled solid wall, switch post, inner upholstery/ Section tissu 3m horizontal avec module technique/ Stoffwandstrecke 3 mt horizontal mit Technikmodul	5773	5773	5773	-	-	-	+112	+331	-	-	+369	+421	+416 +468	
M1PDH05	3m wall with middle RH door, HCS handle/ Section porte tirant droite, poignée HCS, 3m centrale/ Wandstrecke 3 mt mit mittiger rechten Tür Griff HCS	-	-	-	3705	-	+752	+243	+602	-	-	-	-	-	
M1PDA05	3m wall with middle RH door, AGB handle/ Section porte tirant droite, poignée AGB, 3m centrale/ Wandstrecke 3 mt mit mittiger rechten Tür Griff AGB	-	-	-	3705	-	+752	+243	+602	-	-	-	-	-	
M1PSH05	3m wall with middle LH door, HCS handle/ Section porte tirant gauche, poignée HCS, 3m centrale/ Wandstrecke 3 mt mit mittiger linken Tür Griff HCS	-	-	-	3705	-	+752	+243	+602	-	-	-	-	-	
M1PSA05	3m wall with middle LH door, AGB handle/ Section porte tirant gauche, poignée AGB, 3m centrale/ Wandstrecke 3 mt mit mittiger linken Tür Griff AGB	-	-	-	3705	-	+752	+243	+602	-	-	-	-	-	
M1TX003	3m open side/ Section ouverte 3m/ Offene Wandstrecke 3 Mt breit	-	-	-	164	-	-	+145	+425	-	-	-	-	-	
MXSM009	3m x 3m solid ceiling with ventilation/ Plafond en panneau avec aération 3m x 3m/ Melamindecke inkl. Belüftung 3 mt x 3 mt	-	-	-	-	8902	-	-	-	-	-	-	-	-	
MXST009	3m x 3m upholstered ceiling with ventilation/ Plafond en tissu avec aération 3m x 3m/ Stoffdecke inkl. Belüftung 3 mt x 3 mt	-	-	-	-	10892	-	-	-	-	-	-	-	-	
MXSM010	3m x 3m solid ceiling without ventilation/ Plafond en panneau sans aération 3m x 3m/ Melamindecke ohne Belüftung 3 mt x 3 mt	-	-	-	-	4869	-	-	-	-	-	-	-	-	
MXST010	3m x 3m upholstered ceiling without ventilation/ Plafond en tissu sans aération 3m x 3m/ Stoffdecke ohne Belüftung 3 mt x 3 mt	-	-	-	-	6859	-	-	-	-	-	-	-	-	

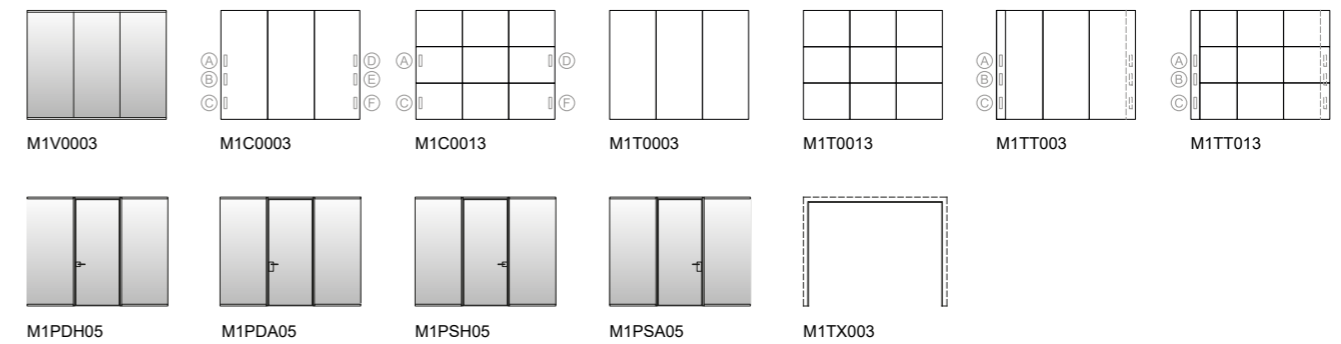

PLEASE NOTE: at least one solid wall panel is mandatory
ATTENTION: Un côté plein toujours obligatoire
WARNUNG: Eine geschlossene Wandstrecke ist immer erforderlich

1 2 3 4 5

Frosted glass Verre dépoli Satiniertes Glas	Tracks in anthracite Profilis gris ombre Profilie Dunkelgrau	Tracks in RAL of your choice Profilis RAL au choix Profilie nach RAL Farbkarte	Lacquered solid wall (1 side) Panneau RAL (1 côté) Panneel lackert (einseitig)	Wood veneer solid wall (1 side) Panneau mélamin (1 côté) Holzpaneel (einseitig)	Power modules / Multiprises / Mehrfachsteckdosen			
					EU (type F) S L		UK (type G) USA (type A) S L	
+813	+190	+561	-	-	-	-	-	-
-	+112	+331	+804	+3292	+348	+400	+395	+447
-	+112	+331	+823	+3311	+348	+400	+395	+447
-	+112	+331	-	-	-	-	-	-
-	+112	+331	-	-	-	-	-	-
-	+112	+331	-	-	+369	+421	+416	+468
-	+112	+331	-	-	+369	+421	+416	+468
+752	+243	+602	-	-	-	-	-	-
+752	+243	+602	-	-	-	-	-	-
+752	+243	+602	-	-	-	-	-	-
-	+145	+425	-	-	-	-	-	-
-	-	-	-	-	-	-	-	-
-	-	-	-	-	-	-	-	-
-	-	-	-	-	-	-	-	-

4x3 acoustic booth - door on 4m wall
 Cabine acoustique 4x3 - porte côté 4 mètres
 Akustikkabine 4 mt x 3 mt - Tür auf 4 mt Seite

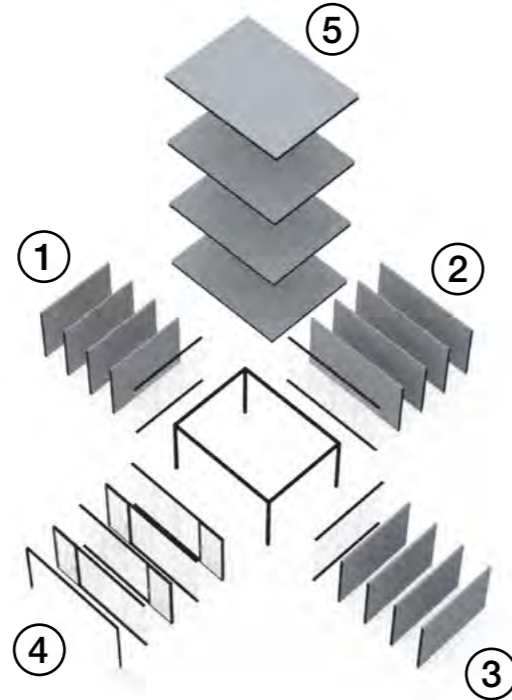
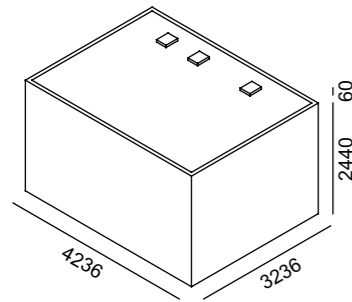
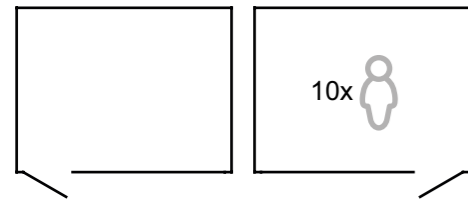

Cod. PBM11012

Code	Description
M1V0003	3m single glazed wall/ Section vitrée 3m simple vitrage/ Wandstrecke 3 mt mit einfachem Glas
M1V0004	4m single glazed wall/ Section vitrée 4m simple vitrage/ Wandstrecke 4 mt mit einfachem Glas
M1C0003	3m solid wall/ Section panneau 3m vertical/ Geschlossene Melaminwandstrecke 3 mt breit vertikal
M1C0013	3m tiled solid wall/ Section panneau 3m horizontal/ Geschlossene Melaminwandstrecke 3 mt breit horizontal
M1T0003	3m solid wall, inner upholstery/ Section tissu 3m vertical/ Stoffwandstrecke 3 mt vertikal
M1T0013	3m tiled solid wall, inner upholstery/ Section tissu 3m horizontal/ Stoffwandstrecke 3 mt horizontal
M1TT003	3m solid wall, switch post, inner upholstery/ Section tissu 3m vertical avec module technique/ Stoffwandstrecke 3 mt vertikal mit Technikmodul
M1TT013	3m tiled solid wall, switch post, inner upholstery/ Section tissu 3m horizontal avec module technique/ Stoffwandstrecke 3 mt horizontal mit Technikmodul
M1C0004	4m solid wall/ Section panneau 4m vertical/ Geschlossene Melaminwandstrecke 4 mt breit vertikal
M1C0014	4m tiled solid wall/ Section panneau 4m horizontal/ Geschlossene Melaminwandstrecke 4 mt breit horizontal
M1T0004	4m solid wall, inner upholstery/ Section tissu 4m vertical/ Stoffwandstrecke 4 mt vertikal
M1T0014	4m tiled solid wall, inner upholstery/ Section tissu 4m horizontal/ Stoffwandstrecke 4 mt horizontal
M1TT004	4m solid wall, switch post, inner upholstery/ Section tissu 4m vertical avec module technique/ Stoffwandstrecke 4 mt vertikal mit Technikmodul
M1TT014	4m tiled solid wall, switch post, inner upholstery/ Section tissu 4m horizontal avec module technique/ Stoffwandstrecke 4 mt horizontal mit Technikmodul
M1PDH06	4m glazed RH door, HCS handle/ Section porte tirant droite, poignée HCS, 4m/ Wandstrecke 4 mt mit rechter Tür Griff HCS
M1PDA06	4m glazed RH door, AGB handle/ Section porte tirant droite, poignée AGB, 4m/ Wandstrecke 4 mt mit rechter Tür Griff AGB
M1PSH06	4m glazed LH door, HCS handle/ Section porte tirant gauche, poignée HCS, 4m/ Wandstrecke 4 mt mit linker Tür Griff HCS
M1PSA06	4m glazed LH door, AGB handle/ Section porte tirant gauche, poignée AGB, 4m/ Wandstrecke 4 mt mit linker Tür Griff AGB
M1TX004	4m open side/ Section ouverte 4m/ Offene Wandstrecke 4 Mt breit
MXSM011	4m x 3m solid ceiling with ventilation/ Plafond en panneau avec aération 4m x 3m/ Melamindecke inkl. Belüftung 4 mt x 3 mt
MXST011	4m x 3m upholstered ceiling with ventilation/ Plafond en tissu avec aération 4m x 3m/ Stoffdecke inkl. Belüftung 4 mt x 3 mt
MXSM012	4m x 3m solid ceiling without ventilation/ Plafond en panneau sans aération 4m x 3m/ Melamindecke ohne Belüftung 4 mt x 3 mt
MXST012	4m x 3m upholstered ceiling without ventilation/ Plafond en tissu sans aération 4m x 3m/ Stoffdecke ohne Belüftung 4 mt x 3 mt

4x3 acoustic booth - door on 4m wall
 Cabine acoustique 4x3 - porte côté 4 mètres
 Akustikkabine 4 mt x 3 mt - Tür auf 4 mt Seite

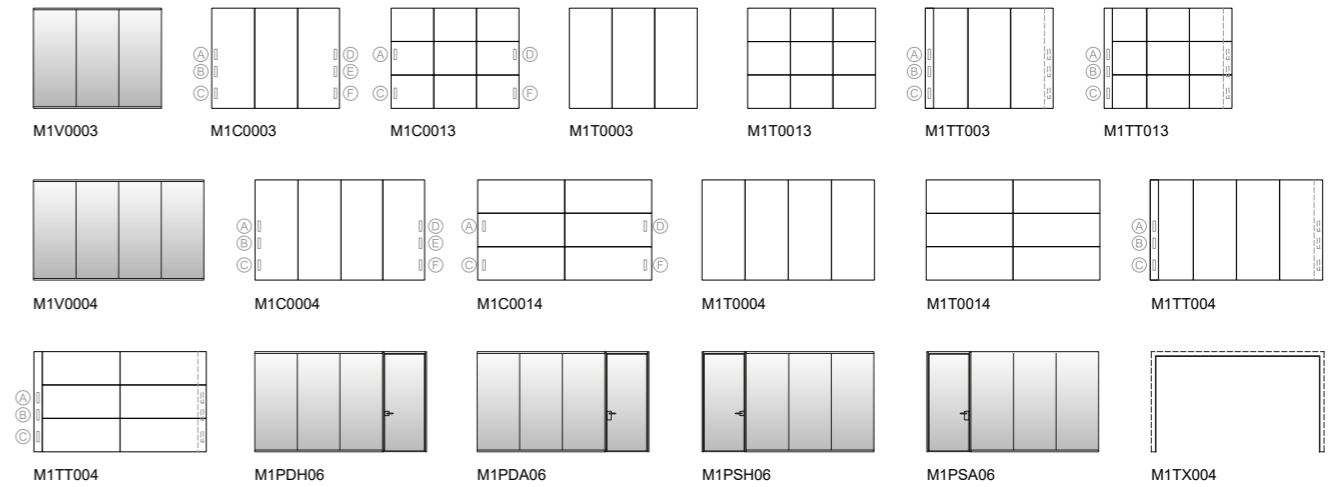

PLEASE NOTE: at least one solid wall panel is mandatory
 ATTENTION: Un côté plein toujours obligatoire
 WARNUNG: Eine geschlossene Wandstrecke ist immer erforderlich

	1 2 3 4 5					Frosted glass Verre dépoli Satiniertes Glas	Tracks in anthracite Profilis gris ombre Profilie Dunkelgrau	Tracks in RAL of your choice Profilis RAL au choix Profile nach RAL Farbkarte	Lacquered solid wall (1 side) Panneau RAL (1 côté) Panneel lackiert (einseitig)	Wood veneer solid wall (1 side) Panneau mélamin (1 côté) Holzpaneel (einseitig)	Power modules / Multiprises / Mehrfachsteckdosen				
	S	L	S	L	EU (type F) S						EU (type F) L	UK (type G) S	UK (type G) L		
M1V0003	2757	-	2757	-	-	+813	+190	+561	-	-	-	-	-	-	-
M1V0004	-	3552	-	-	-	+1084	+244	+718	-	-	-	-	-	-	-
M1C0003	1788	-	1788	-	-	-	+112	+331	+804	+3292	+348	+400	+395	+447	-
M1C0013	1977	-	1977	-	-	-	+112	+331	+823	+3311	+348	+400	+395	+447	-
M1T0003	3421	-	3421	-	-	-	+112	+331	-	-	-	-	-	-	-
M1T0013	5468	-	5468	-	-	-	+112	+331	-	-	-	-	-	-	-
M1TT003	3726	-	3726	-	-	-	+112	+331	-	-	+369	+421	+416	+468	-
M1TT013	5773	-	5773	-	-	-	+112	+331	-	-	+369	+421	+416	+468	-
M1C0004	-	2182	-	-	-	-	+123	+362	+1073	+4389	+348	+400	+395	+447	-
M1C0014	-	2581	-	-	-	-	+123	+362	+1098	+4414	+348	+400	+395	+447	-
M1T0004	-	4360	-	-	-	-	+123	+362	-	-	-	-	-	-	-
M1T0014	-	5797	-	-	-	-	+123	+362	-	-	-	-	-	-	-
M1TT004	-	4664	-	-	-	-	+123	+362	-	-	+369	+421	+416	+468	-
M1TT014	-	6102	-	-	-	-	+123	+362	-	-	+369	+421	+416	+468	-
M1PDH06	-	-	-	4416	-	+1023	+296	+759	-	-	-	-	-	-	-
M1PDA06	-	-	-	4416	-	+1023	+296	+759	-	-	-	-	-	-	-
M1PSH06	-	-	-	4416	-	+1023	+296	+759	-	-	-	-	-	-	-
M1PSA06	-	-	-	4416	-	+1023	+296	+759	-	-	-	-	-	-	-
M1TX004	-	-	-	167	-	-	+166	+488	-	-	-	-	-	-	-
MXSM011	-	-	-	-	11721	-	-	-	-	-	-	-	-	-	-
MXST011	-	-	-	-	14373	-	-	-	-	-	-	-	-	-	-
MXSM012	-	-	-	-	5931	-	-	-	-	-	-	-	-	-	-
MXST012	-	-	-	-	8584	-	-	-	-	-	-	-	-	-	-

4x3 acoustic booth - door in the middle of 4m wall
 Cabine acoustique 4x3 - porte côté 4 mètres centrale
 Akustikkabine 4 mt x 3 mt - mittige Tür auf 4 mt Seite

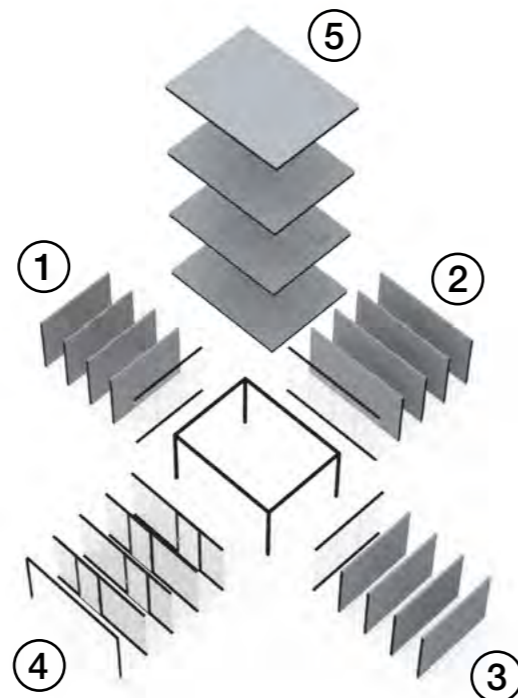
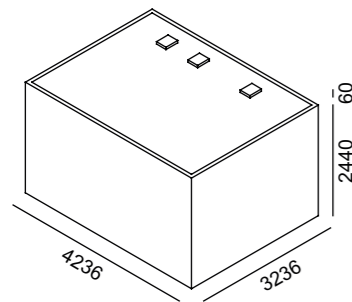
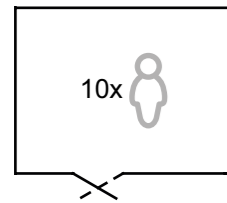

Cod. PBM11013

Cod.	Description	Configuration					Glass & Profiles			Lacquered solid wall (1 side)		Wood veneer solid wall (1 side)		Power modules / Multiprises / Mehrfachsteckdosen			
		1	2	3	4	5	Frosted glass	Tracks in anthracite	Tracks in RAL of your choice	Panel	Panel	EU (type F)	UK (type G)	USA (type A)			
		S	L	S	L	S	L	S	L	S	L	S	L	S	L		
M1V0003	3m single glazed wall/ Section vitrée 3m simple vitrage/ Wandstrecke 3 mt mit einfachem Glas	2757	-	2757	-	-	+813	+190	+561	-	-	-	-	-	-		
M1V0004	4m single glazed wall/ Section vitrée 4m simple vitrage/ Wandstrecke 4 mt mit einfachem Glas	-	3552	-	-	-	+1084	+244	+718	-	-	-	-	-	-		
M1C0003	3m solid wall/ Section panneau 3m vertical/ Geschlossene Melaminwandstrecke 3 mt breit vertikal	1788	-	1788	-	-	-	+112	+331	+804	+3292	+348	+400	+395	+447		
M1C0013	3m tiled solid wall/ Section panneau 3m horizontal/ Geschlossene Melaminwandstrecke 3 mt breit horizontal	1977	-	1977	-	-	-	+112	+331	+823	+3311	+348	+400	+395	+447		
M1T0003	3m solid wall, inner upholstery/ Section tissu 3m vertical/ Stoffwandstrecke 3 mt vertikal	3421	-	3421	-	-	-	+112	+331	-	-	-	-	-	-		
M1T0013	3m tiled solid wall, inner upholstery/ Section tissu 3m horizontal/ Stoffwandstrecke 3 mt horizontal	5468	-	5468	-	-	-	+112	+331	-	-	-	-	-	-		
M1TT003	3m solid wall, switch post, inner upholstery/ Section tissu 3m vertical avec module technique/ Stoffwandstrecke 3 mt vertikal mit Technikmodul	3726	-	3726	-	-	-	+112	+331	-	-	+369	+421	+416	+468		
M1TT013	3m tiled solid wall, switch post, inner upholstery/ Section tissu 3m horizontal avec module technique/ Stoffwandstrecke 3 mt horizontal mit Technikmodul	5773	-	5773	-	-	-	+112	+331	-	-	+369	+421	+416	+468		
M1C0004	4m solid wall/ Section panneau 4m vertical/ Geschlossene Melaminwandstrecke 4 mt breit vertikal	-	2182	-	-	-	-	+123	+362	+1073	+4389	+348	+400	+395	+447		
M1C0014	4m tiled solid wall/ Section panneau 4m horizontal/ Geschlossene Melaminwandstrecke 4 mt breit horizontal	-	2581	-	-	-	-	+123	+362	+1098	+4414	+348	+400	+395	+447		
M1T0004	4m solid wall, inner upholstery/ Section tissu 4m vertical/ Stoffwandstrecke 4 mt vertikal	-	4360	-	-	-	-	+123	+362	-	-	-	-	-	-		
M1T0014	4m tiled solid wall, inner upholstery/ Section tissu 4m horizontal/ Stoffwandstrecke 4 mt horizontal	-	5797	-	-	-	-	+123	+362	-	-	-	-	-	-		
M1TT004	4m solid wall, switch post, inner upholstery/ Section tissu 4m vertical avec module technique/ Stoffwandstrecke 4 mt vertikal mit Technikmodul	-	4664	-	-	-	-	+123	+362	-	-	+369	+421	+416	+468		
M1TT014	4m tiled solid wall, switch post, inner upholstery/ Section tissu 4m horizontal avec module technique/ Stoffwandstrecke 4 mt horizontal mit Technikmodul	-	6102	-	-	-	-	+123	+362	-	-	+369	+421	+416	+468		
M1PDH07	4m wall with middle RH door, HCS handle/ Section porte tirant droite, poignée HCS, 4m centrale/ Wandstrecke 4 mt mit mittiger rechten Tür Griff HCS	-	-	-	4508	-	+1023	+296	+759	-	-	-	-	-	-		
M1PDA07	4m wall with middle RH door, AGB handle/ Section porte tirant droite, poignée AGB, 4m centrale/ Wandstrecke 4 mt mit mittiger rechten Tür Griff AGB	-	-	-	4508	-	+1023	+296	+759	-	-	-	-	-	-		
M1PSH07	4m wall with middle LH door, HCS handle/ Section porte tirant gauche, poignée HCS, 4m centrale/ Wandstrecke 4 mt mit mittiger linken Tür Griff HCS	-	-	-	4508	-	+1023	+296	+759	-	-	-	-	-	-		
M1PSA07	4m wall with middle LH door, AGB handle/ Section porte tirant gauche, poignée AGB, 4m centrale/ Wandstrecke 4 mt mit mittiger linken Tür Griff AGB	-	-	-	4552	-	+1023	+296	+759	-	-	-	-	-	-		
M1TX004	4m open side/ Section ouverte 4m/ Offene Wandstrecke 4 Mt breit	-	-	-	167	-	-	+166	+488	-	-	-	-	-	-		
MXSM011	4m x 3m solid ceiling with ventilation/ Plafond en panneau avec aération 4m x 3m/ Melamindecke inkl. Belüftung 4 mt x 3 mt	-	-	-	-	11721	-	-	-	-	-	-	-	-	-		
MXST011	4m x 3m upholstered ceiling with ventilation/ Plafond en tissu avec aération 4m x 3m/ Stoffdecke inkl. Belüftung 4 mt x 3 mt	-	-	-	-	14373	-	-	-	-	-	-	-	-	-		
MXSM012	4m x 3m solid ceiling without ventilation/ Plafond en panneau sans aération 4m x 3m/ Melamindecke ohne Belüftung 4 mt x 3 mt	-	-	-	-	5931	-	-	-	-	-	-	-	-	-		
MXST012	4m x 3m upholstered ceiling without ventilation/ Plafond en tissu sans aération 4m x 3m/ Stoffdecke ohne Belüftung 4 mt x 3 mt	-	-	-	-	8584	-	-	-	-	-	-	-	-	-		

PLEASE NOTE: at least one solid wall panel is mandatory
 ATTENTION: Un côté plein toujours obligatoire
 WARNUNG: Eine geschlossene Wandstrecke ist immer erforderlich

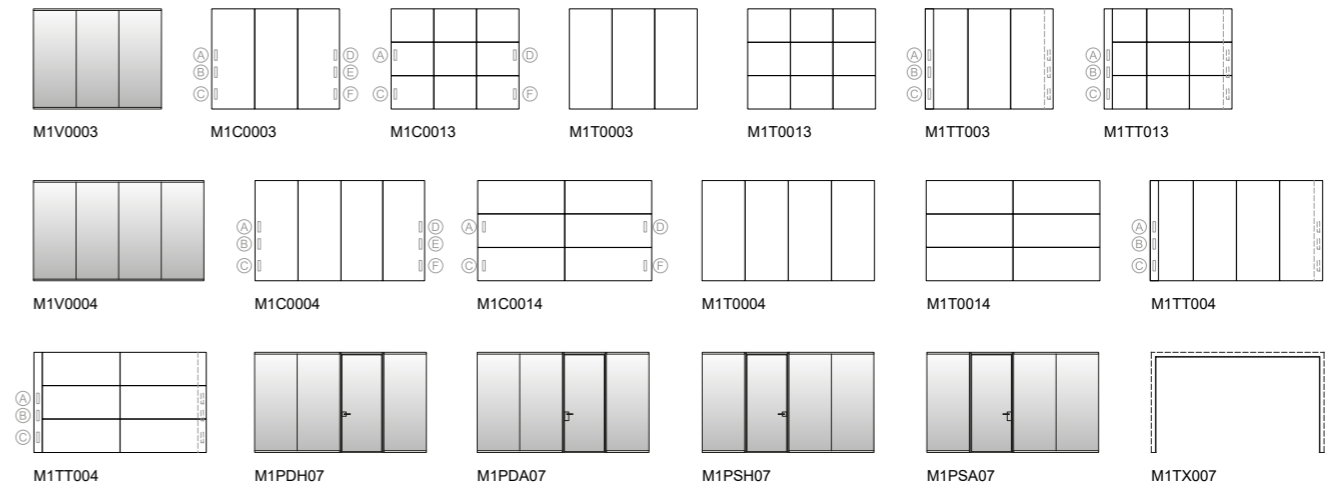

4x3 acoustic booth - door in the middle of 4m wall
 Cabine acoustique 4x3 - porte côté 4 mètres centrale
 Akustikkabine 4 mt x 3 mt - mittige Tür auf 4 mt Seite

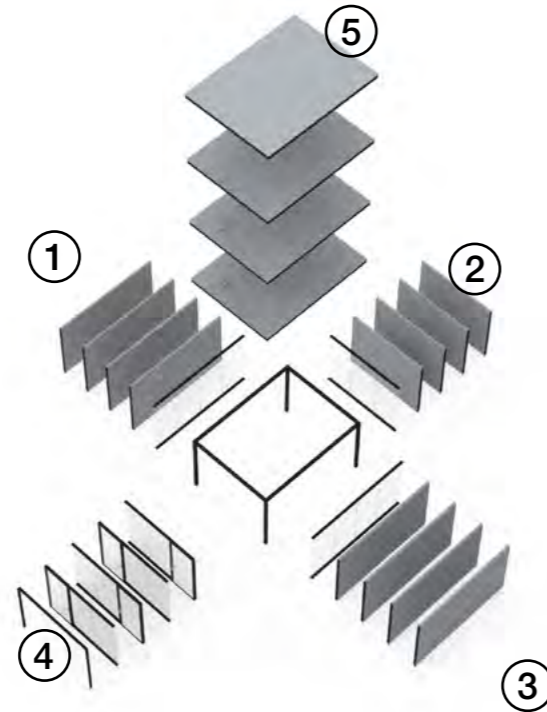
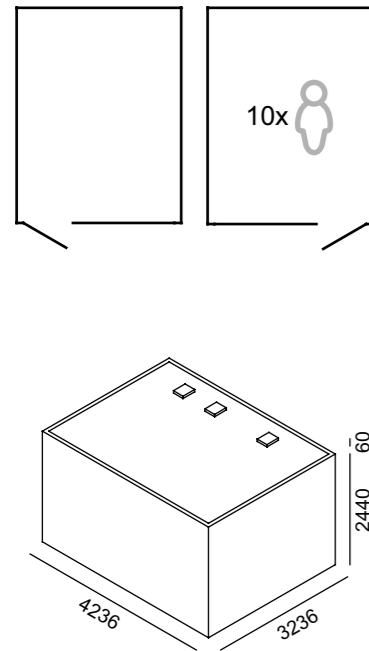

Cod. PBM11014

Code	Description	Wall Configuration					Glass Options			Lacquered Solid Wall		Wood Veneer Solid Wall		Power Modules			
		1	2	3	4	5	Frosted glass	Tracks in anthracite	Tracks in RAL of your choice	Lacquered solid wall (1 side)	Wood veneer solid wall (1 side)	EU (type F)	UK (type G)	S	L	S	L
M1V0003	3m single glazed wall/ Section vitrée 3m simple vitrage/ Wandstrecke 3 mt mit einfachem Glas	-	2757	-	-	-	+813	+190	+561	-	-	-	-	-	-	-	-
M1V0004	4m single glazed wall/ Section vitrée 4m simple vitrage/ Wandstrecke 4 mt mit einfachem Glas	3552	-	3552	-	-	+1084	+244	+718	-	-	-	-	-	-	-	-
M1C0003	3m solid wall/ Section panneau 3m vertical/ Geschlossene Melaminwandstrecke 3 mt breit vertikal	-	1788	-	-	-	-	+112	+331	+804	+3292	+348	+400	+395	+447	-	-
M1C0013	3m tiled solid wall/ Section panneau 3m horizontal/ Geschlossene Melaminwandstrecke 3 mt breit horizontal	-	1977	-	-	-	-	+112	+331	+823	+3311	+348	+400	+395	+447	-	-
M1T0003	3m solid wall, inner upholstery/ Section tissu 3m vertical/ Stoffwandstrecke 3 mt vertikal	-	3421	-	-	-	-	+112	+331	-	-	-	-	-	-	-	-
M1T0013	3m tiled solid wall, inner upholstery/ Section tissu 3m horizontal/ Stoffwandstrecke 3 mt horizontal	-	5468	-	-	-	-	+112	+331	-	-	-	-	-	-	-	-
M1TT003	3m solid wall, switch post, inner upholstery/ Section tissu 3m vertical avec module technique/ Stoffwandstrecke 3 mt vertikal mit Technikmodul	-	3726	-	-	-	-	+112	+331	-	-	+369	+421	+416	+468	-	-
M1TT013	3m tiled solid wall, switch post, inner upholstery/ Section tissu 3m horizontal avec module technique/ Stoffwandstrecke 3 mt horizontal mit Technikmodul	-	5773	-	-	-	-	+112	+331	-	-	+369	+421	+416	+468	-	-
M1C0004	4m solid wall/ Section panneau 4m vertical/ Geschlossene Melaminwandstrecke 4 mt breit vertikal	2182	-	2182	-	-	-	+123	+362	+1073	+4389	+348	+400	+395	+447	-	-
M1C0014	4m tiled solid wall/ Section panneau 4m horizontal/ Geschlossene Melaminwandstrecke 4 mt breit horizontal	2581	-	2581	-	-	-	+123	+362	+1098	+4414	+348	+400	+395	+447	-	-
M1T0004	4m solid wall, inner upholstery/ Section tissu 4m vertical/ Stoffwandstrecke 4 mt vertikal	4360	-	4360	-	-	-	+123	+362	-	-	-	-	-	-	-	-
M1T0014	4m tiled solid wall, inner upholstery/ Section tissu 4m horizontal/ Stoffwandstrecke 4 mt horizontal	5797	-	5797	-	-	-	+123	+362	-	-	-	-	-	-	-	-
M1TT004	4m solid wall, switch post, inner upholstery/ Section tissu 4m vertical avec module technique/ Stoffwandstrecke 4 mt vertikal mit Technikmodul	4664	-	4664	-	-	-	+123	+362	-	-	+369	+421	+416	+468	-	-
M1TT014	4m tiled solid wall, switch post, inner upholstery/ Section tissu 4m horizontal avec module technique/ Stoffwandstrecke 4 mt horizontal mit Technikmodul	6102	-	6102	-	-	-	+123	+362	-	-	+369	+421	+416	+468	-	-
M1PDH04	3m glazed RH door, HCS handle/ Section porte tirant droite, poignée HCS, 3m/ Wandstrecke 3 mt mit rechter Tür Griff HCS	-	-	-	3621	-	+752	+243	+602	-	-	-	-	-	-	-	-
M1PDA04	3m glazed RH door, AGB handle/ Section porte tirant droite, poignée AGB, 3m/ Wandstrecke 3 mt mit rechter Tür Griff AGB	-	-	-	3621	-	+752	+243	+602	-	-	-	-	-	-	-	-
M1PSH04	3m glazed LH door, HCS handle/ Section porte tirant gauche, poignée HCS, 3m/ Wandstrecke 3 mt mit linker Tür Griff HCS	-	-	-	3621	-	+752	+243	+602	-	-	-	-	-	-	-	-
M1PSA04	3m glazed LH door, AGB handle/ Section porte tirant gauche, poignée AGB, 3m/ Wandstrecke 3 mt mit linker Tür Griff AGB	-	-	-	3621	-	+752	+243	+602	-	-	-	-	-	-	-	-
M1TX003	3m open side/ Section ouverte 3m/ Offene Wandstrecke 3 Mt breit	-	-	-	164	-	-	+145	+425	-	-	-	-	-	-	-	-
MXSM011	4m x 3m solid ceiling with ventilation/ Plafond en panneau avec aération 4m x 3m/ Melamindecke inkl. Belüftung 4 mt x 3 mt	-	-	-	-	11721	-	-	-	-	-	-	-	-	-	-	-
MXST011	4m x 3m upholstered ceiling with ventilation/ Plafond en tissu avec aération 4m x 3m/ Stoffdecke inkl. Belüftung 4 mt x 3 mt	-	-	-	-	14373	-	-	-	-	-	-	-	-	-	-	-
MXSM012	4m x 3m solid ceiling without ventilation/ Plafond en panneau sans aération 4m x 3m/ Melamindecke ohne Belüftung 4 mt x 3 mt	-	-	-	-	5931	-	-	-	-	-	-	-	-	-	-	-
MXST012	4m x 3m upholstered ceiling without ventilation/ Plafond en tissu sans aération 4m x 3m/ Stoffdecke ohne Belüftung 4 mt x 3 mt	-	-	-	-	8584	-	-	-	-	-	-	-	-	-	-	-

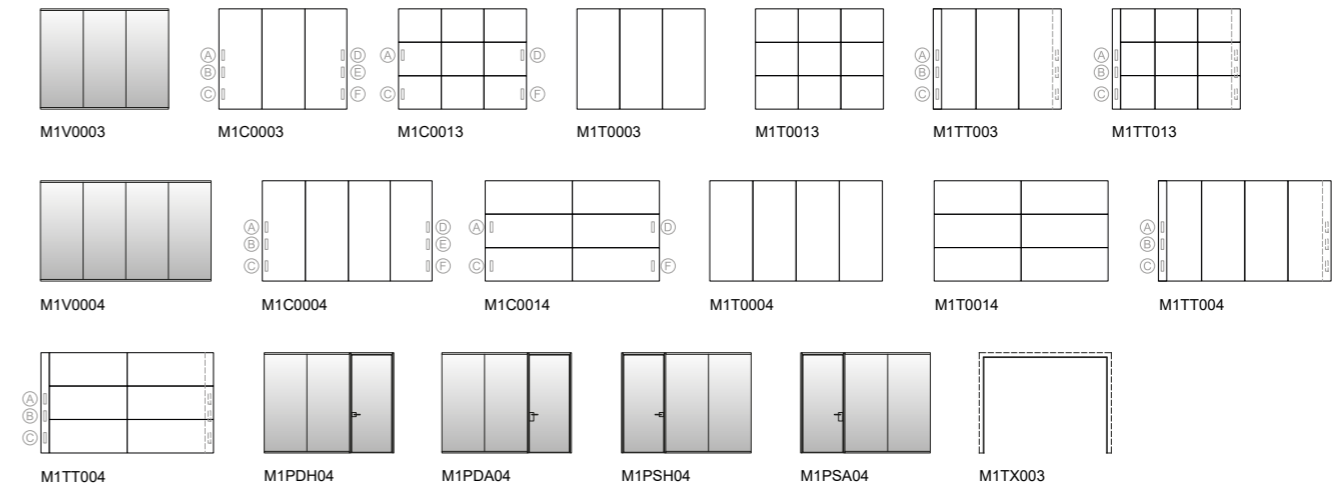

PLEASE NOTE: at least one solid wall panel is mandatory
 ATTENTION: Un côté plein toujours obligatoire
 WARNUNG: Eine geschlossene Wandstrecke ist immer erforderlich

1 2 3 4 5

Frosted glass
 Verre dépoli
 Satiniertes Glas

Tracks in anthracite
 Profils gris ombre
 Profile Dunkelgrau

Tracks in RAL of your choice
 Profils RAL au choix
 Profile nach RAL Farbkarte

Lacquered solid wall (1 side)
 Panneau RAL (1 côté)
 Paneel lackiert (einseitig)

Wood veneer solid wall (1 side)
 Panneau mélaminé (1 côté)
 Holzpaneel (einseitig)

Power modules / Multiprises / Mehrfachsteckdosen

EU (type F)
 S L

UK (type G)
 USA (type A)
 S L

3x4 acoustic booth - door in the middle of 3m wall
 Cabine acoustique 3x4 - porte côté 3 mètres centrale
 Akustikkabine 4 mt x 3 mt - mittige Tür auf 3 mt Seite

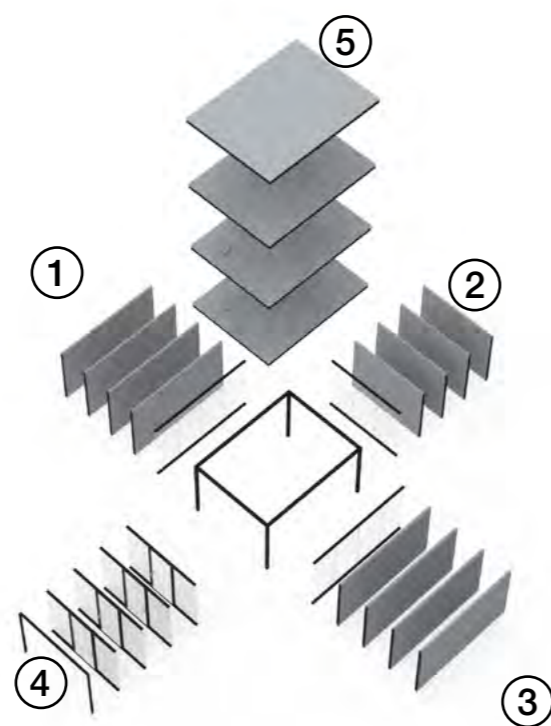
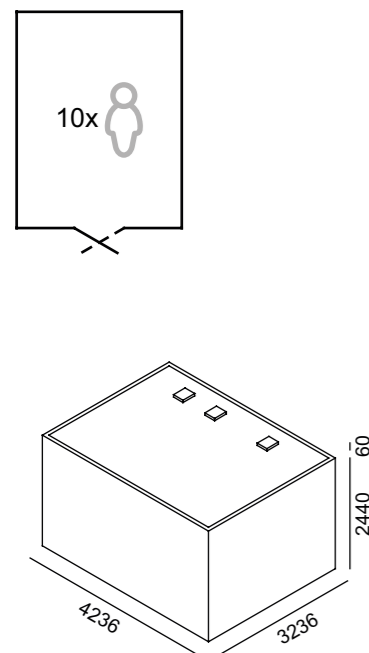

Cod. PBM11015

Code	Description	Wall Configuration					Glass & Tracks			Lacquered Solid Wall		Wood Veneer Solid Wall		Power modules / Multiprisen / Mehrfachsteckdosen			
		1	2	3	4	5	Frosted glass	Tracks in anthracite	Tracks in RAL of your choice	S	L	S	L	EU (type F)	USA (type A)		
M1V0003	3m single glazed wall/ Section vitrée 3m simple vitrage/ Wandstrecke 3 mt mit einfachem Glas	-	2757	-	-	-	+813	+190	+561	-	-	-	-	-	-	-	
M1V0004	4m single glazed wall/ Section vitrée 4m simple vitrage/ Wandstrecke 4 mt mit einfachem Glas	3552	-	3552	-	-	+1084	+244	+718	-	-	-	-	-	-		
M1C0003	3m solid wall/ Section panneau 3m vertical/ Geschlossene Melaminwandstrecke 3 mt breit vertikal	-	1788	-	-	-	-	+112	+331	+804	+3292	+348	+400	+395	+447		
M1C0013	3m tiled solid wall/ Section panneau 3m horizontal/ Geschlossene Melaminwandstrecke 3 mt breit horizontal	-	1977	-	-	-	-	+112	+331	+823	+3311	+348	+400	+395	+447		
M1T0003	3m solid wall, inner upholstery/ Section tissu 3m vertical/ Stoffwandstrecke 3 mt vertikal	-	3421	-	-	-	-	+112	+331	-	-	-	-	-	-		
M1T0013	3m tiled solid wall, inner upholstery/ Section tissu 3m horizontal/ Stoffwandstrecke 3 mt horizontal	-	5468	-	-	-	-	+112	+331	-	-	-	-	-	-		
M1TT003	3m solid wall, switch post, inner upholstery/ Section tissu 3m vertical avec module technique/ Stoffwandstrecke 3 mt vertikal mit Technikmodul	-	3726	-	-	-	-	+112	+331	-	-	+369	+421	+416	+468		
M1TT013	3m tiled solid wall, switch post, inner upholstery/ Section tissu 3m horizontal avec module technique/ Stoffwandstrecke 3 mt horizontal mit Technikmodul	-	5773	-	-	-	-	+112	+331	-	-	+369	+421	+416	+468		
M1C0004	4m solid wall/ Section panneau 4m vertical/ Geschlossene Melaminwandstrecke 4 mt breit vertikal	2182	-	2182	-	-	-	+123	+362	+1073	+4389	+348	+400	+395	+447		
M1C0014	4m tiled solid wall/ Section panneau 4m horizontal/ Geschlossene Melaminwandstrecke 4 mt breit horizontal	2581	-	2581	-	-	-	+123	+362	+1098	+4414	+348	+400	+395	+447		
M1T0004	4m solid wall, inner upholstery/ Section tissu 4m vertical/ Stoffwandstrecke 4 mt vertikal	4360	-	4360	-	-	-	+123	+362	-	-	-	-	-	-		
M1T0014	4m tiled solid wall, inner upholstery/ Section tissu 4m horizontal/ Stoffwandstrecke 4 mt horizontal	5797	-	5797	-	-	-	+123	+362	-	-	-	-	-	-		
M1TT004	4m solid wall, switch post, inner upholstery/ Section tissu 4m vertical avec module technique/ Stoffwandstrecke 4 mt vertikal mit Technikmodul	4664	-	4664	-	-	-	+123	+362	-	-	+369	+421	+416	+468		
M1TT014	4m tiled solid wall, switch post, inner upholstery/ Section tissu 4m horizontal avec module technique/ Stoffwandstrecke 4 mt horizontal mit Technikmodul	6102	-	6102	-	-	-	+123	+362	-	-	+369	+421	+416	+468		
M1PDH05	3m wall with middle RH door, HCS handle/ Section porte tirant droite, poignée HCS, 3m centrale/ Wandstrecke 3 mt mit mittiger rechten Tür Griff HCS	-	-	-	3705	-	+752	+243	+602	-	-	-	-	-	-		
M1PDA05	3m wall with middle RH door, AGB handle/ Section porte tirant droite, poignée AGB, 3m centrale/ Wandstrecke 3 mt mit mittiger rechten Tür Griff AGB	-	-	-	3705	-	+752	+243	+602	-	-	-	-	-	-		
M1PSH05	3m wall with middle LH door, HCS handle/ Section porte tirant gauche, poignée HCS, 3m centrale/ Wandstrecke 3 mt mit mittiger linken Tür Griff HCS	-	-	-	3705	-	+752	+243	+602	-	-	-	-	-	-		
M1PSA05	3m wall with middle LH door, AGB handle/ Section porte tirant gauche, poignée AGB, 3m centrale/ Wandstrecke 3 mt mit mittiger linken Tür Griff AGB	-	-	-	3705	-	+752	+243	+602	-	-	-	-	-	-		
M1TX003	3m open side/ Section ouverte 3m/ Offene Wandstrecke 3 Mt breit	-	-	-	164	-	-	+145	+425	-	-	-	-	-	-		
MXSM011	4m x 3m solid ceiling with ventilation/ Plafond en panneau avec aération 4m x 3m/ Melamindecke inkl. Belüftung 4 mt x 3 mt	-	-	-	-	11721	-	-	-	-	-	-	-	-	-		
MXST011	4m x 3m upholstered ceiling with ventilation/ Plafond en tissu avec aération 4m x 3m/ Stoffdecke inkl. Belüftung 4 mt x 3 mt	-	-	-	-	14373	-	-	-	-	-	-	-	-	-		
MXSM012	4m x 3m solid ceiling without ventilation/ Plafond en panneau sans aération 4m x 3m/ Melamindecke ohne Belüftung 4 mt x 3 mt	-	-	-	-	5931	-	-	-	-	-	-	-	-	-		
MXST012	4m x 3m upholstered ceiling without ventilation/ Plafond en tissu sans aération 4m x 3m/ Stoffdecke ohne Belüftung 4 mt x 3 mt	-	-	-	-	8584	-	-	-	-	-	-	-	-	-		

PLEASE NOTE: at least one solid wall panel is mandatory
 ATTENTION: Un côté plein toujours obligatoire
 WARNUNG: Eine geschlossene Wandstrecke ist immer erforderlich

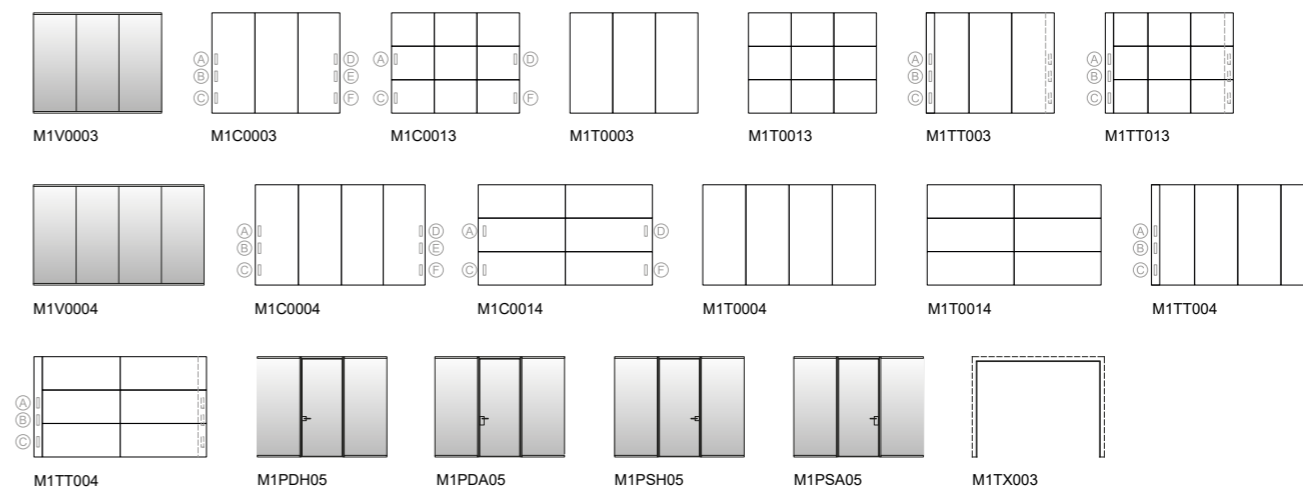

1 2 3 4 5

Frosted glass
Verre dépoli
Satiniertes Glas

Tracks in anthracite
Profilis gris ombre
Profilie Dunkelgrau

Tracks in RAL of your choice
Profilis RAL au choix
Profile nach RAL Farbkarte

Lacquered solid wall (1 side)
Panneau RAL (1 côté)
Paneeel lackiert (einseitig)

Wood veneer solid wall (1 side)
Panneau mélamin (1 côté)
Holzpaneeel (einseitig)

Power modules / Multiprisen / Mehrfachsteckdosen

EU (type F) S L UK (type G) USA (type A) S L

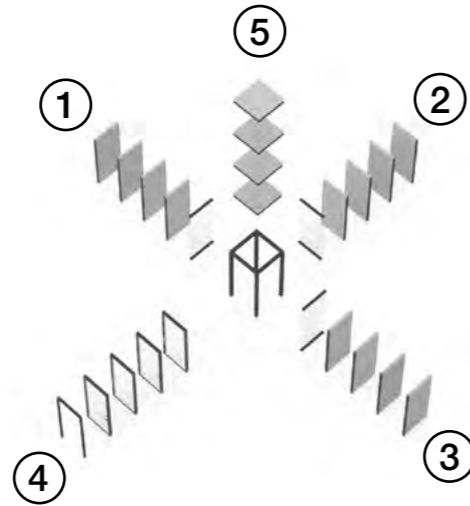
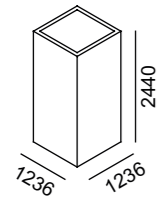
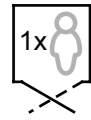

Cod. PBM22001

Code	Description	Wall Configuration					Glass Options			Track Options		Lacquered Solid Wall		Wood Veneer Solid Wall		Power Modules			
		1	2	3	4	5	Frosted glass	Tracks in anthracite	Tracks in RAL of your choice	Lacquered solid wall (1 side)	Wood veneer solid wall (1 side)	EU (type F)	UK (type G)	S	L	S	L		
M2V0001	1m double glazed wall/ Section vitrée 1m double vitrage/ Wandstrecke 1 mt mit Doppelglas	1819	1819	1819	-	-	+271	+95	+215	-	-	-	-	-	-	-	-	-	
M2C0001	1m solid wall/ Section panneau 1m vertical/ Geschlossene Melaminwandstrecke 1 mt breit vertikal	1001	1001	1001	-	-	-	+91	+268	+268	+1097	+348	+400	+395	+447				
M2C0011	1m tiled solid wall/ Section panneau 1m horizontal/ Geschlossene Melaminwandstrecke 1 mt breit horizontal	1064	1064	1064	-	-	-	+91	+268	+274	+1104	+348	+400	+395	+447				
M2T0001	1m solid wall, inner upholstery/ Section tissu 1m vertical/ Stoffwandstrecke 1 mt vertikal	1545	1545	1545	-	-	-	+91	+268	-	-	-	-	-	-	-	-	-	
M2T0011	1m tiled solid wall, inner upholstery/ Section tissu 1m horizontal/ Stoffwandstrecke 1 mt horizontal	2227	2227	2227	-	-	-	+91	+268	-	-	-	-	-	-	-	-	-	
M2TT001	1m solid wall, switch post, inner upholstery/ Section tissu 1m vertical avec module technique/ Stoffwandstrecke 1 mt vertikal mit Technikmodul	1850	1850	1850	-	-	-	+91	+268	-	-	+369	+421	+416	+468				
M2TT011	1m tiled solid wall, switch post, inner upholstery/ Section tissu 1m horizontal avec module technique/ Stoffwandstrecke 1 mt horizontal mit Technikmodul	2533	2533	2533	-	-	-	+91	+268	-	-	+369	+421	+416	+468				
M2PDH01	1m glazed RH door, HCS handle/ Section porte tirant droite, poignée HCS, 1m/ Wandstrecke 1 mt mit rechter Tür Griff HCS	-	-	-	2557	-	+210	+135	+287	-	-	-	-	-	-	-	-	-	
M2PDA01	1m glazed RH door, AGB handle/ Section porte tirant droite, poignée AGB, 1m/ Wandstrecke 1 mt mit rechter Tür Griff AGB	-	-	-	2557	-	+210	+135	+287	-	-	-	-	-	-	-	-	-	
M2PSH01	1m glazed LH door, HCS handle/ Section porte tirant gauche, poignée HCS, 1m/ Wandstrecke 1 mt mit linker Tür Griff HCS	-	-	-	2557	-	+210	+135	+287	-	-	-	-	-	-	-	-	-	
M2PSA01	1m glazed LH door, AGB handle/ Section porte tirant gauche, poignée AGB, 1m/ Wandstrecke 1 mt mit linker Tür Griff AGB	-	-	-	2557	-	+210	+135	+287	-	-	-	-	-	-	-	-	-	
M2TX001	1m open side/ Section ouverte 1m/ Offene Wandstrecke 1 Mt breit	-	-	-	156	-	-	+102	+299	-	-	-	-	-	-	-	-	-	
MXSM001	1m x 1m solid ceiling with ventilation/ Plafond en panneau avec aération 1m x 1m/ Melamindecke inkl. Belüftung 1 mt x 1 mt	-	-	-	-	3376	-	-	-	-	-	-	-	-	-	-	-	-	
MXST001	1m x 1m upholstered ceiling with ventilation/ Plafond en tissu avec aération 1m x 1m/ Stoffdecke inkl. Belüftung 1 mt x 1 mt	-	-	-	-	3963	-	-	-	-	-	-	-	-	-	-	-	-	
MXSM002	1m x 1m solid ceiling without ventilation/ Plafond en panneau sans aération 1m x 1m/ Melamindecke ohne Belüftung 1 mt x 1 mt	-	-	-	-	2065	-	-	-	-	-	-	-	-	-	-	-	-	
MXST002	1m x 1m upholstered ceiling without ventilation/ Plafond en tissu sans aération 1m x 1m/ Stoffdecke ohne Belüftung 1 mt x 1 mt	-	-	-	-	2652	-	-	-	-	-	-	-	-	-	-	-	-	

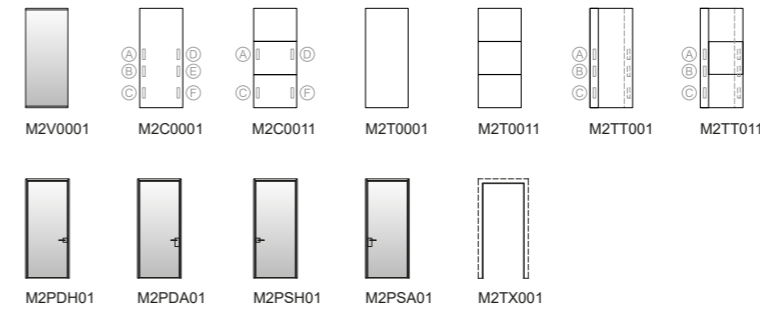

PLEASE NOTE: at least one solid wall panel is mandatory
ATTENTION: Un côté plein toujours obligatoire
WARNUNG: Eine geschlossene Wandstrecke ist immer erforderlich

1 2 3 4 5

Frosted glass		Tracks in anthracite		Tracks in RAL of your choice		Lacquered solid wall (1 side)		Wood veneer solid wall (1 side)		Power modules / Multipriees / Mehrfachsteckdosen			
Verre dépoli	Satinieretes Glas	Profilis gris ombre	Profilis Dunkelgrau	Profilis RAL au choix	Profilis nach RAL Farbkarte	Panneau RAL (1 côté)	Panneel lackiert (einseitig)	Panneau mélamin (1 côté)	Holzpaneel (einseitig)	EU (type F)		UK (type G)	
S	L	S	L	S	L	S	L	S	L	S	L	S	L
+271	+95	+91	+268	+91	+268	-	-	-	-	-	-	-	-
-	-	+91	+268	+91	+268	+268	+1097	+348	+400	+395	+447		
-	-	+91	+268	+91	+268	+274	+1104	+348	+400	+395	+447		
-	-	+91	+268	+91	+268	-	-	-	-	-	-	-	-
-	-	+91	+268	+91	+268	-	-	+369	+421	+416	+468		
-	-	+91	+268	+91	+268	-	-	+369	+421	+416	+468		
+210	+135	+287	-	-	-	-	-	-	-	-	-	-	-
+210	+135	+287	-	-	-	-	-	-	-	-	-	-	-
+210	+135	+287	-	-	-	-	-	-	-	-	-	-	-
-	+102	+299	-	-	-	-	-	-	-	-	-	-	-
-	-	-	-	-	-	-	-	-	-	-	-	-	-
-	-	-	-	-	-	-	-	-	-	-	-	-	-

2x1 acoustic booth - door on 2m wall
 Cabine acoustique 2x1 - porte côté 2 mètres
 Akustikkabine 2 mt x 1 mt - Tür auf 2 mt Seite

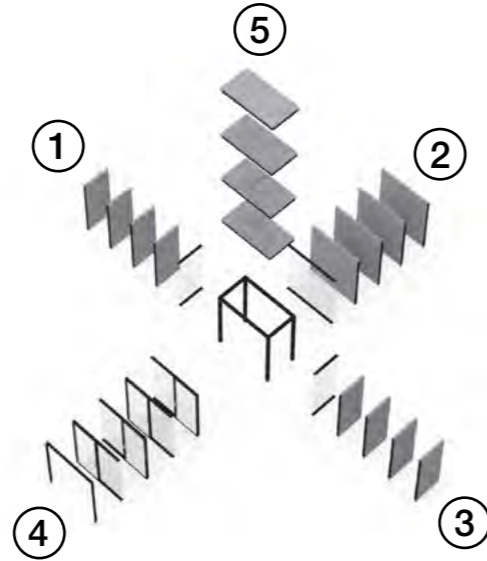
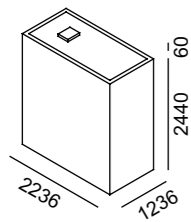
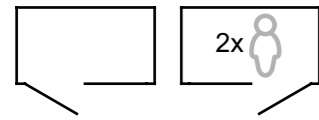

Cod. PBM22002

Code	Description
M2V0001	1m double glazed wall/ Section vitrée 1m double vitrage/ Wandstrecke 1 mt mit Doppelglas
M2V0002	2m double glazed wall/ Section vitrée 2m double vitrage/ Wandstrecke 2 mt mit Doppelglas
M2C0001	1m solid wall/ Section panneau 1m vertical/ Geschlossene Melaminwandstrecke 1 mt breit vertikal
M2C0011	1m tiled solid wall/ Section panneau 1m horizontal/ Geschlossene Melaminwandstrecke 1 mt breit horizontal
M2T0001	1m solid wall, inner upholstery/ Section tissu 1m vertical/ Stoffwandstrecke 1 mt vertikal
M2T0011	1m tiled solid wall, inner upholstery/ Section tissu 1m horizontal/ Stoffwandstrecke 1 mt horizontal
M2TT001	1m solid wall, switch post, inner upholstery/ Section tissu 1m vertical avec module technique/ Stoffwandstrecke 1 mt vertikal mit Technikmodul
M2TT011	1m tiled solid wall, switch post, inner upholstery/ Section tissu 1m horizontal avec module technique/ Stoffwandstrecke 1 mt horizontal mit Technikmodul
M2C0002	2m solid wall/ Section panneau 2m vertical/ Geschlossene Melaminwandstrecke 2 mt breit vertikal
M2C0012	2m tiled solid wall/ Section panneau 2m horizontal/ Geschlossene Melaminwandstrecke 2 mt breit horizontal
M2T0002	2m solid wall, inner upholstery/ Section tissu 2m vertical/ Stoffwandstrecke 2 mt vertikal
M2T0012	2m tiled solid wall, inner upholstery/ Section tissu 2m horizontal/ Stoffwandstrecke 2 mt horizontal
M2TT002	2m solid wall, switch post, inner upholstery/ Section tissu 2m vertical avec module technique/ Stoffwandstrecke 2 mt vertikal mit Technikmodul
M2TT012	2m tiled solid wall, switch post, inner upholstery/ Section tissu 2m horizontal avec module technique/ Stoffwandstrecke 2 mt horizontal mit Technikmodul
M2PDH02	2m glazed RH door, HCS handle/ Section porte tirant droite, poignée HCS, 2m/ Wandstrecke 2 mt mit rechter Tür Griff HCS
M2PDA02	2m glazed RH door, AGB handle/ Section porte tirant droite, poignée AGB, 2m/ Wandstrecke 2 mt mit rechter Tür Griff AGB
M2PSH02	2m glazed LH door, HCS handle/ Section porte tirant gauche, poignée HCS, 2m/ Wandstrecke 2 mt mit linker Tür Griff HCS
M2PSA02	2m glazed LH door, AGB handle/ Section porte tirant gauche, poignée AGB, 2m/ Wandstrecke 2 mt mit linker Tür Griff AGB
M2TX002	2m open side/ Section ouverte 2m/ Offene Wandstrecke 2 Mt breit
MXSM003	2m x 1m solid ceiling with ventilation/ Plafond en panneau avec aération 2m x 1m/ Melamindecke inkl. Belüftung 2 mt x 1 mt
MXST003	2m x 1m upholstered ceiling with ventilation/ Plafond en tissu avec aération 2m x 1m/ Stoffdecke inkl. Belüftung 2 mt x 1 mt
MXSM004	2m x 1m solid ceiling without ventilation/ Plafond en panneau sans aération 2m x 1m/ Melamindecke ohne Belüftung 2 mt x 1 mt
MXST004	2m x 1m upholstered ceiling without ventilation/ Plafond en tissu sans aération 2m x 1m/ Stoffdecke ohne Belüftung 2 mt x 1 mt

2x1 acoustic booth - door on 2m wall
 Cabine acoustique 2x1 - porte côté 2 mètres
 Akustikkabine 2 mt x 1 mt - Tür auf 2 mt Seite

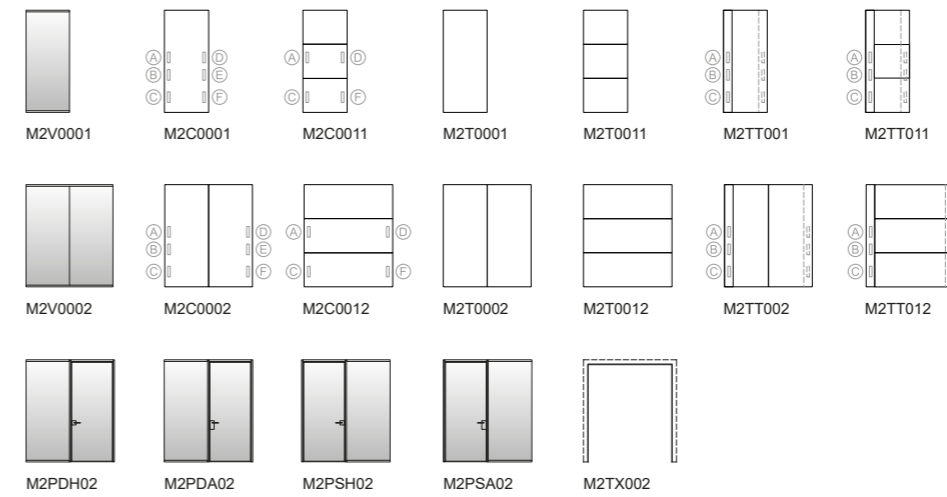

PLEASE NOTE: at least one solid wall panel is mandatory
 ATTENTION: Un côté plein toujours obligatoire
 WARNUNG: Eine geschlossene Wandstrecke ist immer erforderlich

	1 2 3 4 5					Frosted glass Verre dépoli Satiniertes Glas			Tracks in anthracite Profils gris ombre Profile Dunkelgrau			Tracks in RAL of your choice Profils RAL au choix Profile nach RAL Farbkarte			Lacquered solid wall (1 side) Panneau RAL (1 côté) Panneel lackiert (einseitig)		Wood veneer solid wall (1 side) Panneau mélamin (1 côté) Holzpaneel (einseitig)		Power modules / Multiprises / Mehrfachsteckdosen			
	S	L	S	L	S	L	S	L	S	L	S	L	S	L	S	L	S	L	S	L		
M2V0001	1819	-	1819	-	-	+271	+95	+215	-	-	-	-	-	-	-	-	-	-	-	-	-	
M2V0002	-	3245	-	-	-	+542	+160	+342	-	-	-	-	-	-	-	-	-	-	-	-	-	
M2C0001	1001	-	1001	-	-	-	+91	+268	+268	+1097	+348	+400	+395	+447	-	-	-	-	-	-	-	
M2C0011	1064	-	1064	-	-	-	+91	+268	+274	+1104	+348	+400	+395	+447	-	-	-	-	-	-	-	
M2T0001	1545	-	1545	-	-	-	+91	+268	-	-	-	-	-	-	-	-	-	-	-	-	-	
M2T0011	2227	-	2227	-	-	-	+91	+268	-	-	-	-	-	-	-	-	-	-	-	-	-	
M2TT001	1850	-	1850	-	-	-	+91	+268	-	-	+369	+421	+416	+468	-	-	-	-	-	-	-	
M2TT011	2533	-	2533	-	-	-	+91	+268	-	-	+369	+421	+416	+468	-	-	-	-	-	-	-	
M2C0002	-	1394	-	-	-	-	+102	+299	+537	+2195	+348	+400	+395	+447	-	-	-	-	-	-	-	
M2C0012	-	1594	-	-	-	-	+102	+299	+549	+2207	+348	+400	+395	+447	-	-	-	-	-	-	-	
M2T0002	-	2483	-	-	-	-	+102	+299	-	-	-	-	-	-	-	-	-	-	-	-	-	
M2T0012	-	3201	-	-	-	-	+102	+299	-	-	-	-	-	-	-	-	-	-	-	-	-	
M2TT002	-	2788	-	-	-	-	+102	+299	-	-	+369	+421	+416	+468	-	-	-	-	-	-	-	
M2TT012	-	3507	-	-	-	-	+102	+299	-	-	+369	+421	+416	+468	-	-	-	-	-	-	-	
M2PDH02	-	-	-	3983	-	+481	+189	+444	-	-	-	-	-	-	-	-	-	-	-	-	-	
M2PDA02	-	-	-	3983	-	+481	+189	+444	-	-	-	-	-	-	-	-	-	-	-	-	-	
M2PSH02	-	-	-	3983	-	+481	+189	+444	-	-	-	-	-	-	-	-	-	-	-	-	-	
M2PSA02	-	-	-	3983	-	+481	+189	+444	-	-	-	-	-	-	-	-	-	-	-	-	-	
M2TX002	-	-	-	161	-	-	+123	+362	-	-	-	-	-	-	-	-	-	-	-	-	-	
MXSM003	-	-	-	-	4711	-	-	-	-	-	-	-	-	-	-	-	-	-	-	-	-	
MXST003	-	-	-	-	5633	-	-	-	-	-	-	-	-	-	-	-	-	-	-	-	-	
MXSM004	-	-	-	-	2448	-	-	-	-	-	-	-	-	-	-	-	-	-	-	-	-	
MXST004	-	-	-	-	3368	-	-	-	-	-	-	-	-	-	-	-	-	-	-	-	-	

2x1 acoustic booth - door in the middle of 2m wall
 Cabine acoustique 2x1 - porte côté 2 mètres centrale
 Akustikkabine 2 mt x 1 mt - mittige Tür auf 2 mt Seite

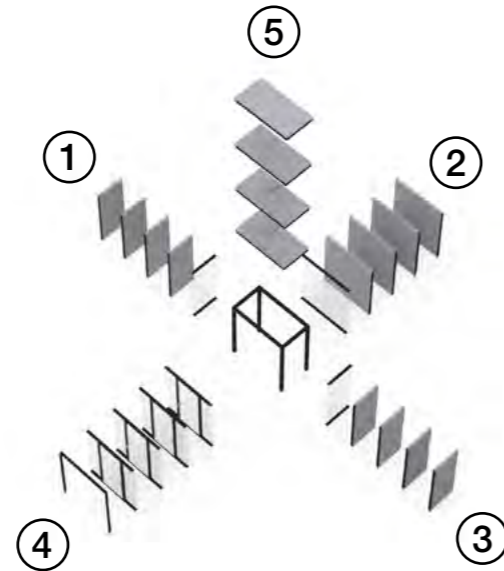
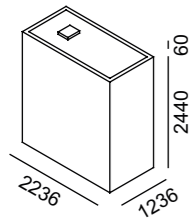
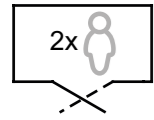

Cod. PBM22003

Cod.	Description	Configuration					Glass			Tracks		Lacquered solid wall		Wood veneer solid wall		Power modules			
		1	2	3	4	5	Frosted glass	Tracks in anthracite	Tracks in RAL of your choice	Lacquered solid wall (1 side)	Wood veneer solid wall (1 side)	EU (type F)	UK (type G)	USA (type A)	L				
M2V0001	1m double glazed wall/ Section vitrée 1m double vitrage/ Wandstrecke 1 mt mit Doppelglas	1819	-	1819	-	-	+271	+95	+215	-	-	-	-	-	-	-	-	-	-
M2V0002	2m double glazed wall/ Section vitrée 2m double vitrage/ Wandstrecke 2 mt mit Doppelglas	-	3245	-	-	-	+542	+160	+342	-	-	-	-	-	-	-	-	-	-
M2C0001	1m solid wall/ Section panneau 1m vertical/ Geschlossene Melaminwandstrecke 1 mt breit vertikal	1001	-	1001	-	-	-	+91	+268	+268	+1097	+348	+400	+395	+447	-	-	-	-
M2C0011	1m tiled solid wall/ Section panneau 1m horizontal/ Geschlossene Melaminwandstrecke 1 mt breit horizontal	1064	-	1064	-	-	-	+91	+268	+274	+1104	+348	+400	+395	+447	-	-	-	-
M2T0001	1m solid wall, inner upholstery/ Section tissu 1m vertical/ Stoffwandstrecke 1 mt vertikal	1545	-	1545	-	-	-	+91	+268	-	-	-	-	-	-	-	-	-	-
M2T0011	1m tiled solid wall, inner upholstery/ Section tissu 1m horizontal/ Stoffwandstrecke 1 mt horizontal	2227	-	2227	-	-	-	+91	+268	-	-	-	-	-	-	-	-	-	-
M2TT001	1m solid wall, switch post, inner upholstery/ Section tissu 1m vertical avec module technique/ Stoffwandstrecke 1 mt vertikal mit Technikmodul	1850	-	1850	-	-	-	+91	+268	-	-	+369	+421	+416	+468	-	-	-	-
M2TT011	1m tiled solid wall, switch post, inner upholstery/ Section tissu 1m horizontal avec module technique/ Stoffwandstrecke 1 mt horizontal mit Technikmodul	2533	-	2533	-	-	-	+91	+268	-	-	+369	+421	+416	+468	-	-	-	-
M2C0002	2m solid wall/ Section panneau 2m vertical/ Geschlossene Melaminwandstrecke 2 mt breit vertikal	-	1394	-	-	-	-	+102	+299	+537	+2195	+348	+400	+395	+447	-	-	-	-
M2C0012	2m tiled solid wall/ Section panneau 2m horizontal/ Geschlossene Melaminwandstrecke 2 mt breit horizontal	-	1594	-	-	-	-	+102	+299	+549	+2207	+348	+400	+395	+447	-	-	-	-
M2T0002	2m solid wall, inner upholstery/ Section tissu 2m vertical/ Stoffwandstrecke 2 mt vertikal	-	2483	-	-	-	-	+102	+299	-	-	-	-	-	-	-	-	-	-
M2T0012	2m tiled solid wall, inner upholstery/ Section tissu 2m horizontal/ Stoffwandstrecke 2 mt horizontal	-	3201	-	-	-	-	+102	+299	-	-	-	-	-	-	-	-	-	-
M2TT002	2m solid wall, switch post, inner upholstery/ Section tissu 2m vertical avec module technique/ Stoffwandstrecke 2 mt vertikal mit Technikmodul	-	2788	-	-	-	-	+102	+299	-	-	+369	+421	+416	+468	-	-	-	-
M2TT012	2m tiled solid wall, switch post, inner upholstery/ Section tissu 2m horizontal avec module technique/ Stoffwandstrecke 2 mt horizontal mit Technikmodul	-	3507	-	-	-	-	+102	+299	-	-	+369	+421	+416	+468	-	-	-	-
M2PDH03	2m wall with middle RH door, HCS handle/ Section porte tirant droite, poignée HCS, 2m centrale/ Wandstrecke 2 mt mit mittiger rechten Tür Griff HCS	-	-	-	4088	-	+481	+189	+444	-	-	-	-	-	-	-	-	-	-
M2PDA03	2m wall with middle RH door, AGB handle/ Section porte tirant droite, poignée AGB, 2m centrale/ Wandstrecke 2 mt mit mittiger rechten Tür Griff AGB	-	-	-	4088	-	+481	+189	+444	-	-	-	-	-	-	-	-	-	-
M2PSH03	2m wall with middle LH door, HCS handle/ Section porte tirant gauche, poignée HCS, 2m centrale/ Wandstrecke 2 mt mit mittiger linken Tür Griff HCS	-	-	-	4088	-	+481	+189	+444	-	-	-	-	-	-	-	-	-	-
M2PSA03	2m wall with middle LH door, AGB handle/ Section porte tirant gauche, poignée AGB, 2m centrale/ Wandstrecke 2 mt mit mittiger linken Tür Griff AGB	-	-	-	4088	-	+481	+189	+444	-	-	-	-	-	-	-	-	-	-
M2TX002	2m open side/ Section ouverte 2m/ Offene Wandstrecke 2 Mt breit	-	-	-	161	-	-	+123	+362	-	-	-	-	-	-	-	-	-	-
MXSM003	2m x 1m solid ceiling with ventilation/ Plafond en panneau avec aération 2m x 1m/ Melamindecke inkl. Belüftung 2 mt x 1 mt	-	-	-	-	4711	-	-	-	-	-	-	-	-	-	-	-	-	-
MXST003	2m x 1m upholstered ceiling with ventilation/ Plafond en tissu avec aération 2m x 1m/ Stoffdecke inkl. Belüftung 2 mt x 1 mt	-	-	-	-	5633	-	-	-	-	-	-	-	-	-	-	-	-	-
MXSM004	2m x 1m solid ceiling without ventilation/ Plafond en panneau sans aération 2m x 1m/ Melamindecke ohne Belüftung 2 mt x 1 mt	-	-	-	-	2448	-	-	-	-	-	-	-	-	-	-	-	-	-
MXST004	2m x 1m upholstered ceiling without ventilation/ Plafond en tissu sans aération 2m x 1m/ Stoffdecke ohne Belüftung 2 mt x 1 mt	-	-	-	-	3368	-	-	-	-	-	-	-	-	-	-	-	-	-

2x1 acoustic booth - door in the middle of 2m wall
 Cabine acoustique 2x1 - porte côté 2 mètres centrale
 Akustikkabine 2 mt x 1 mt - mittige Tür auf 2 mt Seite

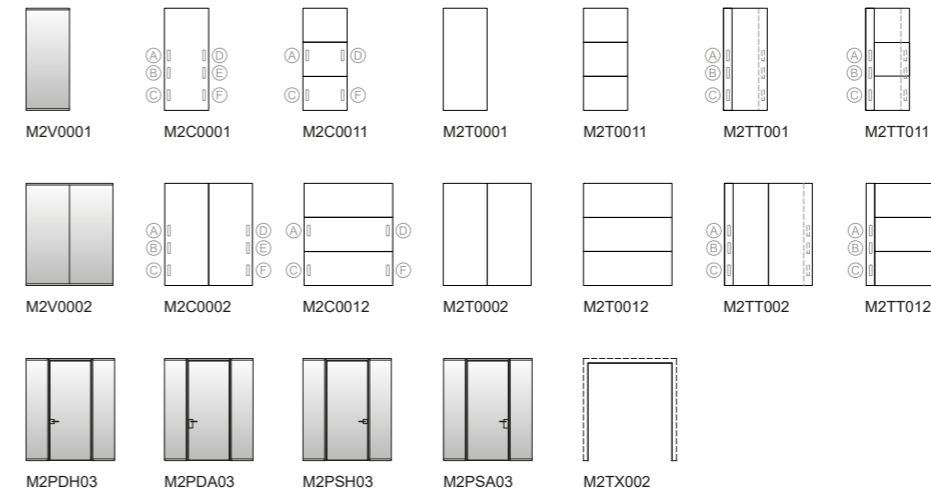

PLEASE NOTE: at least one solid wall panel is mandatory
 ATTENTION: Un côté plein toujours obligatoire
 WARNUNG: Eine geschlossene Wandstrecke ist immer erforderlich

1 2 3 4 5

Frosted glass	Tracks in anthracite	Tracks in RAL of your choice	Lacquered solid wall (1 side)	Wood veneer solid wall (1 side)	Power modules / Multipriees / Mehrfachsteckdosen			
					EU (type F)	UK (type G)	USA (type A)	L
Verre dépoli	Profils gris ombre	Profils RAL au choix	Panneau RAL (1 côté)	Panneau mélaminé (1 côté)	S	L	S	L
Satinierendes Glas	Profile Dunkelgrau	Profile nach RAL Farbkarte	Panneel lackiert (einseitig)	Holzpaneel (einseitig)				

XChange

M2 - 2x2

2x2 acoustic booth
Cabine acoustique 2x2
Akustikkabine 2 mt x 2 mt

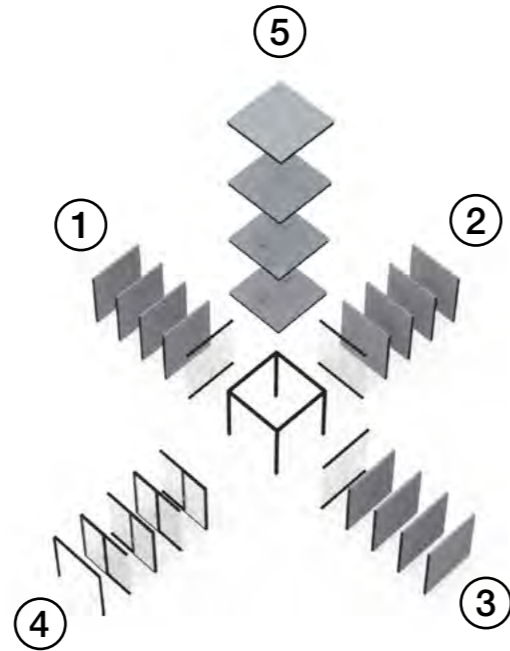
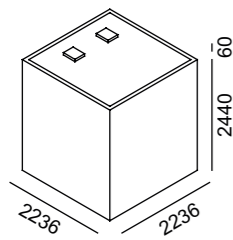
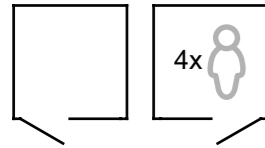

Cod. PBM22004

Code	Description
M2V0002	2m double glazed wall/ Section vitrée 2m double vitrage/ Wandstrecke 2 mt mit Doppelglas
M2C0002	2m solid wall/ Section panneau 2m vertical/ Geschlossene Melaminwandstrecke 2 mt breit vertikal
M2C0012	2m tiled solid wall/ Section panneau 2m horizontal/ Geschlossene Melaminwandstrecke 2 mt breit horizontal
M2T0002	2m solid wall, inner upholstery/ Section tissu 2m vertical/ Stoffwandstrecke 2 mt vertikal
M2T0012	2m tiled solid wall, inner upholstery/ Section tissu 2m horizontal/ Stoffwandstrecke 2 mt horizontal
M2TT002	2m solid wall, switch post, inner upholstery/ Section tissu 2m vertical avec module technique/ Stoffwandstrecke 2 mt vertikal mit Technikmodul
M2TT012	2m tiled solid wall, switch post, inner upholstery/ Section tissu 2m horizontal avec module technique/ Stoffwandstrecke 2 mt horizontal mit Technikmodul
M2PDH02	2m glazed RH door, HCS handle/ Section porte tirant droite, poignée HCS, 2m/ Wandstrecke 2 mt mit rechter Tür Griff HCS
M2PDA02	2m glazed RH door, AGB handle/ Section porte tirant droite, poignée AGB, 2m/ Wandstrecke 2 mt mit rechter Tür Griff AGB
M2PSH02	2m glazed LH door, HCS handle/ Section porte tirant gauche, poignée HCS, 2m/ Wandstrecke 2 mt mit linker Tür Griff HCS
M2PSA02	2m glazed LH door, AGB handle/ Section porte tirant gauche, poignée AGB, 2m/ Wandstrecke 2 mt mit linker Tür Griff AGB
M2TX002	2m open side/ Section ouverte 2m/ Offene Wandstrecke 2 Mt breit
MXSM005	2m x 2m solid ceiling with ventilation/ Plafond en panneau avec aération 2m x 2m/ Melamindecke inkl. Belüftung 2 mt x 2 mt
MXST005	2m x 2m upholstered ceiling with ventilation/ Plafond en tissu avec aération 2m x 2m/ Stoffdecke inkl. Belüftung 2 mt x 2 mt
MXSM006	2m x 2m solid ceiling without ventilation/ Plafond en panneau sans aération 2m x 2m/ Melamindecke ohne Belüftung 2 mt x 2 mt
MXST006	2m x 2m upholstered ceiling without ventilation/ Plafond en tissu sans aération 2m x 2m/ Stoffdecke ohne Belüftung 2 mt x 2 mt

2x2 acoustic booth
Cabine acoustique 2x2
Akustikkabine 2 mt x 2 mt

XChange

M2 - 2x2

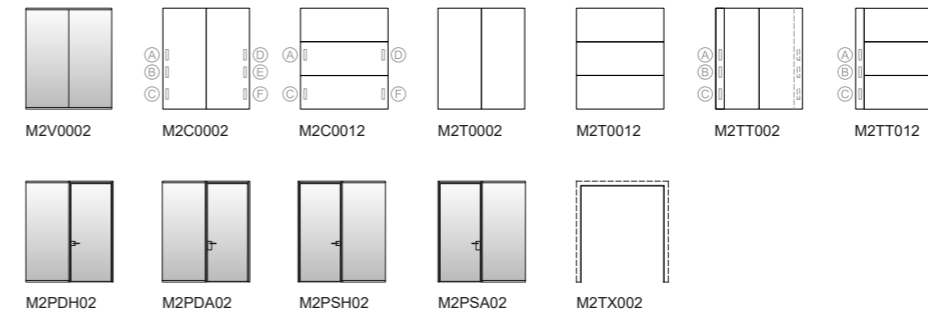

PLEASE NOTE: at least one solid wall panel is mandatory
ATTENTION: Un côté plein toujours obligatoire
WARNUNG: Eine geschlossene Wandstrecke ist immer erforderlich

1 2 3 4 5

	1	2	3	4	5	Frosted glass Verre dépoli Satiniertes Glas	Tracks in anthracite Profilis gris ombre Profilie Dunkelgrau	Tracks in RAL of your choice Profilis RAL au choix Profilie nach RAL Farbkarte	Lacquered solid wall (1 side) Panneau RAL (1 côté) Panneel lackiert (einseitig)	Wood veneer solid wall (1 side) Panneau mélamin (1 côté) Holzpaneel (einseitig)	Power modules / Multiprises / Mehrfachsteckdosen			
											EU (type F)		UK (type G) USA (type A)	
											S	L	S	L
M2V0002	3245	3245	3245	-	-	+542	+160	+342	-	-	-	-	-	-
M2C0002	1394	1394	1394	-	-	-	+102	+299	+537	+2195	+348	+400	+395	+447
M2C0012	1594	1594	1594	-	-	-	+102	+299	+549	+2207	+348	+400	+395	+447
M2T0002	2483	2483	2483	-	-	-	+102	+299	-	-	-	-	-	-
M2T0012	3201	3201	3201	-	-	-	+102	+299	-	-	-	-	-	-
M2TT002	2788	2788	2788	-	-	-	+102	+299	-	-	+369	+421	+416	+468
M2TT012	3507	3507	3507	-	-	-	+102	+299	-	-	+369	+421	+416	+468
M2PDH02	-	-	-	3983	-	+481	+189	+444	-	-	-	-	-	-
M2PDA02	-	-	-	3983	-	+481	+189	+444	-	-	-	-	-	-
M2PSH02	-	-	-	3983	-	+481	+189	+444	-	-	-	-	-	-
M2PSA02	-	-	-	3983	-	+481	+189	+444	-	-	-	-	-	-
M2TX002	-	-	-	161	-	-	+123	+362	-	-	-	-	-	-
MXSM005	-	-	-	-	6859	-	-	-	-	-	-	-	-	-
MXST005	-	-	-	-	7911	-	-	-	-	-	-	-	-	-
MXSM006	-	-	-	-	2826	-	-	-	-	-	-	-	-	-
MXST006	-	-	-	-	3879	-	-	-	-	-	-	-	-	-

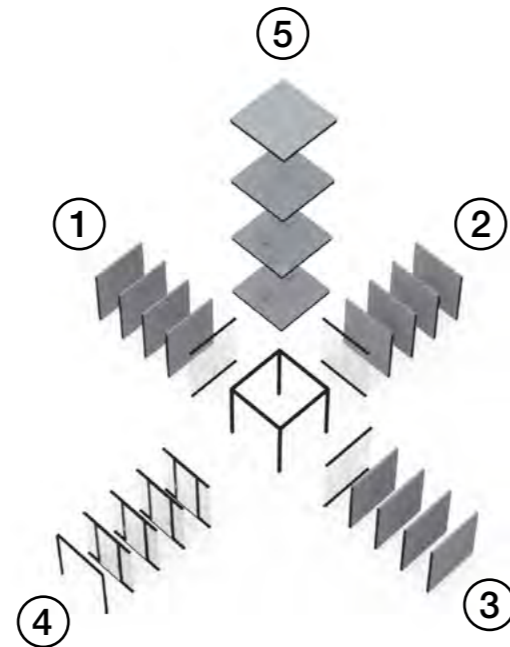
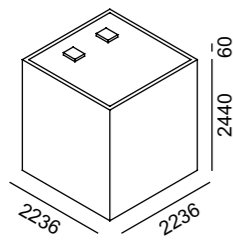
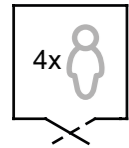

Cod. PBM22005

Code	Description
M2V0002	2m double glazed wall/ Section vitrée 2m double vitrage/ Wandstrecke 2 mt mit Doppelglas
M2C0002	2m solid wall/ Section panneau 2m vertical/ Geschlossene Melaminwandstrecke 2 mt breit vertikal
M2C0012	2m tiled solid wall/ Section panneau 2m horizontal/ Geschlossene Melaminwandstrecke 2 mt breit horizontal
M2T0002	2m solid wall, inner upholstery/ Section tissu 2m vertical/ Stoffwandstrecke 2 mt vertikal
M2T0012	2m tiled solid wall, inner upholstery/ Section tissu 2m horizontal/ Stoffwandstrecke 2 mt horizontal
M2TT002	2m solid wall, switch post, inner upholstery/ Section tissu 2m vertical avec module technique/ Stoffwandstrecke 2 mt vertikal mit Technikmodul
M2TT012	2m tiled solid wall, switch post, inner upholstery/ Section tissu 2m horizontal avec module technique/ Stoffwandstrecke 2 mt horizontal mit Technikmodul
M2PDH03	2m wall with middle RH door, HCS handle/ Section porte tirant droite, poignée HCS, 2m centrale/ Wandstrecke 2 mt mit mittiger rechten Tür Griff HCS
M2PDA03	2m wall with middle RH door, AGB handle/ Section porte tirant droite, poignée AGB, 2m centrale/ Wandstrecke 2 mt mit mittiger rechten Tür Griff AGB
M2PSH03	2m wall with middle LH door, HCS handle/ Section porte tirant gauche, poignée HCS, 2m centrale/ Wandstrecke 2 mt mit mittiger linken Tür Griff HCS
M2PSA03	2m wall with middle LH door, AGB handle/ Section porte tirant gauche, poignée AGB, 2m centrale/ Wandstrecke 2 mt mit mittiger linken Tür Griff AGB
M2TX002	2m open side/ Section ouverte 2m/ Offene Wandstrecke 2 Mt breit
MXSM005	2m x 2m solid ceiling with ventilation/ Plafond en panneau avec aération 2m x 2m/ Melamindecke inkl. Belüftung 2 mt x 2 mt
MXST005	2m x 2m upholstered ceiling with ventilation/ Plafond en tissu avec aération 2m x 2m/ Stoffdecke inkl. Belüftung 2 mt x 2 mt
MXSM006	2m x 2m solid ceiling without ventilation/ Plafond en panneau sans aération 2m x 2m/ Melamindecke ohne Belüftung 2 mt x 2 mt
MXST006	2m x 2m upholstered ceiling without ventilation/ Plafond en tissu sans aération 2m x 2m/ Stoffdecke ohne Belüftung 2 mt x 2 mt

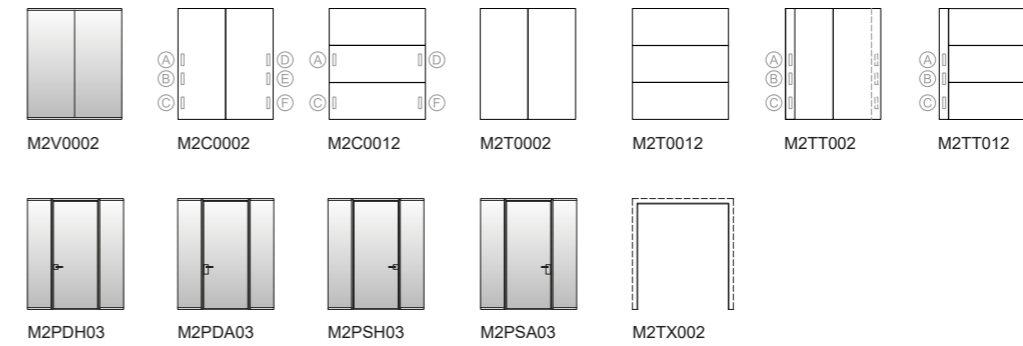

PLEASE NOTE: at least one solid wall panel is mandatory
ATTENTION: Un côté plein toujours obligatoire
WARNUNG: Eine geschlossene Wandstrecke ist immer erforderlich

1 2 3 4 5

	1 2 3 4 5					Frosted glass Verre dépoli Satiniertes Glas	Tracks in anthracite Profilis gris ombre Profilie Dunkelgrau	Tracks in RAL of your choice Profilis RAL au choix Profilie nach RAL Farbkarte	Lacquered solid wall (1 side) Panneau RAL (1 côté) Panneel lackiert (einseitig)	Wood veneer solid wall (1 side) Panneau mélamin (1 côté) Holzpaneeel (einseitig)	Power modules / Multiprises / Mehrfachsteckdosen			
	S	L	S	L	EU (type F)						USA (type A)			
M2V0002	3245	3245	3245	-	-	+542	+160	+342	-	-	-	-	-	-
M2C0002	1394	1394	1394	-	-	-	+102	+299	+537	+2195	+348	+400	+395	+447
M2C0012	1594	1594	1594	-	-	-	+102	+299	+549	+2207	+348	+400	+395	+447
M2T0002	2483	2483	2483	-	-	-	+102	+299	-	-	-	-	-	-
M2T0012	3201	3201	3201	-	-	-	+102	+299	-	-	-	-	-	-
M2TT002	2788	2788	2788	-	-	-	+102	+299	-	-	+369	+421	+416	+468
M2TT012	3507	3507	3507	-	-	-	+102	+299	-	-	+369	+421	+416	+468
M2PDH03	-	-	-	4088	-	+481	+189	+444	-	-	-	-	-	-
M2PDA03	-	-	-	4088	-	+481	+189	+444	-	-	-	-	-	-
M2PSH03	-	-	-	4088	-	+481	+189	+444	-	-	-	-	-	-
M2PSA03	-	-	-	4088	-	+481	+189	+444	-	-	-	-	-	-
M2TX002	-	-	-	161	-	-	+123	+362	-	-	-	-	-	-
MXSM005	-	-	-	-	6859	-	-	-	-	-	-	-	-	-
MXST005	-	-	-	-	7911	-	-	-	-	-	-	-	-	-
MXSM006	-	-	-	-	2826	-	-	-	-	-	-	-	-	-
MXST006	-	-	-	-	3879	-	-	-	-	-	-	-	-	-

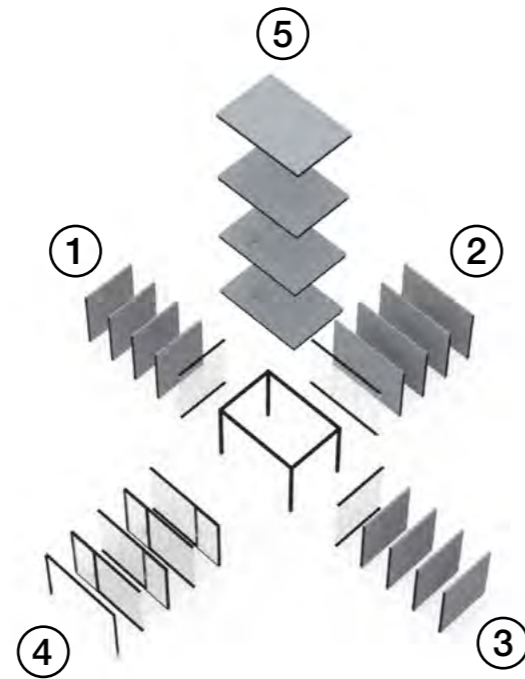
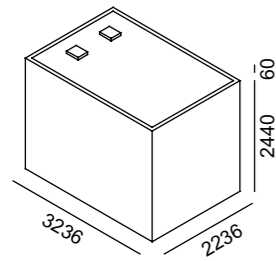
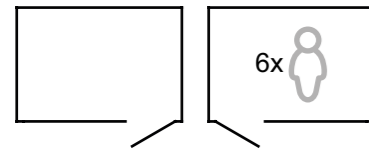

Cod. PBM22006

Code	Description	1	2	3	4	5
M2V0002	2m double glazed wall/ Section vitrée 2m double vitrage/ Wandstrecke 2 mt mit Doppelglas	3245	-	3245	-	-
M2V0003	3m double glazed wall/ Section vitrée 3m double vitrage/ Wandstrecke 3 mt mit Doppelglas	-	4670	-	-	-
M2C0002	2m solid wall/ Section panneau 2m vertical/ Geschlossene Melaminwandstrecke 2 mt breit vertikal	1394	-	1394	-	-
M2C0012	2m tiled solid wall/ Section panneau 2m horizontal/ Geschlossene Melaminwandstrecke 2 mt breit horizontal	1594	-	1594	-	-
M2T0002	2m solid wall, inner upholstery/ Section tissu 2m vertical/ Stoffwandstrecke 2 mt vertikal	2483	-	2483	-	-
M2T0012	2m tiled solid wall, inner upholstery/ Section tissu 2m horizontal/ Stoffwandstrecke 2 mt horizontal	3201	-	3201	-	-
M2TT002	2m solid wall, switch post, inner upholstery/ Section tissu 2m vertical avec module technique/ Stoffwandstrecke 2 mt vertikal mit Technikmodul	2788	-	2788	-	-
M2TT012	2m tiled solid wall, switch post, inner upholstery/ Section tissu 2m horizontal avec module technique/ Stoffwandstrecke 2 mt horizontal mit Technikmodul	3507	-	3507	-	-
M2C0003	3m solid wall/ Section panneau 3m vertical/ Geschlossene Melaminwandstrecke 3 mt breit vertikal	-	1788	-	-	-
M2C0013	3m tiled solid wall/ Section panneau 3m horizontal/ Geschlossene Melaminwandstrecke 3 mt breit horizontal	-	1977	-	-	-
M2T0003	3m solid wall, inner upholstery/ Section tissu 3m vertical/ Stoffwandstrecke 3 mt vertikal	-	3421	-	-	-
M2T0013	3m tiled solid wall, inner upholstery/ Section tissu 3m horizontal/ Stoffwandstrecke 3 mt horizontal	-	5468	-	-	-
M2TT003	3m solid wall, switch post, inner upholstery/ Section tissu 3m vertical avec module technique/ Stoffwandstrecke 3 mt vertikal mit Technikmodul	-	3726	-	-	-
M2TT013	3m tiled solid wall, switch post, inner upholstery/ Section tissu 3m horizontal avec module technique/ Stoffwandstrecke 3 mt horizontal mit Technikmodul	-	5773	-	-	-
M2PDH04	3m glazed RH door, HCS handle/ Section porte tirant droite, poignée HCS, 3m/ Wandstrecke 3 mt mit rechter Tür Griff HCS	-	-	-	5409	-
M2PDA04	3m glazed RH door, AGB handle/ Section porte tirant droite, poignée AGB, 3m/ Wandstrecke 3 mt mit rechter Tür Griff AGB	-	-	-	5409	-
M2PSH04	3m glazed LH door, HCS handle/ Section porte tirant gauche, poignée HCS, 3m/ Wandstrecke 3 mt mit linker Tür Griff HCS	-	-	-	5409	-
M2PSA04	3m glazed LH door, AGB handle/ Section porte tirant gauche, poignée AGB, 3m/ Wandstrecke 3 mt mit linker Tür Griff AGB	-	-	-	5409	-
M2TX003	3m open side/ Section ouverte 3m/ Offene Wandstrecke 3 Mt breit	-	-	-	164	-
MXSM007	3m x 2m solid ceiling with ventilation/ Plafond en panneau avec aération 3m x 2m/ Melamindecke inkl. Belüftung 3 mt x 2 mt	-	-	-	-	7887
MXST007	3m x 2m upholstered ceiling with ventilation/ Plafond en tissu avec aération 3m x 2m/ Stoffdecke inkl. Belüftung 3 mt x 2 mt	-	-	-	-	9466
MXSM008	3m x 2m solid ceiling without ventilation/ Plafond en panneau sans aération 3m x 2m/ Melamindecke ohne Belüftung 3 mt x 2 mt	-	-	-	-	3855
MXST008	3m x 2m upholstered ceiling without ventilation/ Plafond en tissu sans aération 3m x 2m/ Stoffdecke ohne Belüftung 3 mt x 2 mt	-	-	-	-	5433

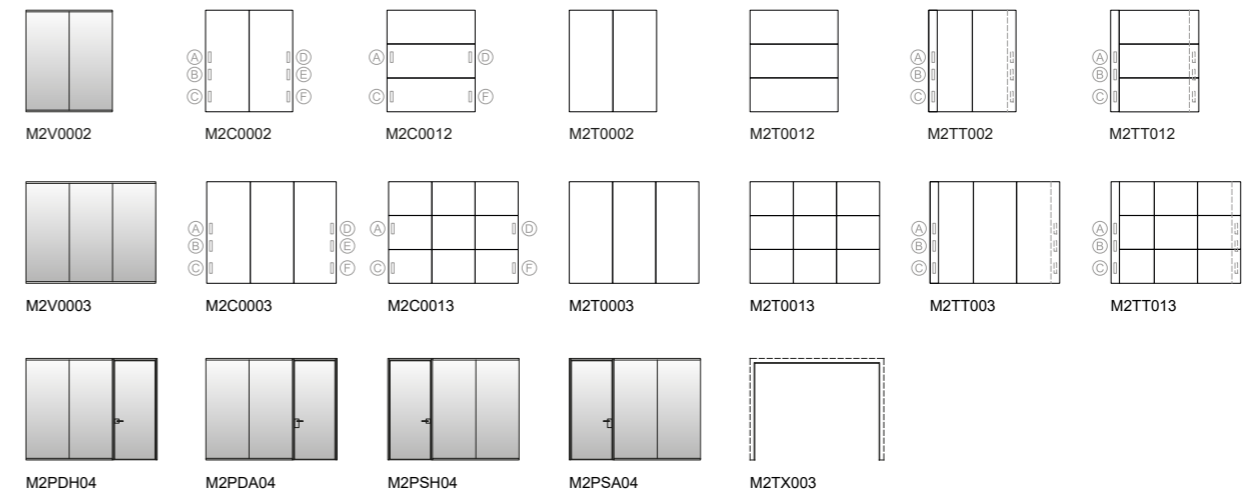

PLEASE NOTE: at least one solid wall panel is mandatory
 ATTENTION: Un côté plein toujours obligatoire
 WARNUNG: Eine geschlossene Wandstrecke ist immer erforderlich

1 2 3 4 5

Frosted glass Verre dépoli Satiniertes Glas	Tracks in anthracite Profilis gris ombre Profilie Dunkelgrau	Tracks in RAL of your choice Profilis RAL au choix Profile nach RAL Farbkarte	Lacquered solid wall (1 side) Panneau RAL (1 côté) Panneel lackiert (einseitig)	Wood veneer solid wall (1 side) Panneau mélamin (1 côté) Holzpaneeel (einseitig)	Power modules / Multiprises / Mehrfachsteckdosen			
					EU (type F) S L		UK (type G) USA (type A) S L	
+542	+160	+342	-	-	-	-	-	-
+813	+225	+469	-	-	-	-	-	-
-	+102	+299	+537	+2195	+348	+400	+395	+447
-	+102	+299	+549	+2207	+348	+400	+395	+447
-	+102	+299	-	-	-	-	-	-
-	+102	+299	-	-	-	-	-	-
-	+102	+299	-	-	+369	+421	+416	+468
-	+102	+299	-	-	+369	+421	+416	+468
-	+112	+331	+804	+3292	+348	+400	+395	+447
-	+112	+331	+823	+3311	+348	+400	+395	+447
-	+112	+331	-	-	-	-	-	-
-	+112	+331	-	-	+369	+421	+416	+468
-	+112	+331	-	-	+369	+421	+416	+468
+752	+243	+602	-	-	-	-	-	-
+752	+243	+602	-	-	-	-	-	-
+752	+243	+602	-	-	-	-	-	-
+752	+243	+602	-	-	-	-	-	-
-	+145	+425	-	-	-	-	-	-
-	-	-	-	-	-	-	-	-
-	-	-	-	-	-	-	-	-
-	-	-	-	-	-	-	-	-

XChange

M2 - 2x3

2x3 acoustic booth - door on 2m wall
 Cabine acoustique 2x3 - porte côté 2 mètres
 Akustikkabine 3 mt x 2 mt - Tür auf 2 mt Seite

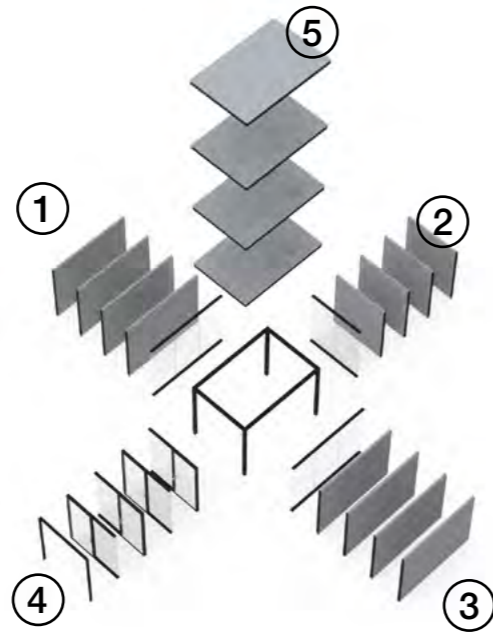
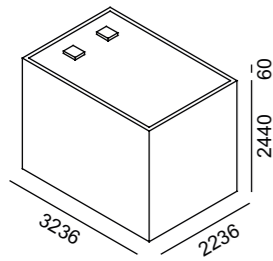
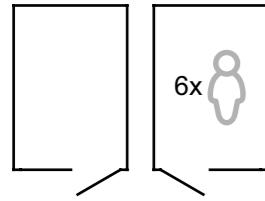

Cod. PBM22008

		1	2	3	4	5
M2V0002	2m double glazed wall/ Section vitrée 2m double vitrage/ Wandstrecke 2 mt mit Doppelglas	-	3245	-	-	-
M2V0003	3m double glazed wall/ Section vitrée 3m double vitrage/ Wandstrecke 3 mt mit Doppelglas	4670	-	4670	-	-
M2C0002	2m solid wall/ Section panneau 2m vertical/ Geschlossene Melaminwandstrecke 2 mt breit vertikal	-	1394	-	-	-
M2C0012	2m tiled solid wall/ Section panneau 2m horizontal/ Geschlossene Melaminwandstrecke 2 mt breit horizontal	-	1594	-	-	-
M2T0002	2m solid wall, inner upholstery/ Section tissu 2m vertical/ Stoffwandstrecke 2 mt vertikal	-	2483	-	-	-
M2T0012	2m tiled solid wall, inner upholstery/ Section tissu 2m horizontal/ Stoffwandstrecke 2 mt horizontal	-	3201	-	-	-
M2TT002	2m solid wall, switch post, inner upholstery/ Section tissu 2m vertical avec module technique/ Stoffwandstrecke 2 mt vertikal mit Technikmodul	-	2788	-	-	-
M2TT012	2m tiled solid wall, switch post, inner upholstery/ Section tissu 2m horizontal avec module technique/ Stoffwandstrecke 2 mt horizontal mit Technikmodul	-	3507	-	-	-
M2C0003	3m solid wall/ Section panneau 3m vertical/ Geschlossene Melaminwandstrecke 3 mt breit vertikal	1788	-	1788	-	-
M2C0013	3m tiled solid wall/ Section panneau 3m horizontal/ Geschlossene Melaminwandstrecke 3 mt breit horizontal	1977	-	1977	-	-
M2T0003	3m solid wall, inner upholstery/ Section tissu 3m vertical/ Stoffwandstrecke 3 mt vertikal	3421	-	3421	-	-
M2T0013	3m tiled solid wall, inner upholstery/ Section tissu 3m horizontal/ Stoffwandstrecke 3 mt horizontal	5468	-	5468	-	-
M2TT003	3m solid wall, switch post, inner upholstery/ Section tissu 3m vertical avec module technique/ Stoffwandstrecke 3 mt vertikal mit Technikmodul	3726	-	3726	-	-
M2TT013	3m tiled solid wall, switch post, inner upholstery/ Section tissu 3m horizontal avec module technique/ Stoffwandstrecke 3 mt horizontal mit Technikmodul	5773	-	5773	-	-
M2PDH02	2m glazed RH door, HCS handle/ Section porte tirant droite, poignée HCS, 2m/ Wandstrecke 2 mt mit rechter Tür Griff HCS	-	-	-	3983	-
M2PDA02	2m glazed RH door, AGB handle/ Section porte tirant droite, poignée AGB, 2m/ Wandstrecke 2 mt mit rechter Tür Griff AGB	-	-	-	3983	-
M2PSH02	2m glazed LH door, HCS handle/ Section porte tirant gauche, poignée HCS, 2m/ Wandstrecke 2 mt mit linker Tür Griff HCS	-	-	-	3983	-
M2PSA02	2m glazed LH door, AGB handle/ Section porte tirant gauche, poignée AGB, 2m/ Wandstrecke 2 mt mit linker Tür Griff AGB	-	-	-	3983	-
M2TX002	2m open side/ Section ouverte 2m/ Offene Wandstrecke 2 Mt breit	-	-	-	161	-
MXSM007	3m x 2m solid ceiling with ventilation/ Plafond en panneau avec aération 3m x 2m/ Melamindecke inkl. Belüftung 3 mt x 2 mt	-	-	-	-	7887
MXST007	3m x 2m upholstered ceiling with ventilation/ Plafond en tissu avec aération 3m x 2m/ Stoffdecke inkl. Belüftung 3 mt x 2 mt	-	-	-	-	9466
MXSM008	3m x 2m solid ceiling without ventilation/ Plafond en panneau sans aération 3m x 2m/ Melamindecke ohne Belüftung 3 mt x 2 mt	-	-	-	-	3855
MXST008	3m x 2m upholstered ceiling without ventilation/ Plafond en tissu sans aération 3m x 2m/ Stoffdecke ohne Belüftung 3 mt x 2 mt	-	-	-	-	5433

2x3 acoustic booth - door on 2m wall
 Cabine acoustique 2x3 - porte côté 2 mètres
 Akustikkabine 3 mt x 2 mt - Tür auf 2 mt Seite

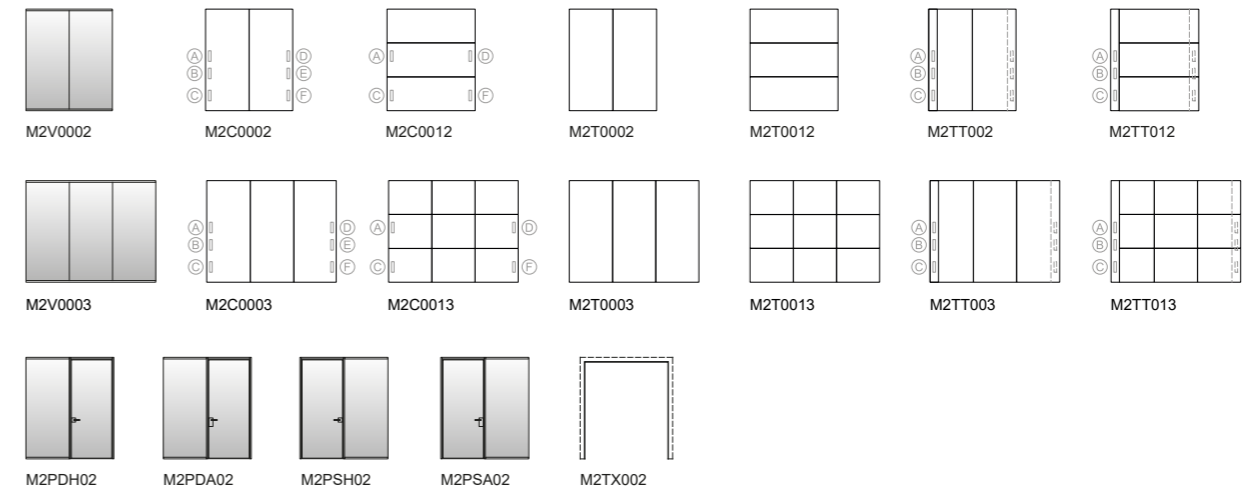

PLEASE NOTE: at least one solid wall panel is mandatory
 ATTENTION: Un côté plein toujours obligatoire
 WARNUNG: Eine geschlossene Wandstrecke ist immer erforderlich

1 2 3 4 5

	1	2	3	4	5	Frosted glass Verre dépoli Satiniertes Glas	Tracks in anthracite Profilis gris ombre Profil Dunkelgrau	Tracks in RAL of your choice Profilis RAL au choix Profile nach RAL Farbkarte	Lacquered solid wall (1 side) Panneau RAL (1 côté) Panneel lackiert (einseitig)	Wood veneer solid wall (1 side) Panneau mélamin (1 côté) Holzpaneeel (einseitig)	Power modules / Multiprises / Mehrfachsteckdosen			
											EU (type F)		UK (type G) USA (type A)	
											S	L	S	L
M2V0002	-	3245	-	-	-	+542	+160	+342	-	-	-	-	-	-
M2V0003	4670	-	4670	-	-	+813	+225	+469	-	-	-	-	-	-
M2C0002	-	1394	-	-	-	-	+102	+299	+537	+2195	+348	+400	+395	+447
M2C0012	-	1594	-	-	-	-	+102	+299	+549	+2207	+348	+400	+395	+447
M2T0002	-	2483	-	-	-	-	+102	+299	-	-	-	-	-	-
M2T0012	-	3201	-	-	-	-	+102	+299	-	-	-	-	-	-
M2TT002	-	2788	-	-	-	-	+102	+299	-	-	+369	+421	+416	+468
M2TT012	-	3507	-	-	-	-	+102	+299	-	-	+369	+421	+416	+468
M2C0003	1788	-	1788	-	-	-	+112	+331	+804	+3292	+348	+400	+395	+447
M2C0013	1977	-	1977	-	-	-	+112	+331	+823	+3311	+348	+400	+395	+447
M2T0003	3421	-	3421	-	-	-	+112	+331	-	-	-	-	-	-
M2T0013	5468	-	5468	-	-	-	+112	+331	-	-	-	-	-	-
M2TT003	3726	-	3726	-	-	-	+112	+331	-	-	+369	+421	+416	+468
M2TT013	5773	-	5773	-	-	-	+112	+331	-	-	+369	+421	+416	+468
M2PDH02	-	-	-	3983	-	+481	+189	+444	-	-	-	-	-	-
M2PDA02	-	-	-	3983	-	+481	+189	+444	-	-	-	-	-	-
M2PSH02	-	-	-	3983	-	+481	+189	+444	-	-	-	-	-	-
M2PSA02	-	-	-	3983	-	+481	+189	+444	-	-	-	-	-	-
M2TX002	-	-	-	161	-	-	+123	+362	-	-	-	-	-	-
MXSM007	-	-	-	-	7887	-	-	-	-	-	-	-	-	-
MXST007	-	-	-	-	9466	-	-	-	-	-	-	-	-	-
MXSM008	-	-	-	-	3855	-	-	-	-	-	-	-	-	-
MXST008	-	-	-	-	5433	-	-	-	-	-	-	-	-	-

XChange

M2 - 2x3

2x3 acoustic booth - door in the middle of 2m wall
 Cabine acoustique 2x3 - porte côté 2 mètres centrale
 Akustikkabine 3 mt x 2 mt - mittige Tür auf 2 mt Seite

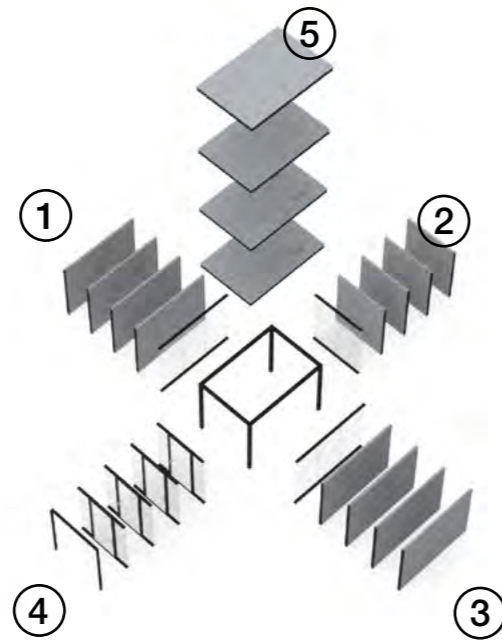
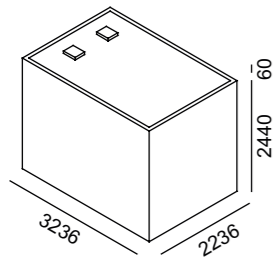
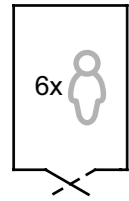

Cod. PBM22009

Cod.	Description	Wall Panels					Glass			Tracks		Lacquered solid wall		Wood veneer solid wall		Power modules			
		1	2	3	4	5	Frosted glass	Tracks in anthracite	Tracks in RAL of your choice	Lacquered solid wall (1 side)	Wood veneer solid wall (1 side)	EU (type F)	UK (type G)	USA (type A)					
						S	L	S	L	S	L	S	L	S	L	S	L		
M2V0002	2m double glazed wall/ Section vitrée 2m double vitrage/ Wandstrecke 2 mt mit Doppelglas	-	3245	-	-	-	+542	+160	+342	-	-	-	-	-	-	-	-		
M2V0003	3m double glazed wall/ Section vitrée 3m double vitrage/ Wandstrecke 3 mt mit Doppelglas	4670	-	4670	-	-	+813	+225	+469	-	-	-	-	-	-	-	-		
M2C0002	2m solid wall/ Section panneau 2m vertical/ Geschlossene Melaminwandstrecke 2 mt breit vertikal	-	1394	-	-	-	-	+102	+299	+537	+2195	+348	+400	+395	+447	-	-		
M2C0012	2m tiled solid wall/ Section panneau 2m horizontal/ Geschlossene Melaminwandstrecke 2 mt breit horizontal	-	1594	-	-	-	-	+102	+299	+549	+2207	+348	+400	+395	+447	-	-		
M2T0002	2m solid wall, inner upholstery/ Section tissu 2m vertical/ Stoffwandstrecke 2 mt vertikal	-	2483	-	-	-	-	+102	+299	-	-	-	-	-	-	-	-		
M2T0012	2m tiled solid wall, inner upholstery/ Section tissu 2m horizontal/ Stoffwandstrecke 2 mt horizontal	-	3201	-	-	-	-	+102	+299	-	-	-	-	-	-	-	-		
M2TT002	2m solid wall, switch post, inner upholstery/ Section tissu 2m vertical avec module technique/ Stoffwandstrecke 2 mt vertikal mit Technikmodul	-	2788	-	-	-	-	+102	+299	-	-	+369	+421	+416	+468	-	-		
M2TT012	2m tiled solid wall, switch post, inner upholstery/ Section tissu 2m horizontal avec module technique/ Stoffwandstrecke 2 mt horizontal mit Technikmodul	-	3507	-	-	-	-	+102	+299	-	-	+369	+421	+416	+468	-	-		
M2C0003	3m solid wall/ Section panneau 3m vertical/ Geschlossene Melaminwandstrecke 3 mt breit vertikal	1788	-	1788	-	-	-	+112	+331	+804	+3292	+348	+400	+395	+447	-	-		
M2C0013	3m tiled solid wall/ Section panneau 3m horizontal/ Geschlossene Melaminwandstrecke 3 mt breit horizontal	1977	-	1977	-	-	-	+112	+331	+823	+3311	+348	+400	+395	+447	-	-		
M2T0003	3m solid wall, inner upholstery/ Section tissu 3m vertical/ Stoffwandstrecke 3 mt vertikal	3421	-	3421	-	-	-	+112	+331	-	-	-	-	-	-	-	-		
M2T0013	3m tiled solid wall, inner upholstery/ Section tissu 3m horizontal/ Stoffwandstrecke 3 mt horizontal	5468	-	5468	-	-	-	+112	+331	-	-	-	-	-	-	-	-		
M2TT003	3m solid wall, switch post, inner upholstery/ Section tissu 3m vertical avec module technique/ Stoffwandstrecke 3 mt vertikal mit Technikmodul	3726	-	3726	-	-	-	+112	+331	-	-	+369	+421	+416	+468	-	-		
M2TT013	3m tiled solid wall, switch post, inner upholstery/ Section tissu 3m horizontal avec module technique/ Stoffwandstrecke 3 mt horizontal mit Technikmodul	5773	-	5773	-	-	-	+112	+331	-	-	+369	+421	+416	+468	-	-		
M2PDH03	2m wall with middle RH door, HCS handle/ Section porte tirant droite, poignée HCS, 2m centrale/ Wandstrecke 2 mt mit mittiger rechten Tür Griff HCS	-	-	-	4088	-	+481	+189	+444	-	-	-	-	-	-	-	-		
M2PDA03	2m wall with middle RH door, AGB handle/ Section porte tirant droite, poignée AGB, 2m centrale/ Wandstrecke 2 mt mit mittiger rechten Tür Griff AGB	-	-	-	4088	-	+481	+189	+444	-	-	-	-	-	-	-	-		
M2PSH03	2m wall with middle LH door, HCS handle/ Section porte tirant gauche, poignée HCS, 2m centrale/ Wandstrecke 2 mt mit mittiger linken Tür Griff HCS	-	-	-	4088	-	+481	+189	+444	-	-	-	-	-	-	-	-		
M2PSA03	2m wall with middle LH door, AGB handle/ Section porte tirant gauche, poignée AGB, 2m centrale/ Wandstrecke 2 mt mit mittiger linken Tür Griff AGB	-	-	-	4088	-	+481	+189	+444	-	-	-	-	-	-	-	-		
M2TX002	2m open side/ Section ouverte 2m/ Offene Wandstrecke 2 Mt breit	-	-	-	161	-	-	+123	+362	-	-	-	-	-	-	-	-		
MXSM007	3m x 2m solid ceiling with ventilation/ Plafond en panneau avec aération 3m x 2m/ Melamindecke inkl. Belüftung 3 mt x 2 mt	-	-	-	-	7887	-	-	-	-	-	-	-	-	-	-	-		
MXST007	3m x 2m upholstered ceiling with ventilation/ Plafond en tissu avec aération 3m x 2m/ Stoffdecke inkl. Belüftung 3 mt x 2 mt	-	-	-	-	9466	-	-	-	-	-	-	-	-	-	-	-		
MXSM008	3m x 2m solid ceiling without ventilation/ Plafond en panneau sans aération 3m x 2m/ Melamindecke ohne Belüftung 3 mt x 2 mt	-	-	-	-	3855	-	-	-	-	-	-	-	-	-	-	-		
MXST008	3m x 2m upholstered ceiling without ventilation/ Plafond en tissu sans aération 3m x 2m/ Stoffdecke ohne Belüftung 3 mt x 2 mt	-	-	-	-	5433	-	-	-	-	-	-	-	-	-	-	-		

2x3 acoustic booth - door in the middle of 2m wall
 Cabine acoustique 2x3 - porte côté 2 mètres centrale
 Akustikkabine 3 mt x 2 mt - mittige Tür auf 2 mt Seite

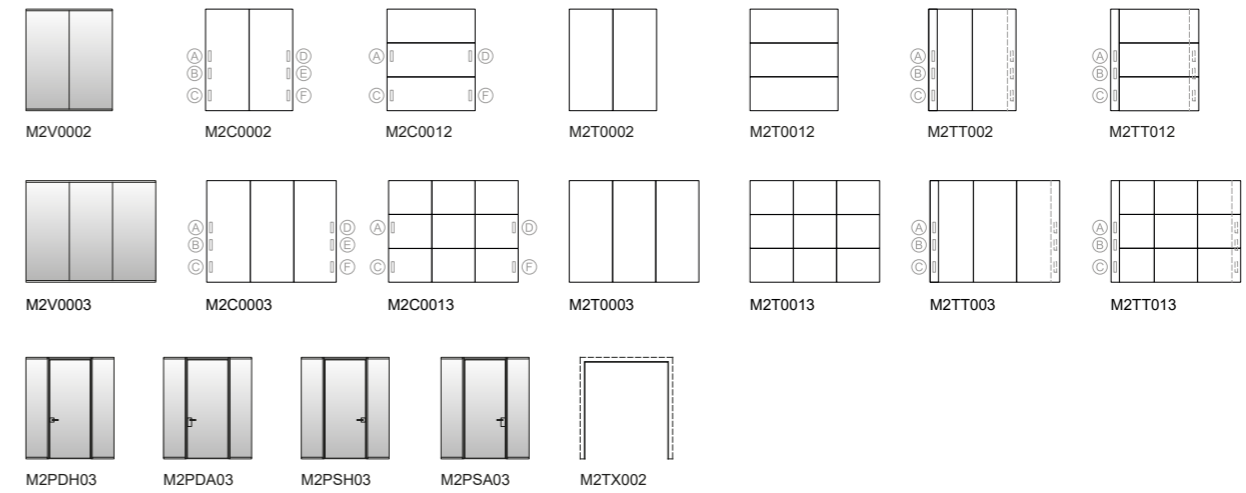

PLEASE NOTE: at least one solid wall panel is mandatory
 ATTENTION: Un côté plein toujours obligatoire
 WARNUNG: Eine geschlossene Wandstrecke ist immer erforderlich

1 2 3 4 5

Frosted glass		Tracks in anthracite		Tracks in RAL of your choice		Lacquered solid wall (1 side)		Wood veneer solid wall (1 side)		Power modules / Multiprises / Mehrfachsteckdosen			
Verre dépoli	Satinierteres Glas	Profilis gris ombre	Profilis Dunkelgrau	Profilis RAL au choix	Profilis nach RAL Farbkarte	Panneau RAL (1 côté)	Panneel lackiert (einseitig)	Panneau mélamin (1 côté)	Holzpaneeel (einseitig)	EU (type F)		UK (type G)	
S	L	S	L	S	L	S	L	S	L	S	L	S	L
+542	+160	+342	-	-	-	-	-	-	-	-	-	-	-
+813	+225	+469	-	-	-	-	-	-	-	-	-	-	-
-	+102	+299	+537	+2195	+348	+400	+395	+447	-	-	-	-	
-	+102	+299	+549	+2207	+348	+400	+395	+447	-	-	-	-	
-	+102	+299	-	-	-	-	-	-	-	-	-	-	
-	+102	+299	-	-	+369	+421	+416	+468	-	-	-	-	
-	+102	+299	-	-	+369	+421	+416	+468	-	-	-	-	
-	+112	+331	+804	+3292	+348	+400	+395	+447	-	-	-	-	
-	+112	+331	+823	+3311	+348	+400	+395	+447	-	-	-	-	
-	+112	+331	-	-	-	-	-	-	-	-	-	-	
-	+112	+331	-	-	+369	+421	+416	+468	-	-	-	-	
-	+112	+331	-	-	+369	+421	+416	+468	-	-	-	-	
-	+189	+444	-	-	-	-	-	-	-	-	-	-	
-	+189	+444	-	-	-	-	-	-	-	-	-	-	
-	+189	+444	-	-	-	-	-	-	-	-	-	-	
-	+123	+362	-	-	-	-	-	-	-	-	-	-	
-	-	-	-	-	-	-	-	-	-	-	-	-	
-	-	-	-	-	-	-	-	-	-	-	-	-	
-	-	-	-	-	-	-	-	-	-	-	-	-	

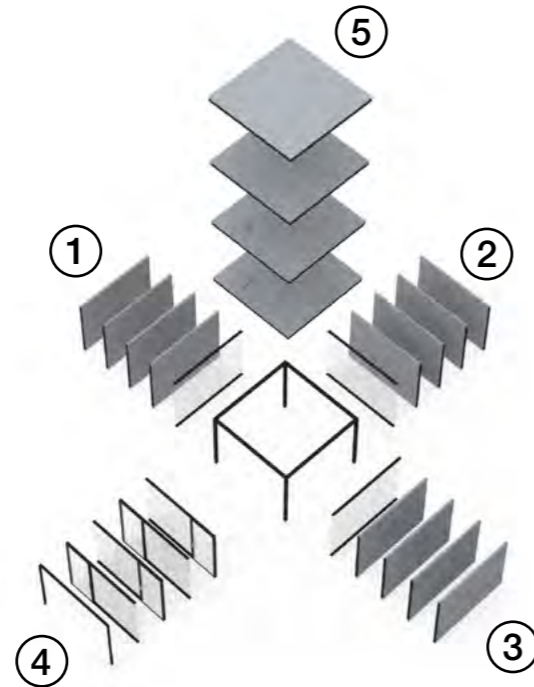
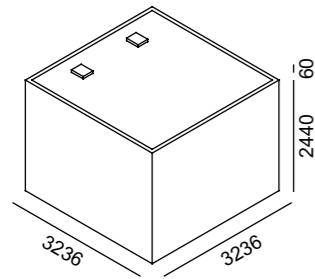
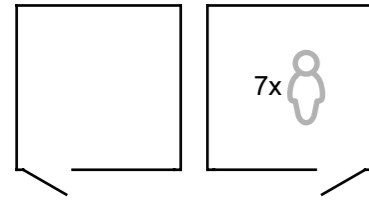

Cod. PBM22010

Code	Description	Configuration					Glass			Tracks		Lacquered solid wall		Wood veneer solid wall		Power modules			
		1	2	3	4	5	Frosted glass	Tracks in anthracite	Tracks in RAL of your choice	Lacquered solid wall (1 side)	Wood veneer solid wall (1 side)	EU (type F)	UK (type G)	USA (type A)	L				
M2V0003	3m double glazed wall/ Section vitrée 3m double vitrage/ Wandstrecke 3 mt mit Doppelglas	4670	4670	4670	-	-	+813	+225	+469	-	-	-	-	-	-	-	-	-	-
M2C0003	3m solid wall/ Section panneau 3m vertical/ Geschlossene Melaminwandstrecke 3 mt breit vertikal	1788	1788	1788	-	-	-	+112	+331	+804	+3292	+348	+400	+395	+447				
M2C0013	3m tiled solid wall/ Section panneau 3m horizontal/ Geschlossene Melaminwandstrecke 3 mt breit horizontal	1977	1977	1977	-	-	-	+112	+331	+823	+3311	+348	+400	+395	+447				
M2T0003	3m solid wall, inner upholstery/ Section tissu 3m vertical/ Stoffwandstrecke 3 mt vertikal	3421	3421	3421	-	-	-	+112	+331	-	-	-	-	-	-	-	-	-	-
M2T0013	3m tiled solid wall, inner upholstery/ Section tissu 3m horizontal/ Stoffwandstrecke 3 mt horizontal	5468	5468	5468	-	-	-	+112	+331	-	-	-	-	-	-	-	-	-	-
M2TT003	3m solid wall, switch post, inner upholstery/ Section tissu 3m vertical avec module technique/ Stoffwandstrecke 3 mt vertikal mit Technikmodul	3726	3726	3726	-	-	-	+112	+331	-	-	+369	+421	+416	+468				
M2TT013	3m tiled solid wall, switch post, inner upholstery/ Section tissu 3m horizontal avec module technique/ Stoffwandstrecke 3 mt horizontal mit Technikmodul	5773	5773	5773	-	-	-	+112	+331	-	-	+369	+421	+416	+468				
M2PDH04	3m glazed RH door, HCS handle/ Section porte tirant droite, poignée HCS, 3m/ Wandstrecke 3 mt mit rechter Tür Griff HCS	-	-	-	5409	-	+752	+243	+602	-	-	-	-	-	-	-	-	-	-
M2PDA04	3m glazed RH door, AGB handle/ Section porte tirant droite, poignée AGB, 3m/ Wandstrecke 3 mt mit rechter Tür Griff AGB	-	-	-	5409	-	+752	+243	+602	-	-	-	-	-	-	-	-	-	-
M2PSH04	3m glazed LH door, HCS handle/ Section porte tirant gauche, poignée HCS, 3m/ Wandstrecke 3 mt mit linker Tür Griff HCS	-	-	-	5409	-	+752	+243	+602	-	-	-	-	-	-	-	-	-	-
M2PSA04	3m glazed LH door, AGB handle/ Section porte tirant gauche, poignée AGB, 3m/ Wandstrecke 3 mt mit linker Tür Griff AGB	-	-	-	5409	-	+752	+243	+602	-	-	-	-	-	-	-	-	-	-
M2TX003	3m open side/ Section ouverte 3m/ Offene Wandstrecke 3 Mt breit	-	-	-	164	-	-	+145	+425	-	-	-	-	-	-	-	-	-	-
MXSM009	3m x 3m solid ceiling with ventilation/ Plafond en panneau avec aération 3m x 3m/ Melamindecke inkl. Belüftung 3 mt x 3 mt	-	-	-	-	8902	-	-	-	-	-	-	-	-	-	-	-	-	-
MXST009	3m x 3m upholstered ceiling with ventilation/ Plafond en tissu avec aération 3m x 3m/ Stoffdecke inkl. Belüftung 3 mt x 3 mt	-	-	-	-	10892	-	-	-	-	-	-	-	-	-	-	-	-	-
MXSM010	3m x 3m solid ceiling without ventilation/ Plafond en panneau sans aération 3m x 3m/ Melamindecke ohne Belüftung 3 mt x 3 mt	-	-	-	-	4869	-	-	-	-	-	-	-	-	-	-	-	-	-
MXST010	3m x 3m upholstered ceiling without ventilation/ Plafond en tissu sans aération 3m x 3m/ Stoffdecke ohne Belüftung 3 mt x 3 mt	-	-	-	-	6859	-	-	-	-	-	-	-	-	-	-	-	-	-

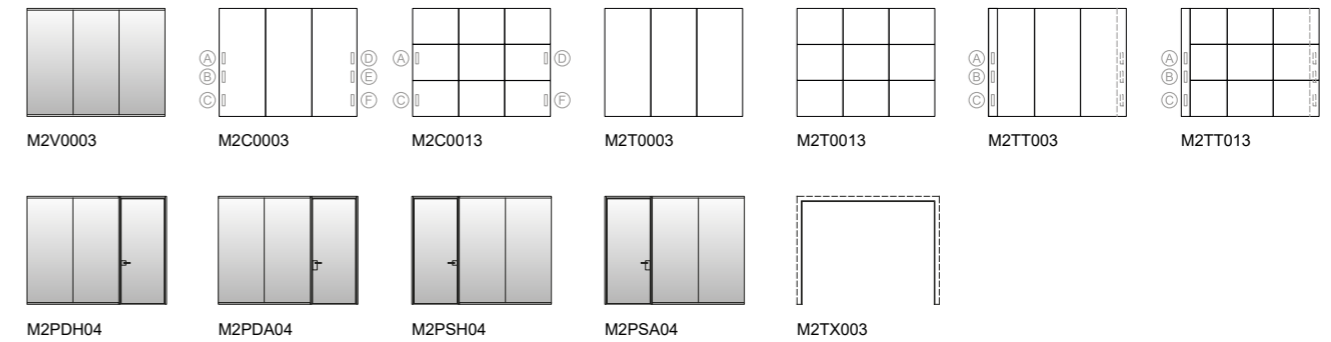

PLEASE NOTE: at least one solid wall panel is mandatory
ATTENTION: Un côté plein toujours obligatoire
WARNUNG: Eine geschlossene Wandstrecke ist immer erforderlich

1	2	3	4	5	Frosted glass		Tracks in anthracite		Tracks in RAL of your choice		Lacquered solid wall (1 side)		Wood veneer solid wall (1 side)		Power modules / Multiprises / Mehrfachsteckdosen			
					Verre dépoli	Satiniertes Glas	Profilis gris ombre	Profilis Dunkelgrau	Profilis RAL au choix	Profilis nach RAL Farbkarte	Panneau RAL (1 côté)	Panneau lackiert (einseitig)	Panneau mélamin (1 côté)	Holzpaneel (einseitig)	S	L	S	L
					+813	+225	+469	-	-	-	-	-	-	-	-	-	-	-
					-	+112	+331	+804	+3292	+348	+400	+395	+447					
					-	+112	+331	+823	+3311	+348	+400	+395	+447					
					-	+112	+331	-	-	-	-	-	-	-	-	-	-	-
					-	+112	+331	-	-	+369	+421	+416	+468					
					-	+112	+331	-	-	+369	+421	+416	+468					
					+752	+243	+602	-	-	-	-	-	-	-	-	-	-	-
					+752	+243	+602	-	-	-	-	-	-	-	-	-	-	-
					-	+145	+425	-	-	-	-	-	-	-	-	-	-	-
					-	-	-	-	-	-	-	-	-	-	-	-	-	-
					-	-	-	-	-	-	-	-	-	-	-	-	-	-
					-	-	-	-	-	-	-	-	-	-	-	-	-	-

XChange

M2 - 3x3

3x3 acoustic booth - middle door

Cabine acoustique 3x3- porte centrale
Akustikkabine 3 mt x 3 mt - mittige Tür

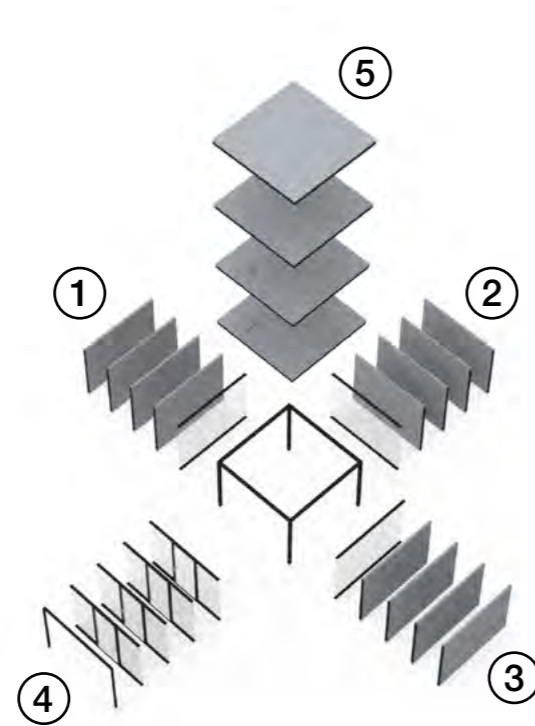
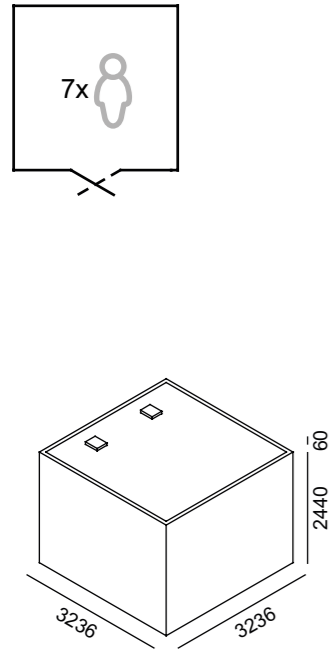

Cod. PBM22011

Code	Description
M2V0003	3m double glazed wall/ Section vitrée 3m double vitrage/ Wandstrecke 3 mt mit Doppelglas
M2C0003	3m solid wall/ Section panneau 3m vertical/ Geschlossene Melaminwandstrecke 3 mt breit vertikal
M2C0013	3m tiled solid wall/ Section panneau 3m horizontal/ Geschlossene Melaminwandstrecke 3 mt breit horizontal
M2T0003	3m solid wall, inner upholstery/ Section tissu 3m vertical/ Stoffwandstrecke 3 mt vertikal
M2T0013	3m tiled solid wall, inner upholstery/ Section tissu 3m horizontal/ Stoffwandstrecke 3 mt horizontal
M2TT003	3m solid wall, switch post, inner upholstery/ Section tissu 3m vertical avec module technique/ Stoffwandstrecke 3 mt vertikal mit Technikmodul
M2TT013	3m tiled solid wall, switch post, inner upholstery/ Section tissu 3m horizontal avec module technique/ Stoffwandstrecke 3 mt horizontal mit Technikmodul
M2PDH05	3m wall with middle RH door, HCS handle/ Section porte tirant droite, poignée HCS, 3m centrale/ Wandstrecke 3 mt mit mittiger rechten Tür Griff HCS
M2PDA05	3m wall with middle RH door, AGB handle/ Section porte tirant droite, poignée AGB, 3m centrale/ Wandstrecke 3 mt mit mittiger rechten Tür Griff AGB
M2PSH05	3m wall with middle LH door, HCS handle/ Section porte tirant gauche, poignée HCS, 3m centrale/ Wandstrecke 3 mt mit mittiger linken Tür Griff HCS
M2PSA05	3m wall with middle LH door, AGB handle/ Section porte tirant gauche, poignée AGB, 3m centrale/ Wandstrecke 3 mt mit mittiger linken Tür Griff AGB
M2TX003	3m open side/ Section ouverte 3m/ Offene Wandstrecke 3 Mt breit
MXSM009	3m x 3m solid ceiling with ventilation/ Plafond en panneau avec aération 3m x 3m/ Melamindecke inkl. Belüftung 3 mt x 3 mt
MXST009	3m x 3m upholstered ceiling with ventilation/ Plafond en tissu avec aération 3m x 3m/ Stoffdecke inkl. Belüftung 3 mt x 3 mt
MXSM010	3m x 3m solid ceiling without ventilation/ Plafond en panneau sans aération 3m x 3m/ Melamindecke ohne Belüftung 3 mt x 3 mt
MXST010	3m x 3m upholstered ceiling without ventilation/ Plafond en tissu sans aération 3m x 3m/ Stoffdecke ohne Belüftung 3 mt x 3 mt

3x3 acoustic booth - middle door

Cabine acoustique 3x3- porte centrale
Akustikkabine 3 mt x 3 mt - mittige Tür

XChange

M2 - 3x3

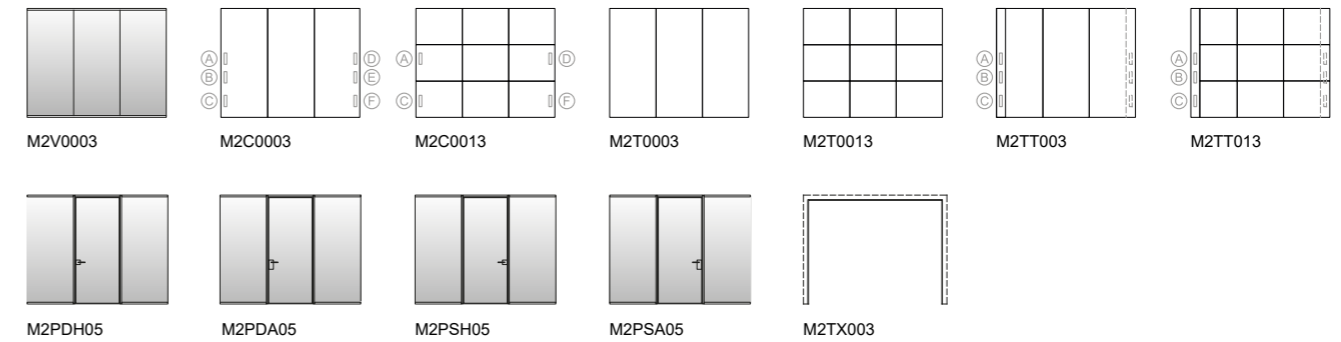

PLEASE NOTE: at least one solid wall panel is mandatory
ATTENTION: Un côté plein toujours obligatoire
WARNUNG: Eine geschlossene Wandstrecke ist immer erforderlich

1 2 3 4 5

	Frosted glass Verre dépoli Satiniertes Glas		Tracks in anthracite Profilis gris ombre Profile Dunkelgrau		Tracks in RAL of your choice Profilis RAL au choix Profile nach RAL Farbkarte		Lacquered solid wall (1 side) Panneau RAL (1 côté) Panneel lackiert (einseitig)		Wood veneer solid wall (1 side) Panneau mélaminé (1 côté) Holzpaneeel (einseitig)		Power modules / Multiprises / Mehrfachsteckdosen			
	S	L	S	L	S	L	S	L	S	L	S	L	S	L
M2V0003	+813	+225	+469	-	-	-	-	-	-	-	-	-	-	-
M2C0003	-	+112	+331	+804	+3292	+348	+400	+395	+447	-	-	-	-	-
M2C0013	-	+112	+331	+823	+3311	+348	+400	+395	+447	-	-	-	-	-
M2T0003	-	+112	+331	-	-	-	-	-	-	-	-	-	-	-
M2T0013	-	+112	+331	-	-	-	-	-	-	-	-	-	-	-
M2TT003	-	+112	+331	-	-	+369	+421	+416	+468	-	-	-	-	-
M2TT013	-	+112	+331	-	-	+369	+421	+416	+468	-	-	-	-	-
M2PDH05	+752	+243	+602	-	-	-	-	-	-	-	-	-	-	-
M2PDA05	+752	+243	+602	-	-	-	-	-	-	-	-	-	-	-
M2PSH05	+752	+243	+602	-	-	-	-	-	-	-	-	-	-	-
M2PSA05	+752	+243	+602	-	-	-	-	-	-	-	-	-	-	-
M2TX003	-	+145	+425	-	-	-	-	-	-	-	-	-	-	-
MXSM009	-	-	-	-	8902	-	-	-	-	-	-	-	-	-
MXST009	-	-	-	-	10892	-	-	-	-	-	-	-	-	-
MXSM010	-	-	-	-	4869	-	-	-	-	-	-	-	-	-
MXST010	-	-	-	-	6859	-	-	-	-	-	-	-	-	-

4x3 acoustic booth - door on 4m wall
 Cabine acoustique 4x3 - porte côté 4 mètres
 Akustikkabine 4 mt x 3 mt - Tür auf 4 mt Seite

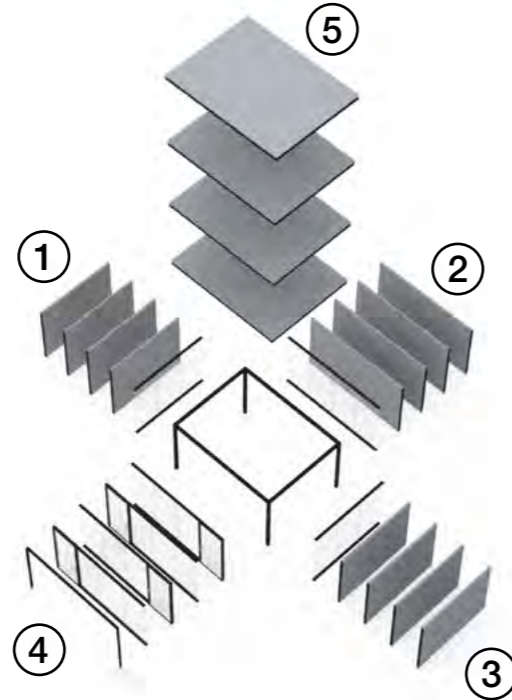
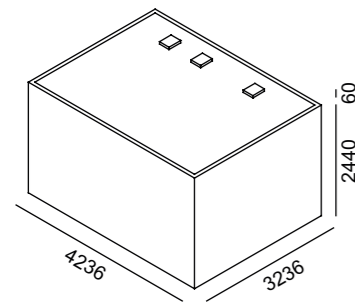
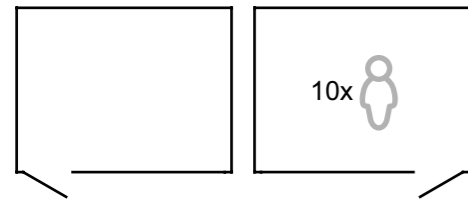

Cod. PBM22012

Code	Description
M2V0003	3m double glazed wall/ Section vitrée 3m double vitrage/ Wandstrecke 3 mt mit Doppelglas
M2V0004	4m double glazed wall/ Section vitrée 4m double vitrage/ Wandstrecke 4 mt mit Doppelglas
M2C0003	3m solid wall/ Section panneau 3m vertical/ Geschlossene Melaminwandstrecke 3 mt breit vertikal
M2C0013	3m tiled solid wall/ Section panneau 3m horizontal/ Geschlossene Melaminwandstrecke 3 mt breit horizontal
M2T0003	3m solid wall, inner upholstery/ Section tissu 3m vertical/ Stoffwandstrecke 3 mt vertikal
M2T0013	3m tiled solid wall, inner upholstery/ Section tissu 3m horizontal/ Stoffwandstrecke 3 mt horizontal
M2TT003	3m solid wall, switch post, inner upholstery/ Section tissu 3m vertical avec module technique/ Stoffwandstrecke 3 mt vertikal mit Technikmodul
M2TT013	3m tiled solid wall, switch post, inner upholstery/ Section tissu 3m horizontal avec module technique/ Stoffwandstrecke 3 mt horizontal mit Technikmodul
M2C0004	4m solid wall/ Section panneau 4m vertical/ Geschlossene Melaminwandstrecke 4 mt breit vertikal
M2C0014	4m tiled solid wall/ Section panneau 4m horizontal/ Geschlossene Melaminwandstrecke 4 mt breit horizontal
M2T0004	4m solid wall, inner upholstery/ Section tissu 4m vertical/ Stoffwandstrecke 4 mt vertikal
M2T0014	4m tiled solid wall, inner upholstery/ Section tissu 4m horizontal/ Stoffwandstrecke 4 mt horizontal
M2TT004	4m solid wall, switch post, inner upholstery/ Section tissu 4m vertical avec module technique/ Stoffwandstrecke 4 mt vertikal mit Technikmodul
M2TT014	4m tiled solid wall, switch post, inner upholstery/ Section tissu 4m horizontal avec module technique/ Stoffwandstrecke 4 mt horizontal mit Technikmodul
M2PDH06	4m glazed RH door, HCS handle/ Section porte tirant droite, poignée HCS, 4m/ Wandstrecke 4 mt mit rechter Tür Griff HCS
M2PDA06	4m glazed RH door, AGB handle/ Section porte tirant droite, poignée AGB, 4m/ Wandstrecke 4 mt mit rechter Tür Griff AGB
M2PSH06	4m glazed LH door, HCS handle/ Section porte tirant gauche, poignée HCS, 4m/ Wandstrecke 4 mt mit linker Tür Griff HCS
M2PSA06	4m glazed LH door, AGB handle/ Section porte tirant gauche, poignée AGB, 4m/ Wandstrecke 4 mt mit linker Tür Griff AGB
M2TX004	4m open side/ Section ouverte 4m/ Offene Wandstrecke 4 Mt breit
MXSM011	4m x 3m solid ceiling with ventilation/ Plafond en panneau avec aération 4m x 3m/ Melamindecke inkl. Belüftung 4 mt x 3 mt
MXST011	4m x 3m upholstered ceiling with ventilation/ Plafond en tissu avec aération 4m x 3m/ Stoffdecke inkl. Belüftung 4 mt x 3 mt
MXSM012	4m x 3m solid ceiling without ventilation/ Plafond en panneau sans aération 4m x 3m/ Melamindecke ohne Belüftung 4 mt x 3 mt
MXST012	4m x 3m upholstered ceiling without ventilation/ Plafond en tissu sans aération 4m x 3m/ Stoffdecke ohne Belüftung 4 mt x 3 mt

4x3 acoustic booth - door on 4m wall
 Cabine acoustique 4x3 - porte côté 4 mètres
 Akustikkabine 4 mt x 3 mt - Tür auf 4 mt Seite

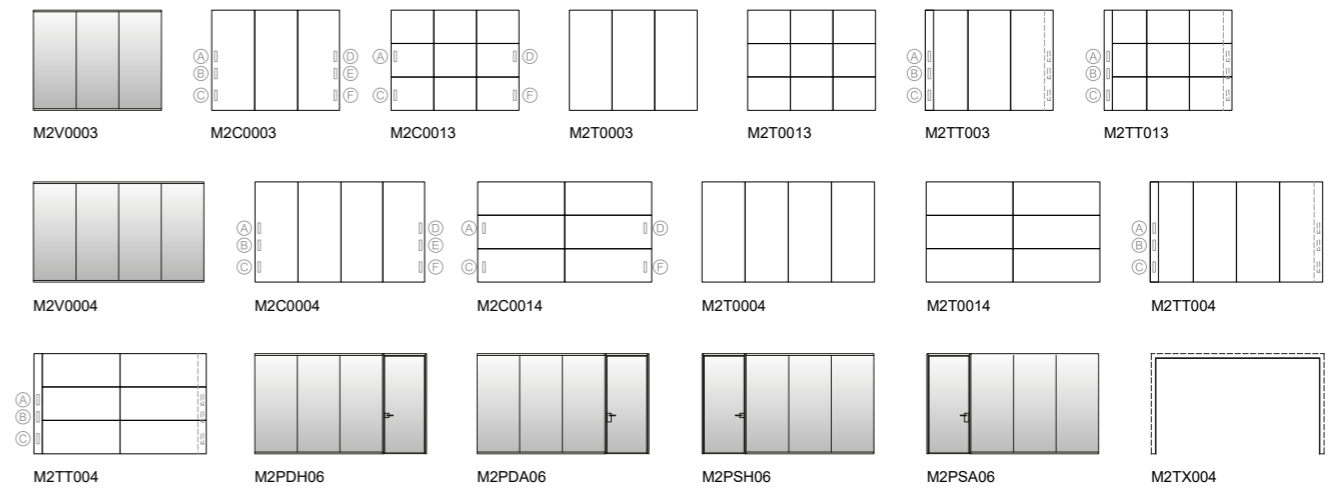

PLEASE NOTE: at least one solid wall panel is mandatory
 ATTENTION: Un côté plein toujours obligatoire
 WARNUNG: Eine geschlossene Wandstrecke ist immer erforderlich

					Frosted glass Verre dépoli Satiniertes Glas			Tracks in anthracite Profilis gris ombre Profilie Dunkelgrau		Tracks in RAL of your choice Profilis RAL au choix Profile nach RAL Farbkarte		Lacquered solid wall (1 side) Panneau RAL (1 côté) Panneel lackiert (einseitig)		Wood veneer solid wall (1 side) Panneau mélamin (1 côté) Holzpaneel (einseitig)		Power modules / Multiprises / Mehrfachsteckdosen			
1	2	3	4	5	S	L	S	L	S	L	S	L	S	L	S	L	S	L	
4670	-	4670	-	-	+813	+225	+469	-	-	-	-	-	-	-	-	-	-	-	
-	6095	-	-	-	+1084	+235	+501	-	-	-	-	-	-	-	-	-	-	-	
1788	-	1788	-	-	-	+112	+331	+804	+3292	+348	+400	+395	+447	-	-	-	-	-	
1977	-	1977	-	-	-	+112	+331	+823	+3311	+348	+400	+395	+447	-	-	-	-	-	
3421	-	3421	-	-	-	+112	+331	-	-	-	-	-	-	-	-	-	-	-	
5468	-	5468	-	-	-	+112	+331	-	-	-	-	-	-	-	-	-	-	-	
3726	-	3726	-	-	-	+112	+331	-	-	+369	+421	+416	+468	-	-	-	-	-	
5773	-	5773	-	-	-	+112	+331	-	-	+369	+421	+416	+468	-	-	-	-	-	
-	2182	-	-	-	-	+123	+362	+1073	+4389	+348	+400	+395	+447	-	-	-	-	-	
-	2581	-	-	-	-	+123	+362	+1098	+4414	+348	+400	+395	+447	-	-	-	-	-	
-	4360	-	-	-	-	+123	+362	-	-	-	-	-	-	-	-	-	-	-	
-	5797	-	-	-	-	+123	+362	-	-	-	-	-	-	-	-	-	-	-	
-	4664	-	-	-	-	+123	+362	-	-	+369	+421	+416	+468	-	-	-	-	-	
-	6102	-	-	-	-	+123	+362	-	-	+369	+421	+416	+468	-	-	-	-	-	
-	-	-	6834	-	+1023	+296	+759	-	-	-	-	-	-	-	-	-	-	-	
-	-	-	6834	-	+1023	+296	+759	-	-	-	-	-	-	-	-	-	-	-	
-	-	-	6834	-	+1023	+296	+759	-	-	-	-	-	-	-	-	-	-	-	
-	-	-	6834	-	+1023	+296	+759	-	-	-	-	-	-	-	-	-	-	-	
-	-	-	167	-	-	+166	+488	-	-	-	-	-	-	-	-	-	-	-	
-	-	-	-	11721	-	-	-	-	-	-	-	-	-	-	-	-	-	-	
-	-	-	-	14373	-	-	-	-	-	-	-	-	-	-	-	-	-	-	
-	-	-	-	5931	-	-	-	-	-	-	-	-	-	-	-	-	-	-	
-	-	-	-	8584	-	-	-	-	-	-	-	-	-	-	-	-	-	-	

4x3 acoustic booth - door in the middle of 4m wall
 Cabine acoustique 4x3 - porte côté 4 mètres centrale
 Akustikkabine 4 mt x 3 mt - mittige Tür auf 4 mt Seite

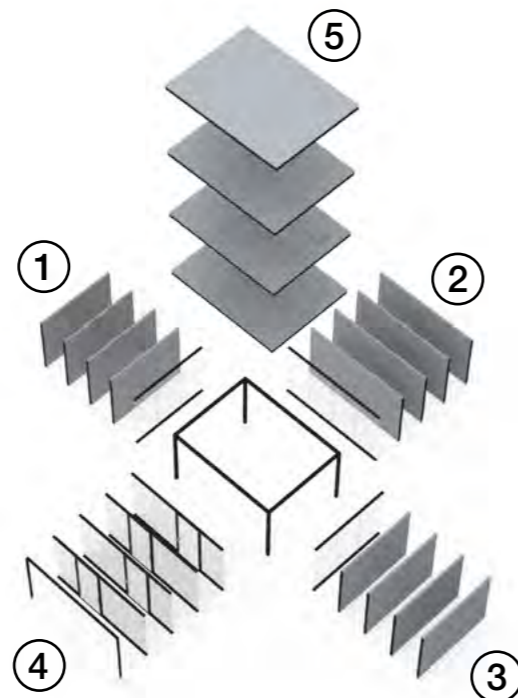
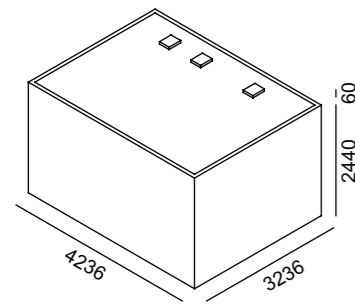
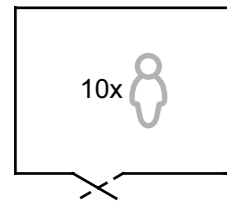

Cod. PBM22013

Cod.	Description	Configuration					Glass & Profiles			Power modules / Multiprises / Mehrfachsteckdosen						
		1	2	3	4	5	Frosted glass Verre dépoli Satiniertes Glas	Tracks in anthracite Profilis gris ombre Profilie Dunkelgrau	Tracks in RAL of your choice Profilis RAL au choix Profile nach RAL Farbkarte	Lacquered solid wall (1 side) Panneau RAL (1 côté) Panneel lackiert (einseitig)	Wood veneer solid wall (1 side) Panneau mélamin (1 côté) Holzpaneel (einseitig)	EU (type F) S L		UK (type G) USA (type A) S L		
M2V0003	3m double glazed wall/ Section vitrée 3m double vitrage/ Wandstrecke 3 mt mit Doppelglas	4670	-	4670	-	-	+813	+225	+469	-	-	-	-	-	-	-
M2V0004	4m double glazed wall/ Section vitrée 4m double vitrage/ Wandstrecke 4 mt mit Doppelglas	-	6095	-	-	-	+1084	+235	+501	-	-	-	-	-	-	-
M2C0003	3m solid wall/ Section panneau 3m vertical/ Geschlossene Melaminwandstrecke 3 mt breit vertikal	1788	-	1788	-	-	-	+112	+331	+804	+3292	+348	+400	+395	+447	-
M2C0013	3m tiled solid wall/ Section panneau 3m horizontal/ Geschlossene Melaminwandstrecke 3 mt breit horizontal	1977	-	1977	-	-	-	+112	+331	+823	+3311	+348	+400	+395	+447	-
M2T0003	3m solid wall, inner upholstery/ Section tissu 3m vertical/ Stoffwandstrecke 3 mt vertikal	3421	-	3421	-	-	-	+112	+331	-	-	-	-	-	-	-
M2T0013	3m tiled solid wall, inner upholstery/ Section tissu 3m horizontal/ Stoffwandstrecke 3 mt horizontal	5468	-	5468	-	-	-	+112	+331	-	-	-	-	-	-	-
M2TT003	3m solid wall, switch post, inner upholstery/ Section tissu 3m vertical avec module technique/ Stoffwandstrecke 3 mt vertikal mit Technikmodul	3726	-	3726	-	-	-	+112	+331	-	-	+369	+421	+416	+468	-
M2TT013	3m tiled solid wall, switch post, inner upholstery/ Section tissu 3m horizontal avec module technique/ Stoffwandstrecke 3 mt horizontal mit Technikmodul	5773	-	5773	-	-	-	+112	+331	-	-	+369	+421	+416	+468	-
M2C0004	4m solid wall/ Section panneau 4m vertical/ Geschlossene Melaminwandstrecke 4 mt breit vertikal	-	2182	-	-	-	-	+123	+362	+1073	+4389	+348	+400	+395	+447	-
M2C0014	4m tiled solid wall/ Section panneau 4m horizontal/ Geschlossene Melaminwandstrecke 4 mt breit horizontal	-	2581	-	-	-	-	+123	+362	+1098	+4414	+348	+400	+395	+447	-
M2T0004	4m solid wall, inner upholstery/ Section tissu 4m vertical/ Stoffwandstrecke 4 mt vertikal	-	4360	-	-	-	-	+123	+362	-	-	-	-	-	-	-
M2T0014	4m tiled solid wall, inner upholstery/ Section tissu 4m horizontal/ Stoffwandstrecke 4 mt horizontal	-	5797	-	-	-	-	+123	+362	-	-	-	-	-	-	-
M2TT004	4m solid wall, switch post, inner upholstery/ Section tissu 4m vertical avec module technique/ Stoffwandstrecke 4 mt vertikal mit Technikmodul	-	4664	-	-	-	-	+123	+362	-	-	+369	+421	+416	+468	-
M2TT014	4m tiled solid wall, switch post, inner upholstery/ Section tissu 4m horizontal avec module technique/ Stoffwandstrecke 4 mt horizontal mit Technikmodul	-	6102	-	-	-	-	+123	+362	-	-	+369	+421	+416	+468	-
M2PDH07	4m wall with middle RH door, HCS handle/ Section porte tirant droite, poignée HCS, 4m centrale/ Wandstrecke 4 mt mit mittiger rechten Tür Griff HCS	-	-	-	6970	-	+1023	+296	+759	-	-	-	-	-	-	-
M2PDA07	4m wall with middle RH door, AGB handle/ Section porte tirant droite, poignée AGB, 4m centrale/ Wandstrecke 4 mt mit mittiger rechten Tür Griff AGB	-	-	-	6970	-	+1023	+296	+759	-	-	-	-	-	-	-
M2PSH07	4m wall with middle LH door, HCS handle/ Section porte tirant gauche, poignée HCS, 4m centrale/ Wandstrecke 4 mt mit mittiger linken Tür Griff HCS	-	-	-	6970	-	+1023	+296	+759	-	-	-	-	-	-	-
M2PSA07	4m wall with middle LH door, AGB handle/ Section porte tirant gauche, poignée AGB, 4m centrale/ Wandstrecke 4 mt mit mittiger linken Tür Griff AGB	-	-	-	6970	-	+1023	+296	+759	-	-	-	-	-	-	-
M2TX004	4m open side/ Section ouverte 4m/ Offene Wandstrecke 4 Mt breit	-	-	-	167	-	-	+166	+488	-	-	-	-	-	-	-
MXSM011	4m x 3m solid ceiling with ventilation/ Plafond en panneau avec aération 4m x 3m/ Melamindecke inkl. Belüftung 4 mt x 3 mt	-	-	-	-	11721	-	-	-	-	-	-	-	-	-	-
MXST011	4m x 3m upholstered ceiling with ventilation/ Plafond en tissu avec aération 4m x 3m/ Stoffdecke inkl. Belüftung 4 mt x 3 mt	-	-	-	-	14373	-	-	-	-	-	-	-	-	-	-
MXSM012	4m x 3m solid ceiling without ventilation/ Plafond en panneau sans aération 4m x 3m/ Melamindecke ohne Belüftung 4 mt x 3 mt	-	-	-	-	5931	-	-	-	-	-	-	-	-	-	-
MXST012	4m x 3m upholstered ceiling without ventilation/ Plafond en tissu sans aération 4m x 3m/ Stoffdecke ohne Belüftung 4 mt x 3 mt	-	-	-	-	8584	-	-	-	-	-	-	-	-	-	-

4x3 acoustic booth - door in the middle of 4m wall
 Cabine acoustique 4x3 - porte côté 4 mètres centrale
 Akustikkabine 4 mt x 3 mt - mittige Tür auf 4 mt Seite

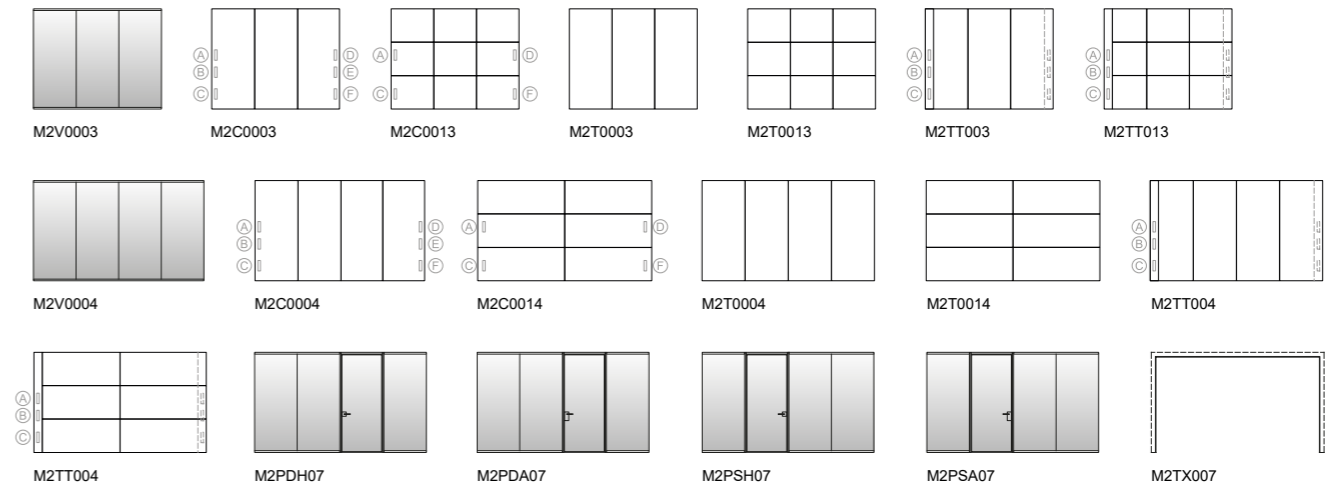

PLEASE NOTE: at least one solid wall panel is mandatory
 ATTENTION: Un côté plein toujours obligatoire
 WARNUNG: Eine geschlossene Wandstrecke ist immer erforderlich

1	2	3	4	5	Frosted glass Verre dépoli Satiniertes Glas	Tracks in anthracite Profilis gris ombre Profilie Dunkelgrau	Tracks in RAL of your choice Profilis RAL au choix Profile nach RAL Farbkarte	Lacquered solid wall (1 side) Panneau RAL (1 côté) Panneel lackiert (einseitig)	Wood veneer solid wall (1 side) Panneau mélamin (1 côté) Holzpaneel (einseitig)	Power modules / Multiprises / Mehrfachsteckdosen			
										EU (type F) S L		UK (type G) USA (type A) S L	

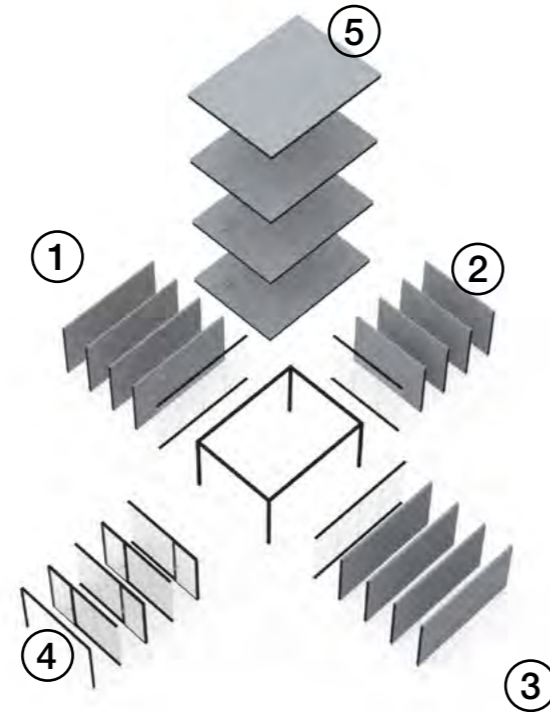
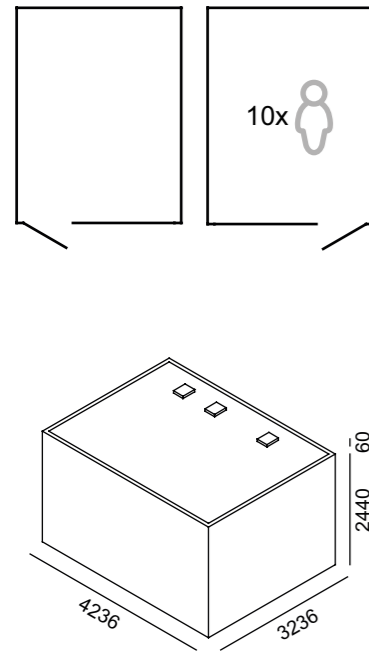

Cod. PBM22014

Code	Description	Configuration					Frosted glass Verre dépoli Satiniertes Glas	Tracks in anthracite Profilis gris ombre Profilie Dunkelgrau	Tracks in RAL of your choice Profilis RAL au choix Profile nach RAL Farbkarte	Lacquered solid wall (1 side) Panneau RAL (1 côté) Panneel lackiert (einseitig)	Wood veneer solid wall (1 side) Panneau mélamin (1 côté) Holzpaneel (einseitig)	Power modules / Multiprises / Mehrfachsteckdosen			
		1	2	3	4	5						EU (type F) S L		UK (type G) USA (type A) S L	
M2V0003	3m double glazed wall/ Section vitrée 3m double vitrage/ Wandstrecke 3 mt mit Doppelglas	-	4670	-	-	-	+813	+225	+469	-	-	-	-	-	-
M2V0004	4m double glazed wall/ Section vitrée 4m double vitrage/ Wandstrecke 4 mt mit Doppelglas	6095	-	6095	-	-	+1084	+235	+501	-	-	-	-	-	-
M2C0003	3m solid wall/ Section panneau 3m vertical/ Geschlossene Melaminwandstrecke 3 mt breit vertikal	-	1788	-	-	-	-	+112	+331	+804	+3292	+348	+400	+395	+447
M2C0013	3m tiled solid wall/ Section panneau 3m horizontal/ Geschlossene Melaminwandstrecke 3 mt breit horizontal	-	1977	-	-	-	-	+112	+331	+823	+3311	+348	+400	+395	+447
M2T0003	3m solid wall, inner upholstery/ Section tissu 3m vertical/ Stoffwandstrecke 3 mt vertikal	-	3421	-	-	-	-	+112	+331	-	-	-	-	-	-
M2T0013	3m tiled solid wall, inner upholstery/ Section tissu 3m horizontal/ Stoffwandstrecke 3 mt horizontal	-	5468	-	-	-	-	+112	+331	-	-	-	-	-	-
M2TT003	3m solid wall, switch post, inner upholstery/ Section tissu 3m vertical avec module technique/ Stoffwandstrecke 3 mt vertikal mit Technikmodul	-	3726	-	-	-	-	+112	+331	-	-	+369	+421	+416	+468
M2TT013	3m tiled solid wall, switch post, inner upholstery/ Section tissu 3m horizontal avec module technique/ Stoffwandstrecke 3 mt horizontal mit Technikmodul	-	5773	-	-	-	-	+112	+331	-	-	+369	+421	+416	+468
M2C0004	4m solid wall/ Section panneau 4m vertical/ Geschlossene Melaminwandstrecke 4 mt breit vertikal	2182	-	2182	-	-	-	+123	+362	+1073	+4389	+348	+400	+395	+447
M2C0014	4m tiled solid wall/ Section panneau 4m horizontal/ Geschlossene Melaminwandstrecke 4 mt breit horizontal	2581	-	2581	-	-	-	+123	+362	+1098	+4414	+348	+400	+395	+447
M2T0004	4m solid wall, inner upholstery/ Section tissu 4m vertical/ Stoffwandstrecke 4 mt vertikal	4360	-	4360	-	-	-	+123	+362	-	-	-	-	-	-
M2T0014	4m tiled solid wall, inner upholstery/ Section tissu 4m horizontal/ Stoffwandstrecke 4 mt horizontal	5797	-	5797	-	-	-	+123	+362	-	-	-	-	-	-
M2TT004	4m solid wall, switch post, inner upholstery/ Section tissu 4m vertical avec module technique/ Stoffwandstrecke 4 mt vertikal mit Technikmodul	4664	-	4664	-	-	-	+123	+362	-	-	+369	+421	+416	+468
M2TT014	4m tiled solid wall, switch post, inner upholstery/ Section tissu 4m horizontal avec module technique/ Stoffwandstrecke 4 mt horizontal mit Technikmodul	6102	-	6102	-	-	-	+123	+362	-	-	+369	+421	+416	+468
M2PDH04	3m glazed RH door, HCS handle/ Section porte tirant droite, poignée HCS, 3m/ Wandstrecke 3 mt mit rechter Tür Griff HCS	-	-	-	5409	-	+752	+243	+602	-	-	-	-	-	-
M2PDA04	3m glazed RH door, AGB handle/ Section porte tirant droite, poignée AGB, 3m/ Wandstrecke 3 mt mit rechter Tür Griff AGB	-	-	-	5409	-	+752	+243	+602	-	-	-	-	-	-
M2PSH04	3m glazed LH door, HCS handle/ Section porte tirant gauche, poignée HCS, 3m/ Wandstrecke 3 mt mit linker Tür Griff HCS	-	-	-	5409	-	+752	+243	+602	-	-	-	-	-	-
M2PSA04	3m glazed LH door, AGB handle/ Section porte tirant gauche, poignée AGB, 3m/ Wandstrecke 3 mt mit linker Tür Griff AGB	-	-	-	5409	-	+752	+243	+602	-	-	-	-	-	-
M2TX003	3m open side/ Section ouverte 3m/ Offene Wandstrecke 3 Mt breit	-	-	-	164	-	-	+145	+425	-	-	-	-	-	-
MXSM011	4m x 3m solid ceiling with ventilation/ Plafond en panneau avec aération 4m x 3m/ Melamindecke inkl. Belüftung 4 mt x 3 mt	-	-	-	-	11721	-	-	-	-	-	-	-	-	-
MXST011	4m x 3m upholstered ceiling with ventilation/ Plafond en tissu avec aération 4m x 3m/ Stoffdecke inkl. Belüftung 4 mt x 3 mt	-	-	-	-	14373	-	-	-	-	-	-	-	-	-
MXSM012	4m x 3m solid ceiling without ventilation/ Plafond en panneau sans aération 4m x 3m/ Melamindecke ohne Belüftung 4 mt x 3 mt	-	-	-	-	5931	-	-	-	-	-	-	-	-	-
MXST012	4m x 3m upholstered ceiling without ventilation/ Plafond en tissu sans aération 4m x 3m/ Stoffdecke ohne Belüftung 4 mt x 3 mt	-	-	-	-	8584	-	-	-	-	-	-	-	-	-

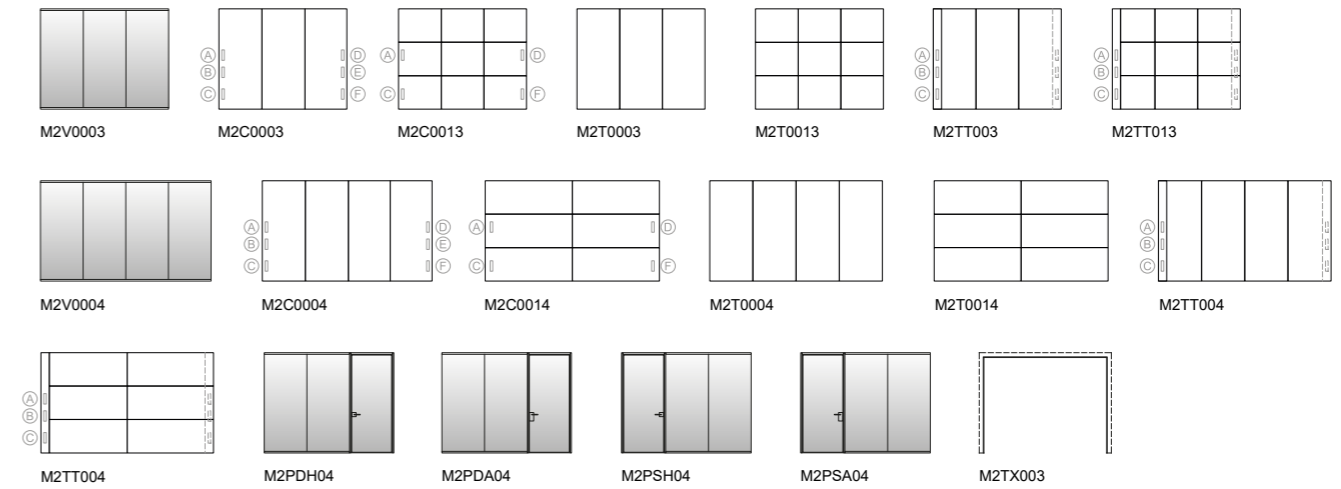

PLEASE NOTE: at least one solid wall panel is mandatory
 ATTENTION: Un côté plein toujours obligatoire
 WARNUNG: Eine geschlossene Wandstrecke ist immer erforderlich

1 2 3 4 5

Frosted glass
Verre dépoli
Satiniertes Glas

Tracks in anthracite
Profilis gris ombre
Profilie Dunkelgrau

Tracks in RAL of your choice
Profilis RAL au choix
Profile nach RAL Farbkarte

Lacquered solid wall (1 side)
Panneau RAL (1 côté)
Panneel lackiert (einseitig)

Wood veneer solid wall (1 side)
Panneau mélamin (1 côté)
Holzpaneel (einseitig)

**Power modules / Multiprises /
Mehrfachsteckdosen**

EU (type F)
S L

**UK (type G)
USA (type A)**
S L

3x4 acoustic booth - door in the middle of 3m wall
 Cabine acoustique 3x4 - porte côté 3 mètres centrale
 Akustikkabine 4 mt x 3 mt - mittige Tür auf 3 mt Seite

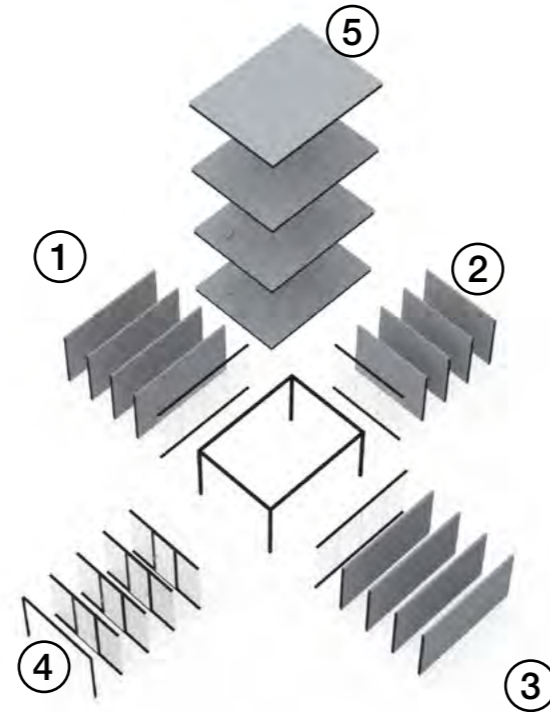
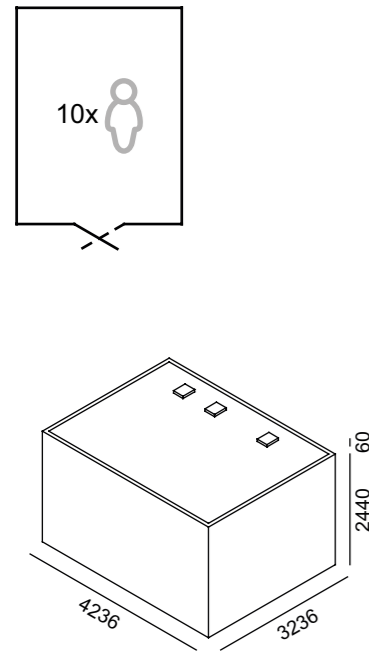

Cod. PBM22015

Code	Description	Configuration					Glass & Profiles			Lacquered solid wall (1 side)		Wood veneer solid wall (1 side)		Power modules / Multiprises / Mehrfachsteckdosen			
		1	2	3	4	5	Frosted glass	Tracks in anthracite	Tracks in RAL of your choice	Panel	Panel	EU (type F)	UK (type G)	S	L	S	L
M2V0003	3m double glazed wall/ Section vitrée 3m double vitrage/ Wandstrecke 3 mt mit Doppelglas	-	4670	-	-	-	+813	+225	+469	-	-	-	-	-	-	-	-
M2V0004	4m double glazed wall/ Section vitrée 4m double vitrage/ Wandstrecke 4 mt mit Doppelglas	6095	-	6095	-	-	+1084	+235	+501	-	-	-	-	-	-	-	-
M2C0003	3m solid wall/ Section panneau 3m vertical/ Geschlossene Melaminwandstrecke 3 mt breit vertikal	-	1788	-	-	-	-	+112	+331	+804	+3292	+348	+400	+395	+447	-	-
M2C0013	3m tiled solid wall/ Section panneau 3m horizontal/ Geschlossene Melaminwandstrecke 3 mt breit horizontal	-	1977	-	-	-	-	+112	+331	+823	+3311	+348	+400	+395	+447	-	-
M2T0003	3m solid wall, inner upholstery/ Section tissu 3m vertical/ Stoffwandstrecke 3 mt vertikal	-	3421	-	-	-	-	+112	+331	-	-	-	-	-	-	-	-
M2T0013	3m tiled solid wall, inner upholstery/ Section tissu 3m horizontal/ Stoffwandstrecke 3 mt horizontal	-	5468	-	-	-	-	+112	+331	-	-	-	-	-	-	-	-
M2TT003	3m solid wall, switch post, inner upholstery/ Section tissu 3m vertical avec module technique/ Stoffwandstrecke 3 mt vertikal mit Technikmodul	-	3726	-	-	-	-	+112	+331	-	-	+369	+421	+416	+468	-	-
M2TT013	3m tiled solid wall, switch post, inner upholstery/ Section tissu 3m horizontal avec module technique/ Stoffwandstrecke 3 mt horizontal mit Technikmodul	-	5773	-	-	-	-	+112	+331	-	-	+369	+421	+416	+468	-	-
M2C0004	4m solid wall/ Section panneau 4m vertical/ Geschlossene Melaminwandstrecke 4 mt breit vertikal	2182	-	2182	-	-	-	+123	+362	+1073	+4389	+348	+400	+395	+447	-	-
M2C0014	4m tiled solid wall/ Section panneau 4m horizontal/ Geschlossene Melaminwandstrecke 4 mt breit horizontal	2581	-	2581	-	-	-	+123	+362	+1098	+4414	+348	+400	+395	+447	-	-
M2T0004	4m solid wall, inner upholstery/ Section tissu 4m vertical/ Stoffwandstrecke 4 mt vertikal	4360	-	4360	-	-	-	+123	+362	-	-	-	-	-	-	-	-
M2T0014	4m tiled solid wall, inner upholstery/ Section tissu 4m horizontal/ Stoffwandstrecke 4 mt horizontal	5797	-	5797	-	-	-	+123	+362	-	-	-	-	-	-	-	-
M2TT004	4m solid wall, switch post, inner upholstery/ Section tissu 4m vertical avec module technique/ Stoffwandstrecke 4 mt vertikal mit Technikmodul	4664	-	4664	-	-	-	+123	+362	-	-	+369	+421	+416	+468	-	-
M2TT014	4m tiled solid wall, switch post, inner upholstery/ Section tissu 4m horizontal avec module technique/ Stoffwandstrecke 4 mt horizontal mit Technikmodul	6102	-	6102	-	-	-	+123	+362	-	-	+369	+421	+416	+468	-	-
M2PDH05	3m wall with middle RH door, HCS handle/ Section porte tirant droite, poignée HCS, 3m centrale/ Wandstrecke 3 mt mit mittiger rechten Tür Griff HCS	-	-	-	5492	-	+752	+243	+602	-	-	-	-	-	-	-	-
M2PDA05	3m wall with middle RH door, AGB handle/ Section porte tirant droite, poignée AGB, 3m centrale/ Wandstrecke 3 mt mit mittiger rechten Tür Griff AGB	-	-	-	5492	-	+752	+243	+602	-	-	-	-	-	-	-	-
M2PSH05	3m wall with middle LH door, HCS handle/ Section porte tirant gauche, poignée HCS, 3m centrale/ Wandstrecke 3 mt mit mittiger linken Tür Griff HCS	-	-	-	5492	-	+752	+243	+602	-	-	-	-	-	-	-	-
M2PSA05	3m wall with middle LH door, AGB handle/ Section porte tirant gauche, poignée AGB, 3m centrale/ Wandstrecke 3 mt mit mittiger linken Tür Griff AGB	-	-	-	5492	-	+752	+243	+602	-	-	-	-	-	-	-	-
M2TX003	3m open side/ Section ouverte 3m/ Offene Wandstrecke 3 Mt breit	-	-	-	164	-	-	+145	+425	-	-	-	-	-	-	-	-
MXSM011	4m x 3m solid ceiling with ventilation/ Plafond en panneau avec aération 4m x 3m/ Melamindecke inkl. Belüftung 4 mt x 3 mt	-	-	-	-	11721	-	-	-	-	-	-	-	-	-	-	-
MXST011	4m x 3m upholstered ceiling with ventilation/ Plafond en tissu avec aération 4m x 3m/ Stoffdecke inkl. Belüftung 4 mt x 3 mt	-	-	-	-	14373	-	-	-	-	-	-	-	-	-	-	-
MXSM012	4m x 3m solid ceiling without ventilation/ Plafond en panneau sans aération 4m x 3m/ Melamindecke ohne Belüftung 4 mt x 3 mt	-	-	-	-	5931	-	-	-	-	-	-	-	-	-	-	-
MXST012	4m x 3m upholstered ceiling without ventilation/ Plafond en tissu sans aération 4m x 3m/ Stoffdecke ohne Belüftung 4 mt x 3 mt	-	-	-	-	8584	-	-	-	-	-	-	-	-	-	-	-

3x4 acoustic booth - door in the middle of 3m wall
 Cabine acoustique 3x4 - porte côté 3 mètres centrale
 Akustikkabine 4 mt x 3 mt - mittige Tür auf 3 mt Seite

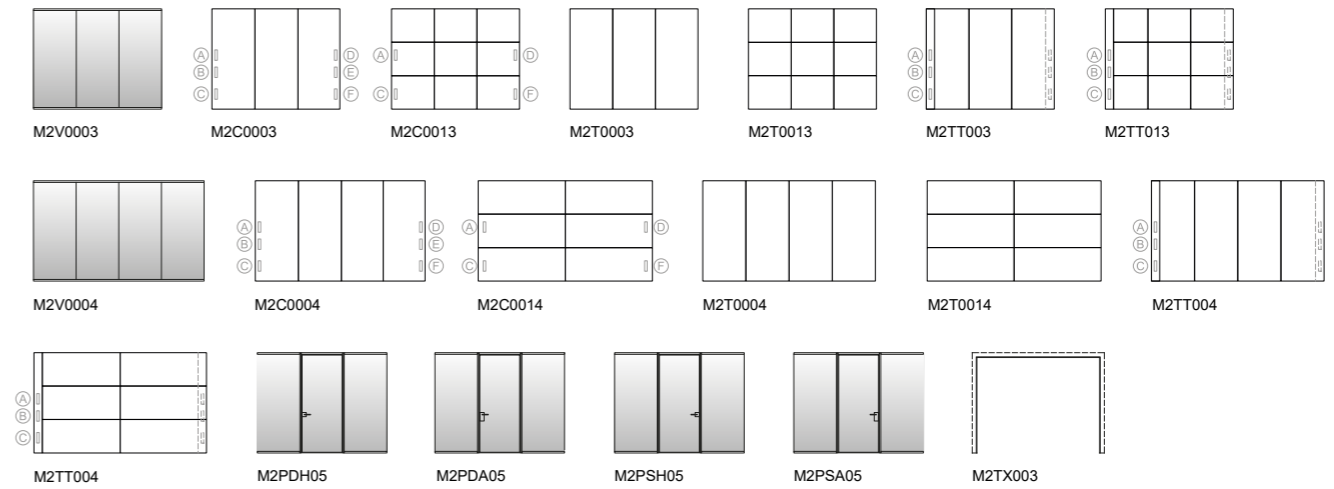

PLEASE NOTE: at least one solid wall panel is mandatory
 ATTENTION: Un côté plein toujours obligatoire
 WARNUNG: Eine geschlossene Wandstrecke ist immer erforderlich

Frosted glass
 Verre dépoli
 Satiniertes Glas

Tracks in anthracite
 Profils gris ombre
 Profile Dunkelgrau

Tracks in RAL of your choice
 Profils RAL au choix
 Profile nach RAL Farbkarte

Lacquered solid wall (1 side)
 Panneau RAL (1 côté)
 Paneel lackiert (einseitig)

Wood veneer solid wall (1 side)
 Panneau mélaminé (1 côté)
 Holzpaneel (einseitig)

Power modules / Multiprises / Mehrfachsteckdosen

EU (type F) UK (type G)
 S L S L

W	D	H	CODE	PRICE	OPTIONS	M ³	KG	PARCELS
L	P	H	REF..	PRIX	OPTIONS	M ³	KG	COLIS
B	T	H	ART. NR.	PREIS	VARIANTEN	M ³	KG	KOLLI

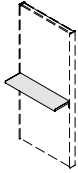

Melamine shelf for fitting to solid wall panels

Etagère pour module plein
Fachboden für geschlossene Module

100	30	3	PBME0001	137	LA + 69	LP +284	0,017	8	1
-----	----	---	----------	------------	-------------------	-------------------	-------	---	---

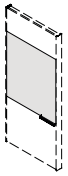

Writable whiteboard - supplied factory fitted to the panel

Film inscriptible collé
Beschreibbare Folie bereit aufgeklebt

125	-	100	PBLA0001	265					
-----	---	-----	----------	------------	--	--	--	--	--

If you wish to order a metal tray with four board pens and one eraser - code PBLA002 - then there is one more upcharge 67 pts
Kit porte-marqueur en tôle d'acier pliée et peinte, 4 marqueurs colorés et une gomme ref. PBLA002, 67 pts
Ausrüstungssatz: Behälter für Filzstifte (aus gebogenem und lackiertem Stahlblech) , 4 farbige Filzstifte und Radiergummi art. nr. PBLA002, 67pts

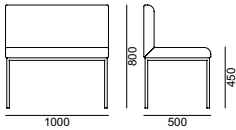

Seating

Banc
Sitzbank

100	50	80	OPANC001	B01/B03	C01/C05	W01/D02	P01	0,360	7	1
				384	404	437	604			