

Shared Spaces



Multi-meeting	182
Flip-top tables	194
Folding tables	197
Modular tables	198
Circular/barrel/oval tables	199
Multi-purpose tables/ Easy access tables	200
Notice boards	202
Catering	208

Multi-meeting

The Multi-meeting collection allows you to create multiple solutions tailor-made to individual requirements.

Prestige tables offer a tangible sense of quality with their traditional solid wood veneers, an opportunity to personalise meeting and conference spaces with a touch of refinement and elegance.

The Privilege range and its substantial table tops, presented in light and dark woods, provide for substantial, timeless configurations. Business tables exude contemporary design and are a fitting complement to our System range.



"I decided to fit-out all our meeting rooms with this ingenious range of furniture. It offers innumerable layout options for every space."

THIERRY MARTIN Sales Events & Project Manager



Reaching a **consensus**





Practical and well-thought-out accessories
for efficient cable management



From management board meetings to more intimate collaboration spaces, the MULTI-MEETING range boasts an infinite variety of solutions aimed at facilitating interaction.





Shade card

Prestige: 2 choices of finish for wood veneer tops and panel legs, 29 mm thick

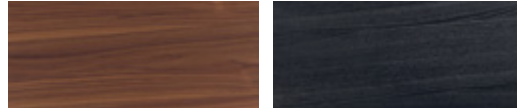

JN
Semi-matt
walnut

JA
Black ash

Privilege: 3 choices of finish for melamine tops and panel legs, 38 mm thick

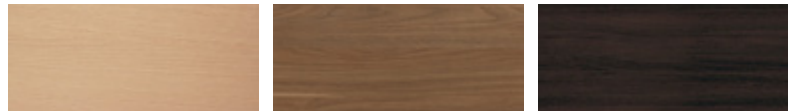

MN
White oak

RL
Amber walnut

ML
Brown oak

Business: 3 choices of finish for melamine tops and panel legs, 30 mm thick



MG
Snow white

RI
Light oak

RH
French Apple

3 choices of finish for metal legs



SO
White

SA
Aluminium grey

SC
Graphite grey

The Range

Rectangular tables



Curved tables

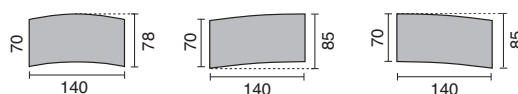

Corner tops

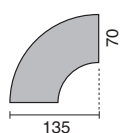

Elliptical tops

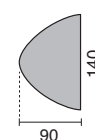

Standards



wood veneer elements only

Privilege and Business ranges

for MN and ML

for MG, RI, RH and RL



1



2



3



4

Technical specifications

8 choices of finish for table tops, with 3 types of leg design:

- Prestige: Wood veneer tops, 29 mm thick. Straight edges covered in 2 mm thick wood veneer edge banding, matching the top finish. Choice of semi-matt or satin varnish. Finish assorted to the Inveo product range.

- Privilege: Melamine counterbalanced high-density particle board, 38 mm thick. 2 mm thick impact-resistant ABS edge banding. Finish assorted to the table tops, as well as the Kara and M38 product ranges.

- Business: Melamine counterbalanced high-density particle board, 30 mm thick. 2 mm thick impact-resistant ABS edge banding. Finish assorted to the tops of the System product range.

1 Melamine or wood veneer panel legs matching the tops. Shared panel legs. Fitted with adjustable stabilizer feet, adjust through 15 mm.

2 Fixed rounded triangular metal legs. Legs feature a decorative trim fold running along the length of the leg on the 2 outer faces. Adjustable stabilizer feet. Fixed metal legs available in standard version or fitted with cable management features. The latter version is equipped with a detachable leg panel on the inner face of the leg.

3 Multiple combinations possible thanks to the 8 different table top shapes and 2 leg designs.

4 Optional metal modesty panels matching the metal legs or made from white finish Altuglas®. Height 24 cm.

5 6 Elliptical design tables can be fitted with an optional cable trough and top access system, either in a metal or black or white Altuglas® finish.

7 Optional built-in power/data socket housing, designed to flip open from the table top. When placing an order, please specify the desired quantity and position of the power centre(s). Contact us for details on pricing.

8 Decorative storage units matching the table top finishes in the Prestige range. For technical specifications, refer to the Inveo product range on p. 242.

9 Traditional storage units matching the table top finishes in the Privilege and Business product ranges. For technical specifications, refer to the Kara product range on p. 256 or melamine storage solutions p. 158.



5 6



7



8



9

Prestige Privilege Business

■ Seats up to 10 people

Oval table W. 320 x D. 140 cm - 2 standard tops W. 140 cm + 2 elliptical tops

Leg type A 6 072 006 + top + top
 Leg type B 6 072 182 + top + leg
 Leg type C - 2 LCM 6 072 196 + top + leg

Elliptical table W. 320 x D. 156 cm - 2 symmetrical curved tops + 2 elliptical tops

Leg type A 6 072 002 + top + top
 Leg type B 6 072 181 + top + leg
 Leg type C - 2 LCM 6 072 195 + top + leg

U-shaped table W. 275 x D. 270 cm - 2 standard tops W. 140 cm + 2 x 90° corner tops W. 135 cm

Leg type A 6 072 175 + top + top
 Leg type B 6 072 213 + top + leg
 Leg type C - 5 LCM 6 072 219 + top + leg

■ Seats up to 12 people

Oval table W. 360 x D. 140 cm - 2 standard tops W. 180 cm + 2 elliptical tops

Leg type A 6 072 234 + top + top
 Leg type B 6 072 235 + top + leg
 Leg type C - 2 LCM 6 072 236 + top + leg

U-shaped table W. 275 x D. 410 cm - 3 standard tops W. 140 cm + 2 x 90° corner tops W. 135 cm

Leg type A 6 072 176 + top + top
 Leg type B 6 072 214 + top + leg
 Leg type C - 6 LCM 6 072 220 + top + leg

U-shaped table W. 315 x D. 270 cm - 2 standard tops W. 180 cm + 2 x 90° corner tops W. 135 cm

Leg type A 6 072 237 + top + top
 Leg type B 6 072 238 + top + leg
 Leg type C - 5 LCM 6 072 239 + top + leg

Circular table W. 270 x D. 270 cm - 4 x 90° corner tops W. 135 cm

Leg type A 6 072 022 + top + top
 Leg type B 6 072 185 + top + leg
 Leg type C - 4 LCM 6 072 199 + top + leg

Square table W. 280 x D. 280 cm - 4 standard tops W. 140 cm + 4 x 90° corner tops

Leg type A 6 072 083 + top + top
 Leg type B 6 072 209 + top + leg
 Leg type C - 8 LCM 6 072 211 + top + leg

Square table W. 296 x D. 296 cm - 4 curved tops + 4 x 90° corner tops

Leg type A 6 072 084 + top + top
 Leg type B 6 072 210 + top + leg
 Leg type C - 8 LCM 6 072 212 + top + leg

■ Seats up to 14 people

Oval table W. 460 x D. 140 cm - 4 standard tops W. 140 cm + 2 elliptical tops

Leg type A 6 072 008 + top + top
 Leg type B 6 072 183 + top + leg
 Leg type C - 2 LCM 6 072 197 + top + leg

Elliptical table W. 460 x D. 170 cm - 4 curved tops + 2 elliptical tops

Leg type A 6 072 040 + top + top
 Leg type B 6 072 189 + top + leg
 Leg type C - 4 LCM 6 072 203 + top + leg

U-shaped table W. 415 x D. 270 cm - 4 standard tops W. 140 cm + 2 x 90° corner tops W. 135 cm

Leg type A 6 072 177 + top + top
 Leg type B 6 072 215 + top + leg
 Leg type C - 7 LCM 6 072 221 + top + leg

Square table W. 320 x D. 320 cm - 4 standard tops W. 180 cm + 4 x 90° corner tops

Leg type A 6 072 240 + top + top
 Leg type B 6 072 241 + top + leg
 Leg type C - 8 LCM 6 072 242 + top + leg

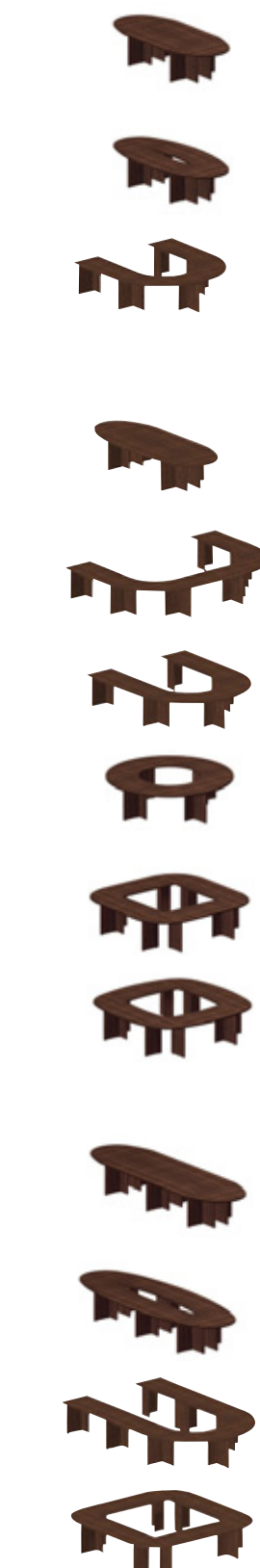

Leg type A = panel leg; Leg type B = fixed metal leg without cable management; Leg type C = fixed metal leg with cable management; LCM = number of legs with cable mgt per configuration

Prestige
 2 choices of finish for wood veneer tops and panel legs (+ top)



Privilege
 3 choices of finish for melamine tops and panel legs (+ top)

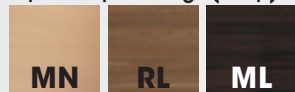

Business
 3 choices of finish for melamine tops and panel legs (+ top)

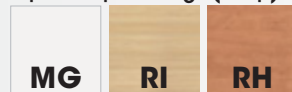

3 choices of finish for metal legs (+ leg)



Prestige

Privilege

Business

■ Seats up to 15 people

U-shaped table W. 315 x D. 450cm - 3 standard tops W. 180 cm + 2 x 90°corner tops W. 135 cm

Leg type A 6 072 243 + top + top
 Leg type B 6 072 244 + top + leg
 Leg type C - 6 LCM 6 072 245 + top + leg



■ Seats up to 16 people

U-shaped table W. 415 x D. 410 cm - 5 standard tops W. 140 cm + 2 x 90°corner tops W. 135 cm

Leg type A 6 072 178 + top + top
 Leg type B 6 072 216 + top + leg
 Leg type C - 8 LCM 6 072 222 + top + leg



■ Seats up to 18 people

Oval table W. 540 x D. 140 cm - 4 standard tops W. 180 cm + 2 elliptical tops

Leg type A 6 072 246 + top + top
 Leg type B 6 072 247 + top + leg
 Leg type C - 2 LCM 6 072 248 + top + leg



Oval table W. 600 x D. 140 cm - 6 standard tops W. 140 cm + 2 elliptical tops

Leg type A 6 072 180 + top + top
 Leg type B 6 072 217 + top + leg
 Leg type C - 4 LCM 6 072 223 + top + leg



Elliptical table W. 600 x D. 170 cm - 4 curved tops + 2 standard tops W. 140 cm + 2 elliptical tops

Leg type A 6 072 044 + top + top
 Leg type B 6 072 190 + top + leg
 Leg type C - 6 LCM 6 072 204 + top + leg



U-shaped table W. 495 x D. 270 cm - 4 standard tops W. 180 cm + 2 x 90°corner tops W. 135 cm

Leg type A 6 072 249 + top + top
 Leg type B 6 072 250 + top + leg
 Leg type C - 7 LCM 6 072 251 + top + leg



U-shaped table W. 555 x D. 270 cm - 6 standard tops W. 140 cm + 2 x 90°corner tops W. 135 cm

Leg type A 6 072 179 + top + top
 Leg type B 6 072 218 + top + leg
 Leg type C - 9 LCM 6 072 224 + top + leg



■ Seats up to 20 people

Elliptical table W. 640 x D. 170 cm - 4 curved tops + 2 standard tops W. 180 cm + 2 elliptical tops

Leg type A 6 072 252 + top + top
 Leg type B 6 072 253 + top + leg
 Leg type C - 6 LCM 6 072 254 + top + leg



Square table W. 410 x D. 410 cm - 4 standard tops W. 140 cm + 4 x 90°corner tops W. 135 cm

Leg type A 6 072 028 + top + top
 Leg type B 6 072 186 + top + leg
 Leg type C - 8 LCM 6 072 200 + top + leg



Square table W. 420 x D. 420 cm - 8 standard tops W. 140 cm + 4 x 90° corner tops

Leg type A 6 072 029 + top + top
 Leg type B 6 072 187 + top + leg
 Leg type C - 4 LCM 6 072 201 + top + leg



Square table W. 452 x D. 452 cm - 8 curved tops + 4 x 90° corner tops

Leg type A 6 072 030 + top + top
 Leg type B 6 072 188 + top + leg
 Leg type C - 4 LCM 6 072 202 + top + leg



■ Seats up to 21 people

U-shaped table W. 495 x D. 450 cm - 5 standard tops W. 180 cm + 2 x 90°corner tops W. 135 cm

Leg type A 6 072 255 + top + top
 Leg type B 6 072 256 + top + leg
 Leg type C - 8 LCM 6 072 257 + top + leg



Leg type A : panel leg



Leg type B : fixed metal leg without cable management



Leg type C : fixed metal leg with cable management

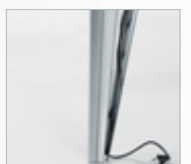

Prestige Privilege Business

■ Seats up to 24 people



U-shaped table W. 675 x D. 270 cm - 6 standard tops W. 180 cm + 2 x 90° corner tops W. 135 cm
 Leg type A 6 072 258 + top + top
 Leg type B 6 072 259 + top + leg
 Leg type C - 9 LCM 6 072 260 + top + leg



Oval table W. 720 x D. 140 cm - 6 standard tops W. 180 cm + 2 elliptical tops
 Leg type A 6 072 264 + top + top
 Leg type B 6 072 265 + top + leg
 Leg type C - 4 LCM 6 072 266 + top + leg



Square table W. 450 x D. 450 cm - 4 standard tops W. 180 cm + 4 x 90° corner tops W. 135 cm
 Leg type A 6 072 261 + top + top
 Leg type B 6 072 262 + top + leg
 Leg type C - 8 LCM 6 072 263 + top + leg



Rectangular table W. 550 x D. 410 cm - 6 standard tops W. 140 cm + 4 x 90° corner tops W. 135 cm
 Leg type A 6 072 066 + top + top
 Leg type B 6 072 191 + top + leg
 Leg type C - 12 LCM 6 072 205 + top + leg



Rectangular table W. 560 x D. 420 cm - 10 standard tops W. 140 cm + 4 x 90° corner units
 Leg type A 6 072 070 + top + top
 Leg type B 6 072 192 + top + leg
 Leg type C - 6 LCM 6 072 206 + top + leg



Rectangular table W. 592 x D. 452 cm - 2 standard tops W. 140 cm + 8 curved tops + 4 x 90° corner units
 Leg type A 6 072 074 + top + top
 Leg type B 6 072 193 + top + leg
 Leg type C - 6 LCM 6 072 207 + top + leg

■ Seats up to 26 people



Rectangular table W. 632 x D. 452 cm - 2 standard tops W. 180 cm + 8 curved tops + 4 x 90° corner units
 Leg type A 6 072 267 + top + top
 Leg type B 6 072 268 + top + leg
 Leg type C - 6 LCM 6 072 269 + top + leg

■ Seats up to 28 people



Oval table W. 830 x D. 270 cm - 8 standard tops W. 140 cm + 4 x 90° corner tops W. 135 cm
 Leg type A 6 072 062 + top + top
 Leg type B 6 072 184 + top + leg
 Leg type C - 12 LCM 6 072 198 + top + leg



Square table W. 500 x D. 500 cm - 8 standard tops W. 180 cm + 4 x 90° corner units
 Leg type A 6 072 270 + top + top
 Leg type B 6 072 271 + top + leg
 Leg type C - 4 LCM 6 072 272 + top + leg

■ Seats up to 30 people



Rectangular table W. 630 x D. 450 cm - 6 standard tops W. 180 cm + 4 x 90° corner tops W. 135 cm
 Leg type A 6 072 273 + top + top
 Leg type B 6 072 274 + top + leg
 Leg type C - 12 LCM 6 072 275 + top + leg

Leg type A = panel leg; Leg type B = fixed metal leg without cable management; Leg type C = fixed metal leg with cable management; LCM = number of legs with cable mgt per configuration

Prestige
 2 choices of finish for wood veneer tops and panel legs (+ top)



Privilege
 3 choices of finish for melamine tops and panel legs (+ top)

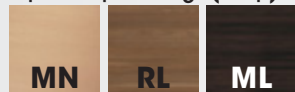

Business
 3 choices of finish for melamine tops and panel legs (+ top)

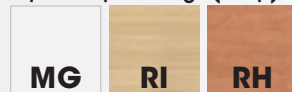

3 choices of finish for metal legs (+ leg)



Prestige

Privilege

Business

■ Seats up to 32 people



Rectangular table W. 830 x D. 410 cm - 10 standard tops W. 140 cm + 4 x 90° corner tops W. 135 cm

Leg type A 6 072 078 + top + top
 Leg type B 6 072 194 + top + leg
 Leg type C - 6 LCM 6 072 208 + top + leg



■ Seats up to 34 people



Oval table W. 990 x D. 270 cm - 8 standard tops W. 180 cm + 4 x 90° corner tops W. 135 cm

Leg type A 6 072 279 + top + top
 Leg type B 6 072 280 + top + leg
 Leg type C - 12 LCM 6 072 281 + top + leg



■ Seats up to 42 people



Rectangular table W. 990 x D. 450 cm - 10 standard tops W. 180 cm + 4 x 90° corner tops W. 135 cm

Leg type A 6 072 282 + top + top
 Leg type B 6 072 283 + top + leg
 Leg type C - 6 LCM 6 072 284 + top + leg



Leg type A = panel leg; Leg type B = fixed metal leg without cable management; Leg type C = fixed metal leg with cable management; LCM = number of legs with cable mgt per configuration

■ Optional extras

Modesty panels

Metal in a grey aluminium finish SA, graphite grey SC or SO white or Altuglas® white OA



Metal For table W. 140 cm 6 072 285 + leg
 For table W. 180 cm 6 072 287 + leg
 For 90° corner unit - D. 70 cm 6 072 289 + leg

Altuglas® For table W. 140 cm 6 072 286 + OA
 For table W. 180 cm 6 072 288 + OA
 For 90° corner unit - D. 70 cm 6 072 290 + OA



Cable trough kit and central top access cover – for elliptical tables

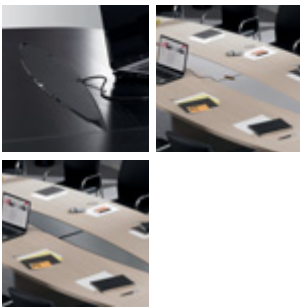

Metal For table W. 320 x D. 156 cm 6 072 225 + leg
 For table W. 460 x D. 170 cm 6 072 228 + leg
 For table W. 600 x D. 170 cm 6 072 231 + leg
 For table W. 680 x D. 170 cm 6 072 291 + leg

Altuglas® For table W. 320 x D. 156 cm 6 072 226 + OA
 For table W. 460 x D. 170 cm 6 072 229 + OA
 For table W. 600 x D. 170 cm 6 072 232 + OA
 For table W. 680 x D. 170 cm 6 072 292 + OA

Leather For table W. 320 x D. 156 cm 6 072 227 + YB
 For table W. 460 x D. 170 cm 6 072 230 + YB
 For table W. 600 x D. 170 cm 6 072 233 + YB



Concealed swivel-action power centre (European sockets only)

Please contact us for the pricing of tops with predrilled holes for power centres.



With feeder cables 6 478 022 + SA
 Without feeder cables 6 072 169 + SA



Deco cupboards matching Prestige range tables p. 242 to 255.



Cupboards and bookcases matching Privilege range tables p. 256 to 267.



Melamine storage units matching Business range tables p. 158-159.





■ PURE EVOLUTION flip-top tables

- > 25 mm thick high-density tops, covered on both sides with a decorative sheet of melamine. Edges protected by a 2 mm thick strip of ABS, which is glued to the board and rounded at the top and bottom, finish matching the tops.
- > 'I' shaped cylindrical steel legs \varnothing 70 mm attached to the extremities of the table maximising accessibility.
- > Square-section tubular steel beam (2 mm thick) 50 x 50 mm, attaches to 2 steel hinge mechanisms (5 mm thick) secured to the structure
- > Easily accessible tubular steel locking bar (35 x 20 mm and 1.5 mm thick) fitted to the underside of tops (near the front).



Aesthetically pleasing design matching our System product range. Steel legs positioned at extremities.

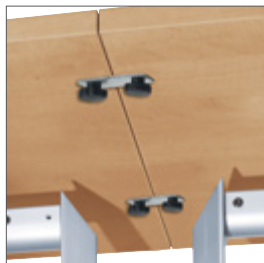

Quick & easy assembly. Connection plates allow joining of two adjacent tables. Knurled knobs provide for tool-free assembly.



Intuitive installation. Structural crossbeam secured to 2 hinges ensures the safe locking or flipping of the table top.



Safe everyday use. Manual securing /release of the locking bar. Releasing security catches enables table to be safely locked in working/storage positions.



Easy reconfiguration. A table can be installed or folded away in just 30 seconds. 4 castors \varnothing 75 mm (2 with brakes) facilitate reconfiguration of layout.



Optimised for storage. Up to 15 tables can be neatly stored in a 3 m space.



'I' shaped cylindrical steel legs (\varnothing 70 mm) with side clearance for easy access.



Rectangular tables



W. 120 x D. 80 cm
 W. 140 x D. 80 cm
 W. 160 x D. 80 cm
 W. 180 x D. 80 cm

6 430 001 + top + leg
 6 430 002 + top + leg
 6 430 003 + top + leg
 6 430 004 + top + leg

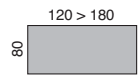

Half-moon table

W. 165 x D. 82.5 cm

6 430 005 + top + leg

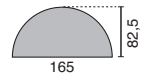

Rectangular tables with 90° curved end



W. 205 x D. 80 cm - left-hand curve 6 430 007 + top + leg
 W. 205 x D. 80 cm - right-hand curve 6 430 006 + top + leg

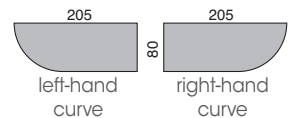

Arch-shaped (on request - allow 5 weeks for delivery)

For orders of over 5 units per model, contact us for details.

1/4 circle - D. 80 cm

W. 160 cm

6 430 008 + top + leg

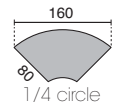

1/8 circle - D. 80 cm

W. 160 cm

6 430 009 + top + leg

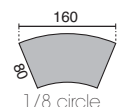

7 choices of finish for melamine tops (+ top)

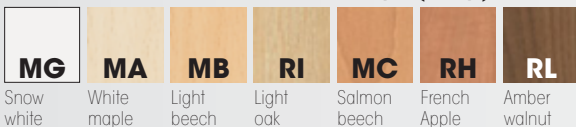

From stock

3 choices of finish for metal legs (+ leg)

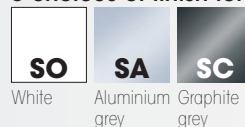

From stock





■ Folding tables

25 mm thick high-density melamine tops with a 2 mm thick strip of ABS edge banding rounded at the top and bottom, finish matching the tops.
 > Connection plates allow seamless joining of adjacent tables
 > Thumb screw fitting provide for tool-free assembly.



Rectangular tables

D. 80 cm

- W. 120 cm (on request) 6 421 053 + top + leg
- W. 140 cm 6 421 050 + top + leg
- W. 160 cm 6 421 051 + top + leg
- W. 180 cm (on request) 6 421 054 + top + leg

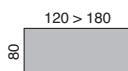

D. 68 cm (on request)

- W. 120 cm 6 421 055 + top + leg
- W. 140 cm 6 421 056 + top + leg
- W. 160 cm 6 421 057 + top + leg

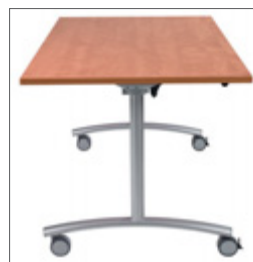

Half-moon tables

- W. 165 x D. 82.5 cm 6 421 052 + top + leg
- W. 136 x D. 78 cm (on request) 6 421 058 + top + leg

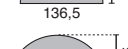
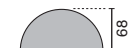

Aesthetically pleasing.
 « I » shaped legs with side clearance for easy access.

Modular and practical design.
 Easy layout reconfiguration. 4 castors (2 with brakes) ø 75 mm with 360° swivel action.

Rectangular tables with 90° curved end

- W. 205 x D. 80 cm - left-hand curve 6 421 060 + top + leg
- W. 205 x D. 80 cm - right-hand curve 6 421 059 + top + leg



Simple folding mechanism
 Square-section tubular beam 40 x 40 mm attaches to 2 steel hinge mechanisms, enabling the locking or flipping of the table.

Fast and safe handling
 Manual pressure on tubular locking bar ø 20 mm at the front of the table releases the table top for flipping. Security catches to safely lock the top in working/storage positions.

7 choices of finish for melamine tops (+ top)

MG	MA	MB	RI	MC	RH	RL
Snow white	White maple	Light beech	Light oak	Salmon beech	French Apple	Amber walnut

2 choices of finish for metal legs (+ leg)

SO	SA
White	Aluminium grey

From stock

From stock



■ Everyday folding tables

- 25 mm thick melamine high-density tops, with impact-resistant PVC edge banding.
- > Tubular legs in a chrome finish, \varnothing 30 mm.
- > Black protective end-pieces for table stacking and storage
- > juxtaposed or stacked for storage
- > Tables H. 73.5 cm



Rectangular tables

Modular

- W. 120 x D. 80 cm 6 275 032 + top + SQ
- W. 140 x D. 70 cm 6 275 033 + top + SQ
- W. 160 x D. 80 cm 6 275 036 + top + SQ

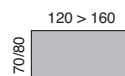

Half-moon tables

Designed as a complement to 2 rectangular tables, non-modular

- W. 140 x D. 70 cm 6 275 027 + top + SQ
- W. 160 x D. 80 cm 6 275 030 + top + SQ

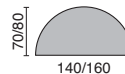

Trolley for folding tables

- > Carries up to 10 tables. Black finish.
- > Usable dimensions of the frame 160 x 70 cm
- > Tubular metal frame

Trolley 6 275 037 SG



3 choices of finish for tops from stock (+ top)

MC	RH	MF
Salmon beech	French Apple	Light grey
From stock		

1 finish for structure

SQ
Chrome
From stock

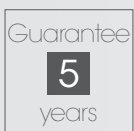



■ Modular tables

- > 25 mm thick melamine-faced high-density tops, with 2 mm thick impact-resistant ABS edge banding, finish matching the tops.
- > 3 types of leg depending on the table model: fixed or height-adjustable circular cross-section tubular legs \varnothing 60 mm, fixed square cross-section legs 60 x 60 mm or fixed central stem leg.
- > Table configurations incorporating tubular legs enable adjoining table tops to share support legs. A starter unit rests on 4 tubular legs, add-on units on 2 tubular legs.
- > Tables H. 73.5 cm

Square tables 120 x 120 cm

- On circular-section, tubular legs \varnothing 60 mm - fixed
- On circular-section, tubular legs \varnothing 60 mm - height-adjustable
- On square-section, tubular legs 60 x 60 mm - fixed
- On central stem - fixed

Starter units

- 6 238 121 + top + leg
- 6 238 061 + top + leg
- 6 238 127 + top + leg
- 6 238 130 + top + leg

Half-moon tables 120 x 120 cm

- On circular-section, tubular legs \varnothing 60 mm - fixed
- On circular-section, tubular legs \varnothing 60 mm - height-adjustable
- On square-section, tubular legs 60 x 60 mm - fixed
- On central stem - fixed

- 6 413 045 + top + leg
- 6 413 047 + top + leg
- 6 413 048 + top + leg
- 6 413 046 + top + leg

Oval conference tables

- On circular-section, tubular legs \varnothing 60 mm - fixed
- On square-section, tubular legs 60 x 60 mm - fixed

W. 240 x 120 cm

- 6 413 041 + top + leg
- 6 413 049 + top + leg

Add-on units

- 6 413 043 + top + leg
- 6 413 050 + top + leg

- 6 413 044 + top + leg
- 6 413 051 + top + leg

W. 360 x 120 cm

- 6 413 042 + top + leg
- 6 413 052 + top + leg

3 choices of finish for tops 25 mm thick (+ top)

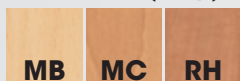

From stock

3 choices of finish for legs (+ leg)



From stock

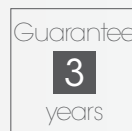
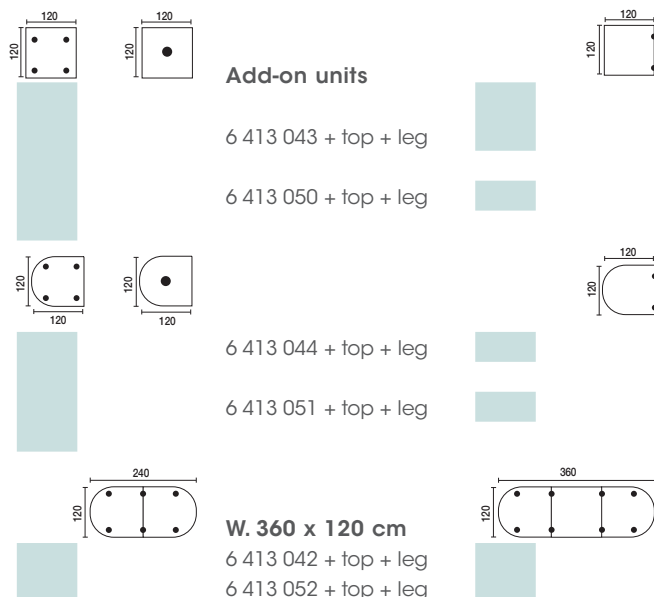

> Melamine-faced high-density tops with 8 choices of finish for 25 mm thick tops, or 3 choices of finish for 38 mm thick tops. Edges protected by a 2 mm thick strip of ABS edge banding in a matching finish.

> 8 types of leg depending on the table model:

- **5 types in SA, SC or SO finish:** circular-section tubular legs \varnothing 60 mm - fixed or height-adjustable; triangular-section tubular legs - fixed or height-adjustable; square-section legs 60 x 60 mm fixed; central stem - fixed; circular-section tubular legs \varnothing 80 mm - fixed.

- **3 types in SA or SO finish:** rounded triangular - fixed; arch-shaped 4Most rectangular - fixed; arch-shaped 4Most triangular - fixed.

> Table height (25 mm thick): H. 73.5 cm; (38 mm thick): H. 74.8 cm



■ Circular tables



Circular tables \varnothing 100 cm - 25 mm thick

On 4x circular-section, tubular legs \varnothing 60 mm - fixed	6 238 119 + top + leg
On 4x circular-section, tubular legs \varnothing 60 mm - height-adjustable	6 238 037 + top + leg
On 4x triangular-section, tubular legs - fixed	6 238 122 + top + leg
On 4x triangular-section, tubular legs - height-adjustable	6 238 046 + top + leg
On 4x square-section, tubular legs 60 x 60 mm - fixed	6 238 125 + top + leg
On central stem - fixed	6 238 128 + top + leg

Circular tables \varnothing 120 cm - 25 mm thick

On 4x circular-section, tubular legs \varnothing 60 mm - fixed	6 238 120 + top + leg
On 4x circular-section, tubular legs \varnothing 60 mm - height-adjustable	6 238 043 + top + leg
On 4x triangular-section, tubular legs - fixed	6 238 123 + top + leg
On 4x triangular-section, tubular legs - height-adjustable	6 238 047 + top + leg
On 4x square-section, tubular legs 60 x 60 mm - fixed	6 238 126 + top + leg
On central stem - fixed	6 238 129 + top + leg

Circular tables \varnothing 120 cm - 38 mm thick

On 4x rounded triangular-section legs - fixed	6 238 135 + top + SA or SO
On central stem - fixed	6 238 136 + top + SA or LW

■ Barrel tables



Barrel tables 200 x 100 cm - 25 mm thick

On 4x circular-section, tubular legs \varnothing 80 mm - fixed	6 238 131 + top + leg
On 4x square-section, tubular legs 60 x 60 mm - fixed	6 238 132 + top + leg
On 2x arch-shaped 4Most rectangular legs - fixed	6 238 133 + top + SA or SO
On 2x arch-shaped 4Most triangular legs - fixed	6 238 141 + top + SA or SO
On 2x central stems - fixed	6 238 134 + top + fin.

Barrel tables 220 x 110 cm - 38 mm thick

On 4x rounded triangular-section legs - fixed	6 238 137 + top + SA or SO
On 2x central stems - fixed	6 238 138 + top + SA or LW

■ Oval tables



Oval tables 220 x 120 cm - 38 mm thick

On 4x rounded triangular-section legs - fixed	6 238 139 + top + SA or SO
On 2x central stems - fixed	6 238 140 + top + SA or LW



Circular-section tubular legs \varnothing 60 mm



Square-section legs 60 x 60 mm



Triangular-section tubular legs



Rounded triangular-section tubular legs



Central stem



8 choices of finish for 25 mm thick tops (+ top)

MG	MA	MB	RI	MC	RH	RL	MJ
Snow white	White maple	Light beech	Light oak	Salmon beech	French Apple	Amber walnut	Chocolate wenge

From stock

3 choices of finish for 38 mm thick tops (+ top)

MN	RL	ML
White oak	Amber walnut	Brown oak

From stock

4 choices of finish for legs (+ leg)

SO	SA	SC	LW
White	Aluminium grey	Graphite grey	Black gloss*

From stock

* Only for 38 mm thick models with central stem

Multi-purpose modular tables

- > Melamine 19 mm thick tops, edge protected by 2 mm thick strip of ABS.
- > Graphite grey finish structural frame.
- > Square-section tubular legs 30 x 30 mm or circular-section legs \varnothing 32 mm
- > Adjustable stabilizer feet
- > Tables H. 73.5 cm

Rectangular tables

- W. 120 x D. 60 cm
- W. 140 x D. 70 cm
- W. 160 x D. 80 cm
- W. 180 x D. 80 cm

Half-moon tables

- W. 120 x D. 60 cm
- W. 140 x D. 70 cm
- W. 160 x D. 80 cm

Trapeziform tables

- W. 120 x D. 60 cm
- W. 140 x D. 70 cm

Square legs

- 6 298 013 + top + leg
- 6 298 017 + top + leg
- 6 298 021 + top + leg
- 6 298 024 + top + leg

Circular legs

- 6 298 201 + top + leg
- 6 298 202 + top + leg
- 6 298 203 + top + leg
- 6 298 204 + top + leg

- 6 298 001 + top + leg
- 6 298 005 + top + leg
- 6 298 009 + top + leg

- 6 298 025 + top + leg
- 6 298 029 + top + leg

5 choices of finish for tops (+ top)



4 choices of finish for legs (+leg)

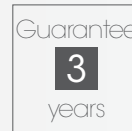
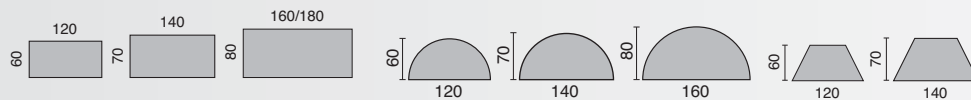

Easy access tables

- > 25 mm thick melamine tops with straight edges protected by 2 mm thick ABS edge banding.
- > Fixed tubular steel structural crossbeam.
- > Tubular legs \varnothing 30 mm with side clearance for easy access
- > Circular-section tubular central stem legs \varnothing 80 mm, and branch-shaped base composed of 4 cylindrical tubular feet \varnothing 35 mm, for circular tables.
- > Adjustable stabilizer feet
- > Tables H. 73.5 cm

Rectangular tables

- W. 80 x D. 80 cm
- W. 120 x D. 80 cm
- W. 140 x D. 80 cm
- W. 160 x D. 80 cm
- W. 180 x D. 80 cm

- 6 606 001 + top + SA
- 6 606 002 + top + SA
- 6 606 003 + top + SA
- 6 606 004 + top + SA
- 6 606 005 + top + SA

90° link unit (non-modular)

- W. 80 x D. 80 cm

- 6 606 019 + top

Half-moon table (non-modular)

- W. 165 x D. 60 cm

- 6 606 009 + top + SA

Stand-up meeting table

- W. 120 x H. 110 x D. 60 cm

- 6 606 010 + top + SA

Circular tables

- \varnothing 100 cm
- \varnothing 120 cm

- 6 606 006 + top + SA
- 6 606 007 + top + SA

7 choices of finish for tops (+ top)



1 finish for legs (+ leg)

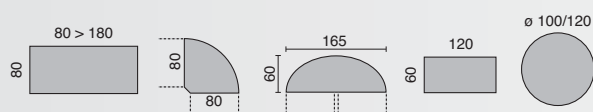



■ Lacquered whiteboards



- > White lacquered steel board
- > Anodised aluminium frame
- > Magnetic dry wipe panel for use with marker pens
- > Supplied with a pen tray
- > Can be mounted on wall horizontally or vertically (includes assembly kit)

60 x 90 cm	6 386 110
90 x 120 cm	6 386 111
90 x 180 cm	6 386 112



■ Enamelled whiteboards



- > White enamelled steel board
- > Anodised aluminium frame
- > Magnetic dry wipe panel for use with marker pens
- > Supplied with a pen tray
- > Can be mounted on wall horizontally or vertically (includes assembly kit)

60 x 90 cm	6 386 096
90 x 120 cm	6 386 093
90 x 180 cm	6 386 094
120 x 180 cm	6 386 095



■ Frameless lacquered whiteboard



Magnetic wall-mounts

- > White lacquered steel boards
- > Magnetic dry wipe panels for use with marker pens
- > 'Frameless' panels allow multiple panels to be joined seamlessly together. This concept allows the creation of a large usable surface area or can facilitate the creative process.
- > Attaches to walls by means of 4 magnetic wall-mounts (includes assembly kit)
- > Can be mounted on wall horizontally or vertically
- > Supplied with a pen tray

75 x 115 cm	6 386 109
-------------	-----------



■ Multi-panel whiteboard



- > White enamelled steel board
- > Anodised aluminium frame
- > 5 magnetic dry wipe surfaces for use with marker pens
- > Supplied with a pen tray
- > Can be mounted on wall horizontally (includes assembly kit)
- > Whiteboard dimensions when open: 90 x 240 cm

90 x 120 cm	6 386 113
-------------	-----------



■ Accessories



Accessory kit for whiteboards and coloured glass boards

- > 4 marker pens (black, blue, green and red)+ 6 magnets
- + 1 magnetic eraser + 125 ml of cleaning product

6 386 116



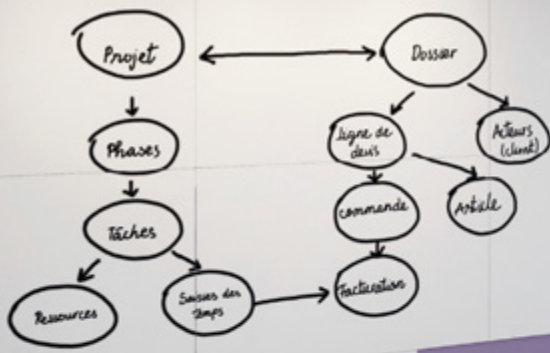

■ Cork noticeboards



- > Natural corkboard surface, 12 mm thick (overall).
- > Anodised aluminium frame
- > Can be mounted on wall horizontally or vertically (includes assembly kit)

60 x 90 cm	6 386 082
90 x 120 cm	6 386 083
90 x 180 cm	6 386 084



■ Coloured glass board



- > Toughened glass 4 mm thick
- > Magnetic dry wipe surfaces for use with marker pens
- > Assembly kit and screws supplied with the board
- > Supplied with 2 magnets
- > Additional accessory kit available p. 202

48 x 48 cm	6 386 008 + fin.
------------	------------------

3 choices of finish from stock (+ fin.)

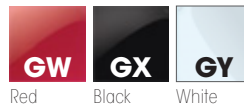

Red Black White



Optional extra

White marker pen
For coloured glass boards



6 386 115



■ Identification plates



> Anodised aluminium structure with non-reflective transparent acrylic front panel
 > Frame can be personalised by slotting in trim bands that come in 6 different colours (dark wood, light wood, black, grey, orange and blue for wall-mounted plates/ grey, black, prune and aniseed green for the free-standing plates).
 > Attach by means of adhesive or screws for models 1 2 3 4

1 Door plates - sold in sets of 5

H. 5.5 x W. 8.5 cm 6 544 006

2 A5 plate

H. 14.8 x W. 21 cm 6 544 007

3 A4 plate

H. 29.7 x W. 21 cm 6 544 008

4 A3 plate (on request)

H. 42 x W. 29.7 cm 6 544 005

5 A4 document display stand - freestanding on post

(rotates into landscape or portrait orientation)

H. 120 x W. 26.9 x D. 27 cm 6 541 017 ZA



■ Literature stands



> Metal stands in an aluminium grey and shelves in ABS

6 Fixed narrow (6 compartments)

H. 93 x W. 34 x D. 50 cm 7 543 001 ZA

7 Fixed wide (8 compartments)

H. 93 x W. 58 x D. 50 cm 7 543 002 ZA

8 Mobile narrow (5 compartments, 4 lockable castors)

H. 165 x W. 39 x D. 58 cm 7 543 003 ZA



■ Flipchart easel



> Magnetic lacquered back panel
 > Dry wipe panel for use with marker pens and paper flipchart
 > Height-adjustable (max height: 195 cm / min height: 110 cm)
 > Integrated pen tray
 > Black plastic frame

Panel dimensions :

H. 104 x W. 68 cm 6 386 117



■ Mobile flipchart easel



- > Magnetic lacquered back panel
- > Dry wipe panel for use with marker pens and paper flipchart
- > Height not adjustable. Overall height = 186 cm
- > Black metal pen tray
- > Fitted with 5 lockable castors

Panel dimensions:
H. 104 x W. 68 cm 6 386 118



■ 'Vary' flipchart easel



- > Versatile easel that can be re-configured into a table
- > Magnetic lacquered back panel
- > Dry wipe panel for use with marker pens and paper flipchart
- > Height-adjustable (max height: 190 cm / min height: 150 cm)
- > Extending arms either side maximizes presentation possibilities
- > Adjustable pen tray
- > Fitted with 5 lockable castors

Panel dimensions:
H. 104 x W. 68 cm 6 386 119



■ Mobile whiteboard



- > Dual-sided mobile board mounted on horizontal pivot, with white lacquered panel and steel frame
- > Dry wipe panel for use with marker pens
- > Overall dimensions: H. 180 x W. 126.5 x D. 55 cm
- > Metal pen tray supplied
- > Fitted with 4 lockable castors

Panel dimensions:
H. 90 x W. 120 cm 6 386 108



■ Accessories



Accessory kit
> 4 marker pens (black, blue, green and red) + 6 magnets + 1 magnetic eraser + 125 ml of cleaning product

6 386 116



Refill pads
> Pack of 5 refill pads containing 50 sheets of white paper
> Format 100 x 65 cm

6 386 114



■ 9A4 lockable indoor window board

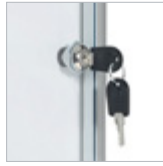

- > Magnetic lacquered back panel
- > Swing door
- > 4 mm thick acrylic door
- > Anodized aluminium frame
- > Ideal for mounting on walls (screws included)
- > Lockable, 2 keys supplied

H. 98 x D. 72 x Thickness 3.5 cm 6 542 010



■ 12A4 lockable indoor window board

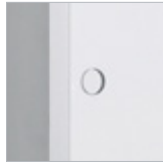

- > Magnetic lacquered back panel
- > Sliding doors opening
- > 5 mm thick toughened glass sliding doors
- > Anodized aluminium frame
- > Ideal for mounting on walls (screws included)
- > Lockable, 2 keys supplied

H. 92 x D. 97 x Thickness 7.5 cm 6 542 011



■ 9A4 lockable outdoor window board

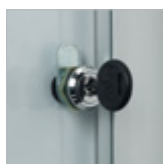

- > Magnetic lacquered back panel
- > Swing door
- > 4 mm thick toughened glass swing door
- > Silicone gasket around the perimeter of the casing and steel back panel to prevent penetration of dust and humidity
- > Ideal for mounting on walls (screws included)
- > Special wall-mounting application to avoid direct contact with the wall
- > Lockable, 2 keys supplied

H. 99 x D. 82 x Thickness 5.7 cm 6 542 009





■ 9A4 lockable indoor window board



- > Cork back panel
- > Swing door
- > 4 mm thick acrylic front panel
- > Anodized aluminium frame
- > Ideal for mounting on walls (screws included)
- > Lockable, 2 keys supplied

H. 98 x D. 72 x Thickness 3.5 cm 6 542 012



■ 12A4 lockable indoor window board



- > Cork back panel
- > Sliding doors
- > 5 mm thick toughened glass sliding doors
- > Anodized aluminium frame
- > Ideal for mounting on walls (screws included)
- > Lockable, 2 keys supplied

H. 92 x D. 97 x Thickness 7.5 cm 6 542 013



- > Melamine 25 mm thick tops
- > Rectangular table tops are supported by a fixed tubular steel structural crossbeam and legs in an aluminium grey finish
- > Circular tables with central stem in an aluminium grey finish

- > Tables H. 73.5 cm and 110 cm (snack)
- > Beech plywood seat with natural wood varnish, structure in an aluminium grey finish

■ Tic canteen tables



> Height 73.5 cm

Square table		
W. 80 x D. 80 cm	6 503 001 + top + SA	
Rectangular tables		
W. 120 x D. 80 cm	6 503 002 + top + SA	
W. 140 x D. 80 cm	6 503 003 + top + SA	
W. 160 x D. 80 cm	6 503 004 + top + SA	
Circular tables		
ø 100 cm	6 503 011 + top + SA	
ø 120 cm	6 503 012 + top + SA	

■ Tic snack tables







> Height 110 cm

Square table*		
W. 60 x D. 60 cm	6 503 006 + top + SA	
Rectangular table*		
W. 120 x D. 60 cm	6 503 009 + top + SA	
Circular table*		
ø 60 cm	6 503 010 + top + SA	
Wall-mounted shelf		
W. 120 x D. 43 cm	6 503 079 + top + SA	

***Only available in MB, MC and MG**

■ Tic chairs



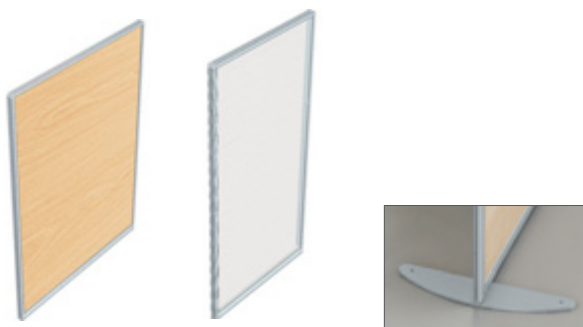

4 leg chair		
Sold exclusively in pairs		
> Seat height: 47 cm		
Set of 2 chairs	6 503 016 WP	Unit price 
Reverse cantilever chair		
Sold exclusively in pairs		
> Seat height: 47 cm		
Set of 2 chairs	6 503 017 WP	Unit price 
Wooden high chair		
> Seat height: 77 cm		
	6 503 018 WP	
Kantine chairs		
Sold exclusively in pairs		
> Seat height: 45 cm		
Set of 2 chairs	6 510 014 WP SB	Unit price 

■ Partition screens



> Profiled aluminium frame 22 mm thick > 4 choices of melamine finish (snow white MG, white maple MA, light oak RI, French apple RH) and polycarbonate panels with honeycomb pattern PV > Connector kit (included) allows positioning of screens in line end-to-end or in a variety of directions. **Allow for 1 stabilizer foot at each extremity and 1 shared between every 2 panels positioned in line > H. 160 cm**

Melamine screen		
W. 80 cm	6 503 074 + top + SA	
W. 120 cm	6 503 075 + top + SA	
Polycarbonate screen		
W. 80 cm	6 503 076 PV SA	
W. 120 cm	6 503 077 PV SA	
Stabilizer foot		
Unit price	6 503 078 SA	

Optional castors available p. 137.



■ Trolley



> Melamine panels in a salmon beech finish, 19 mm thick > Tubular structure ø 40 mm in an aluminium grey finish > Grip handle > Maximum load 80 kg

W. 60 x D. 48 x H. 79 cm

6 503 019 MX SB



■ Storage units



> Cupboard shells and shelves in 19 mm thick melamine with in an aluminium grey finish > Doors and optional melamine tops, matching the 7 choices of table top finishes available > Metal handles in an aluminium grey finish > 3 point lock for high cupboards and single point lock for medium and low cupboards > W. 80 x D. 42.6 cm

Low cupboards H. 69.3 cm

2 plain doors 6 503 020 + top + MH
With refrigerator* 6 503 027 + top + MH



Medium cupboard H. 133.3 cm

2 plain doors + 2 shelves 6 503 024 + top + MH



High cupboard H. 197.3 cm

5 shelves 6 503 025 MH



Melamine top and shelf

25 mm thick
W. 80 x D. 43.2 cm 6 503 029 + top



* On request

7 choices of finish depending on model (+ top)



MG	MA	MB	RI	MC	RH	RL
Snow white	White maple	Light beech	Light oak	Salmon beech	French Apple	Amber walnut

From stock

Screens p. 136.



Storage units p. 158.



■ Canteen tables



Rectangular tables

- > Melamine 25 mm thick tops, height 73.5 cm
- > Rectangular table tops D. 80 cm
- > Rectangular legs in an aluminium grey finish

W. 120 cm	6 444 017 + top + SA
W. 140 cm	6 444 002 + top + SA
W. 160 cm	6 444 018 + top + SA



Square snack tables

- > Melamine 25 mm thick tops.
- > Square table tops dimensions 80 x 80 cm
- > Square leg and base plate in an aluminium grey finish

H. 73.5 cm	6 444 003 + top + SA
H. 105 cm	6 444 004 + top + SA



Circular tables

- > Melamine 25 mm thick tops, height 73.5 cm
- > Central stem on circular base plate in an aluminium grey finish

ø 100 cm	6 488 035 + top + SA
ø 120 cm	6 488 036 + top + SA



Circular snack tables

- > Melamine 25 mm thick tops, ø 60 cm
- > Central stem on circular base plate in an aluminium grey finish

H. 72 cm	6 488 005 + top + SB
H. 106 cm	6 488 003 + top + SB



- > Glass table top 10 mm thick in a white finish, ø 60 cm
- > Central stem on circular base plate in an aluminium grey finish

H. 72 cm	6 488 006 GG SB
H. 106 cm	6 488 003 GG SB



3 choices of finish for tops (+ top)



MG	MB	MC
Snow white	Light beech	Salmon beech

From stock

1 finish for glass tops

GG
White

From stock









■ Spoon chairs and stools

- > Structure in a chrome finish.
- > Seat shell/backrest in beech plywood coated with natural wood varnish, white lacquer finish or red/white lacquer finish.
- > Seat height: regular chair: 47 cm; 4 leg stool: 74 cm; gas lift stool: 53 to 79 cm (adjusts through 26 cm)



Sold exclusively in pairs of the same colour.

	Light beech	Lacquered
Regular chairs		
Set of 2 chairs 6 451 001 + col. + SQ		
Unit price		
4 leg stools		
Set of 2 stools 6 451 002 + col. + SQ		
Unit price		
Gas lift stool		
Set of 2 stools 6 451 003 + col. + SQ		
Unit price		

3 choices of colour (+ col.)



Light beech White/Red White

From stock



■ Bali restaurant furniture

> Acrylic seat shell in transparent or opaque aspect > Metal frame in an aluminium grey finish

Sold exclusively in pairs of the same colour.

4 leg chair

> Seat height: 46 cm

Set of 2 chairs

6 444 005 + col. + SB

Unit price



4 leg high chairs

> Seat height: 75 cm

Set of 2 chairs

6 444 006 + col. + SB

Unit price



Gas lift stools

> Gas lift stem 56 to 82 cm (adjustable through 26 cm)

Set of 2 stools

6 488 018 + col. + SB

Unit price



7 choices of colour for transparent acrylic seats (+ col.)

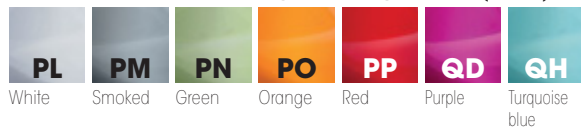

From stock

2 choices of colour for opaque acrylic seats (+ col.)



From stock

■ Pim's canteen furniture

Indoor/outdoor chairs

> Tubular anodised aluminium frame > Polypropylene seat/backrest shell, treated for protection against UVs > Seat height: 45 cm

Sold exclusively in pairs of the same colour.

Set of 2 chairs

6 449 004 + col. + SB

Unit price



Indoor/outdoor table

> Structure in an aluminium grey finish, treated for protection against corrosion > Table tops in Topalit 18 mm thick, ø 60 cm. Graphite grey finish

H. 73.5 cm

6 449 003 PY SB



5 choices of colour for polypro seats (+ col.)

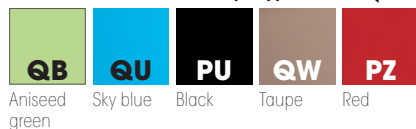

From stock

■ Zouc stools

213

> Polypropylene seats in a white or black finish > Frame in an aluminium grey finish > 2 types of legs: 4 leg stool 76 cm or gas lift stem 56 to 82 cm (adjusts through 26 cm)

Sold exclusively in pairs of the same colour.



4 leg stool

Set of 2 stools

6 390 001 + col. + SB

Unit price



Gas lift stools

Set of 2 stools

6 390 002 + col. + SB

Unit price



2 choices of colour for polypro seats (+ col.)

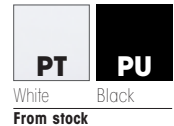

From stock

■ Joker stools

> Simulated leather covering > Foam seat ø 36 cm > Tubular frame structure in a chrome finish > Seat height 83 cm

Sold exclusively in pairs.



Stools

Set of 2 stools

5 533 004 YA SQ

Unit price



■ Lilly chairs

> Structure in a chrome finish > Polypropylene seat and backrest > Seat height: 46 cm – seat width: 49 cm

Sold exclusively in pairs of the same colour.



4 leg frame

Set of 2 chairs

6 448 001 + col. + SQ

Unit price



3 choices of colour for polypro seats (+ col.)



From stock