

# WORKSPACE



## A DESK REFLECTING YOUR IMAGE

It is certainly the most personal of spaces within the company, since it reflects the personality and management style of its leader.

At times a place for face-to-face exchanges, for meetings and concentration, this authoritative space embraces ergonomics and a considered visual aesthetic.

Characterised by clean and elegant lines, our executive desks are the perfect solution with which to furnish these environments.

For a more contemporary style, lean towards the timeless designs of the MOKA and KARA ranges.

If it is a more traditional style you are after, RIO is ideal as it provides a respectable desking solution for open-spaces as much as private offices.

## Executive desks

KARA .....	40
RIO .....	48
MOKA .....	52

# KARA

KARA instantly stands out by the generous thickness of its worktops and its timeless design style. Its worktops and storage units adapt to a users' every need, allowing numerous layout configurations, offering an extensive work surface and making it the perfect desking solution for managerial or executive spaces.



Rectangular desk W. 170 cm, square section melamine legs with melamine cladding. Royal brown oak finish, matching modesty panel.



• Executive chairs, page 195

Rectangular desk W. 200 cm including a structural pedestal with 3 drawers and an offset return with melamine top. Amber walnut decorative finish.



- Executive chairs, page 195
- Cable and Power management, page 273



## Classic & refined

Melamine worktop  
38 mm thick,  
3 choices of finish

Desk return  
fitted with  
2 cable ports

Optional enamelled  
toughened glass top  
6 mm thick



Legs mounted on metal  
plates with adjustable  
stabilizer feet

Melamine  
modesty panel

Desk return  
with 2 strips of  
aluminium trim

Struts

### 2 TYPES OF LEG DESIGN



Melamine  
panel leg



Square section metal  
legs 60 x 60, melamine  
cladding in a matching  
finish to worktop

# FINISHES & PRODUCT OVERVIEW

**3** choices of finish for melamine worktops with panel legs, structural pedestals or closed panel returns in a matching finish (+ top)

**2** choices of metal finish for legs with melamine cladding matching the worktop (+ fin.)

**1** choice of glass top finish



**RI**  
Light oak



**RL**  
Amber walnut



**MT**  
Royal brown oak

FROM STOCK

---

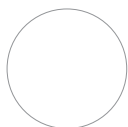

**SO**  
White



**SA**  
Aluminium grey

FROM STOCK

---



**GS**  
Glossy enamelled white

FROM STOCK

Individual desks

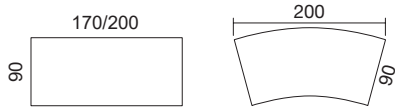

Desks with closed panel return

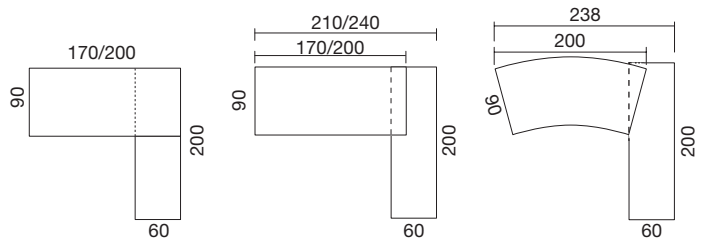

Desks with structural pedestal

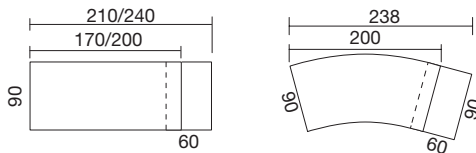

Desks with structural pedestal and closed panel return

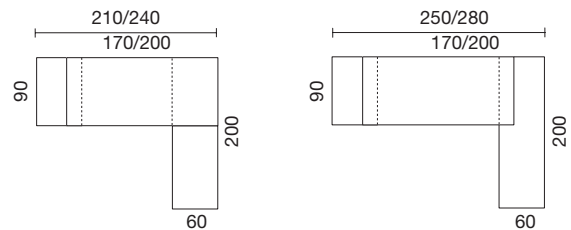

Meeting tables

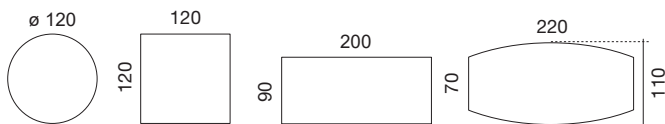

Storage units

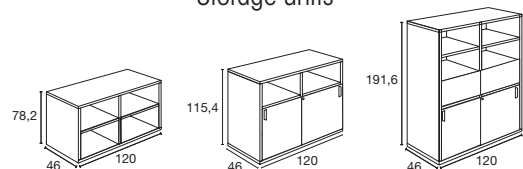

# PRICES

Price excl. taxes :

**From stock**

On request

Melamine panel legs  
with modesty panel

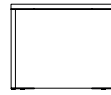

Square section metal legs  
Melamine cladding to both external facades

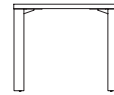

(Melamine leg in matching finish to worktop)

## WORKSPACE

### D. 90 cm

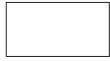

#### Rectangular worktops

W.170 cm

3 636 113

3 636 190

W. 200 cm

3 636 115

3 636 191



#### Curved worktops

W. 200 cm

3 636 320

3 636 561

Desks with 3 drawer structural pedestal. Structural pedestal can be placed on left or right-hand side.

#### Rectangular with structural pedestal - melamine top

W. 210 cm

3 636 114

3 636 562

W. 240 cm

3 636 116

3 636 563



#### Rectangular with structural pedestal - glass top\*

W. 210 cm

3 636 321

3 636 662

W. 240 cm

3 636 322

3 636 663



#### Curved with structural pedestal - melamine top

W. 238 cm

3 636 323

3 636 564

#### Curved with structural pedestal - glass top\*

W. 238 cm

3 636 324

3 636 664

### D. 200 cm

Desks with closed panel return. Return can be placed on either the left or right-hand side.

#### Rectangular with aligned return - melamine top

W.170 cm

3 636 301

3 636 568

W. 200 cm

3 636 308

3 636 569

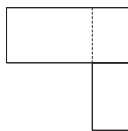

#### Rectangular with ALIGNED return - glass top\*

W.170 cm

3 636 302

3 636 668

W. 200 cm

3 636 309

3 636 669

#### Rectangular with offset return - melamine top

W. 210 cm

3 636 396

3 636 565

W. 240 cm

3 636 399

3 636 566

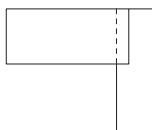

#### Rectangular with OFFSET return - glass top\*

W. 210 cm

3 636 304

3 636 665

W. 240 cm

3 636 306

3 636 666

#### Curved with offset return - melamine top

W. 238 cm

3 636 307

3 636 567

#### Curved with OFFSET return - glass top\*

W. 238 cm

3 636 310

3 636 667

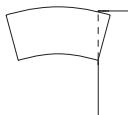

\* For the glass top version: Ref. + top + top + GS for panel leg version or Ref. + top + fin + GS for metal leg version.

# PRICES

Price excl. taxes : **From stock** **On request**

## WORKSPACE (Continued)

Ref. + top + top\*

### D. 200 cm

Desks with closed panel return and structural pedestal. Structural pedestal and return can be placed on either the left or right-hand side.

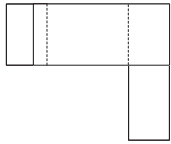

#### With 3 drawer structural pedestal and aligned return - 2 melamine tops

W. 210 cm	3 636 394	
W. 240 cm	3 636 398	

#### With 3 drawer structural pedestal and aligned return - 1 glass top\*

W. 210 cm	3 636 313	
W. 240 cm	3 636 314	

#### With 3 drawer structural pedestal and aligned return - 2 glass tops\*

W. 210 cm	3 636 311	
W. 240 cm	3 636 312	

#### With 3 drawer structural pedestal and offset return - 2 melamine tops

W. 250 cm	3 636 397	
W. 280 cm	3 636 300	

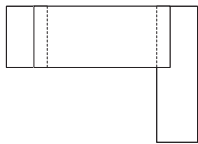

#### With 3 drawer structural pedestal and offset return - 1 glass top\*

W. 250 cm	3 636 315	
W. 280 cm	3 636 316	

#### With 3 drawer structural pedestal and offset return - 2 glass tops\*

W. 250 cm	3 636 303	
W. 280 cm	3 636 305	

Standard worktops

Worktops with pre-cut openings  
(cable trough included)



## MEETING SPACES

Ref. + top + fin.

Ref. + top + fin.



#### Circular table. 4 square section metal legs - melamine cladding.

Ø 120	3 636 203	
-------	-----------	--

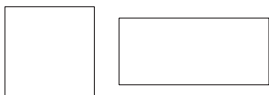

#### Square and rectangular tables. 4 square section metal legs - melamine cladding.

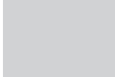
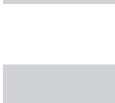
W. 120 x D. 120 cm	3 636 165		3 636 581
W. 200 x D. 90 cm	3 636 166		3 636 582

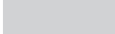

#### Barrel shaped table. 4 square section metal legs - melamine cladding.

W. 200 x D. 90 cm	3 636 202		3 636 583
-------------------	-----------	--	-----------

\* For the glass top version: Ref. + top + top + GS.

## STORAGE UNITS

Ref. + top + SA

### Melamine mobile pedestals. W. 40 x D. 60 x H. 55.40 cm

Integrated pen tray. Selective drawer opening system, full depth extraction. Central locking. Metal handles in an Aluminium grey finish.

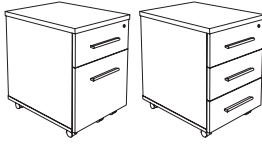

1 box drawer + 1 SF	3 636 584
3 drawers	3 636 585

### Cupboards

Ref. + top + MG

Ref. + top + MG + GS

Melamine cupboard shell 38 mm thick in wood decorative finish, back and front panels 19 mm thick in a Snow white MG finish. Swing doors and drawers: opening by push-release system. Sliding doors in a Snow white MG finish or toughened safety glass GS, with lock. Select cupboard models can be fitted with swing doors and drawers, but they do not include rails to allow fitting of sliding doors. Cupboards with sliding doors feature guide rails fitted to the top and base of the units. High cupboards are formed by the combination of a medium and a low cupboard. W. 120 x D. 46 cm.

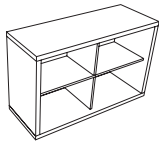

#### Low cupboards H. 78.2 cm - 1 shelf

	Melamine sliding doors	Glass sliding doors
Without doors	3 636 204	
2 swing doors	3 636 206	
4 swing doors	3 636 207	
2 sliding doors	3 636 205	3 636 220



#### Medium cupboards H. 115.4 cm - 2 shelves

Without doors	3 636 208	
3 swing doors	3 636 212	
2 swing doors + 1 drawer unit	3 636 211	
2 sliding doors	3 636 209	3 636 221
2 sliding doors + 1 drawer unit	3 636 210	3 636 222

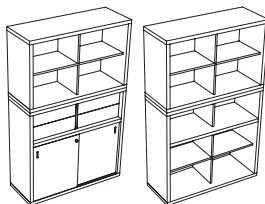

#### High cupboards H. 193.6 cm - 4 shelves

Without doors	3 636 213	
6 swing doors	3 636 216	
2 sliding doors + 2 swing doors	3 636 214	3 636 223
2 sliding doors + 2 drawer units	3 636 215	3 636 224

## OPTIONS

Ref.

Modesty panels for metal legs. Not compatible with desks incorporating an aligned return.

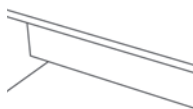

#### Metal

Rectangular worktop W. 170 cm	3 636 200 + fin.
Rectangular worktop W. 200 cm	3 636 201 + fin.
Rectangular worktop W. 200 cm	3 636 586 + fin.

#### Melamine

Rectangular worktop W. 170 cm	3 500 518 + top
Rectangular worktop W. 200 cm	3 500 519 + top
Curved worktop W. 170 cm	3 500 519 + top



**Power and cable management**  
Optional - see page 273



**Top access housing**  
Module to be ordered separately

## FINISHES

Choice of finish for melamine worktops, panel legs, structural pedestals or closed panel returns in matching finish (+ top)



RI



RL



MT

Choice of metal finish for legs (+ fin.)



SO



SA

Choice of glass top colour finish



GS

FROM STOCK

# RIO

RIO is presented in a choice of either melamine or glass enamelled worktops mounted on a metal frame. Its sober and decidedly contemporary aesthetic make this desk the ideal solution for the fitting out of managerial spaces, whether in an open-space floorplan or in private offices.



- Cupboards, page 121
- Ergonomic chairs, page 195
- Decorative lamps, page 253



## Modern & sober

### Melamine worktop

25 mm thick, 4 choices of finish

### Glass worktop

8 mm thick, 2 choices of colour

### Melamine worktops **new**

with drilled out openings for cable ports  
or pre-cut for top access housings



**Metal bridge design legs**  
on adjustable stabilizer feet  
2 choices of finish

### 3 RETURN DESIGNS



**Structural return**  
with Altuglas® sliding doors  
on matching metal legs



**Fixed return**  
1 bridge shaped leg  
to create a lighter structure



**Free-standing return**  
2 bridge  
design metal legs

# FINISHES & PRODUCT OVERVIEW

4 choices of melamine worktop (+ top 1)



2 choices of metal finish for legs (+ fin.)

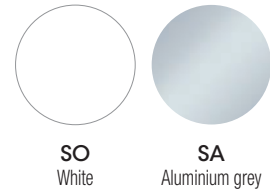

FROM STOCK

2 choices of glass colour finish for worktops (+ top 2)



2 choices of Altuglas® sliding door colour (+ col.)



FROM STOCK

## Individual desks

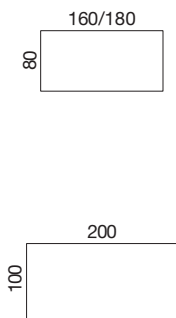

## Desks with structural returns

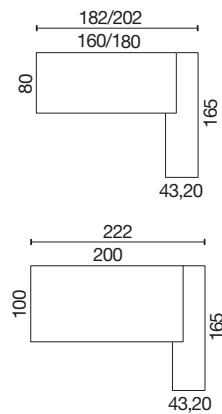

## Desks with fixed returns

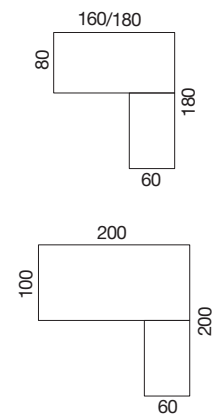

## Extension units

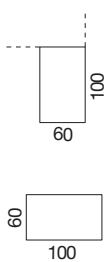

## Meeting tables

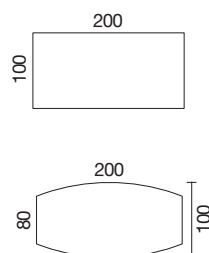

## Power and cable management (for melamine worktops)

### Desks

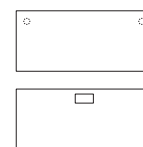

### Meeting tables



# PRICES

Price excl. taxes : From stock On request

WORKSPACE	Melamine worktops with drilled out openings for cable ports		Pre-cut melamine worktops with openings for top access housings (cable trough included) 		Glass top	
	Ref. + top 1 + fin.		Ref. + top 1 + fin.		Ref. + top 2 + fin.	
<b>Rectangular desks</b>						
W. 160 x D. 80 cm	3 665 315		3 665 600		3 665 318	
W. 180 x D. 80 cm	3 665 316		3 665 601		3 665 319	
W. 200 x D. 100 cm	3 665 317		3 665 602		3 665 320	
	Réf. + décor 1 + fin. + col.		Réf. + décor 1 + fin. + col.		Réf. + décor 2 + fin. + col.	

**Rectangular desks with structural returns** - Melamine return in MG (White) or MU (Aluminium grey) finish, matching the legs - Altuglas doors OA/OB (+ col.)

> **Structural return with user side access**

W. 182 x D. 165 cm	3 665 603		3 665 606		3 665 609	
W. 202 x D. 165 cm	3 665 604		3 665 607		3 665 610	
W. 222 x D. 165 cm	3 665 605		3 665 608		3 665 611	

> **Structural return with double sided access**

W. 182 x D. 165 cm	3 665 321		3 665 612		3 665 324	
W. 202 x D. 165 cm	3 665 322		3 665 613		3 665 325	
W. 222 x D. 165 cm	3 665 323		3 665 614		3 665 326	

	Ref. + top 1 + fin.		Ref. + top 1 + fin.		Ref. + top 2 + fin.	
--	---------------------	--	---------------------	--	---------------------	--

**Rectangular desks with fixed returns**

W. 160 x D. 180 cm	3 665 327		3 665 615		3 665 330	
W. 180 x D. 180 cm	3 665 328		3 665 616		3 665 331	
W. 200 x D. 200 cm	3 665 329		3 665 617		3 665 332	

**Fixed returns** - Positioned to the left or right-hand side of rectangular desks.

W. 100 x D. 60 cm	3 665 333				3 665 334	
-------------------	-----------	--	--	--	-----------	--

**Free-standing return**

W. 100 x D. 60 cm	3 665 335				3 665 336	
-------------------	-----------	--	--	--	-----------	--

	Ref. + fin.		Ref. + fin.		Ref. + fin.	
--	-------------	--	-------------	--	-------------	--

**Metal modesty panels** - Modesty panel attaches to the underside of melamine worktops or secures to a crossbeam spanning the legs of glass top desks.

	For free-standing desks or desks with fixed returns		For desks with structural returns	
W. 160 cm	3 665 103		3 665 337	
W. 180 cm	3 665 104		3 665 103	
W. 200 cm	3 665 105		3 665 104	

MEETING SPACE	Melamine worktop		Pre-cut melamine worktops with openings for top access housings (cable trough included)		Glass top	
	Ref. + top 1 + fin.		Ref. + top 1 + fin.		Ref. + top 2 + fin.	
<b>Rectangular table</b>						
W. 200 x D. 100 cm	3 665 317		3 665 618		3 665 320	
<b>Barrel shaped table</b>						
W. 200 x D. 100 cm	3 665 619		3 665 620			

 **Top access housing**  
Module to be ordered separately

\* From stock worktop availability in RI finish only.

# MOKA

MOKA is a favourite in the furnishing of executive office spaces. With its characteristic panel legs, it projects allure and poise throughout your work space. Combined with its matching range of easy reach storage solutions, this is the ideal desk for managers seeking tradition and practicality.



- Executive chairs, page 195
- Cupboards, page 121
- Cable and Power management, page 273



## Timeless & functional

### Melamine worktop

25 mm thick, 3 choices of finish  
Pre-drilled worktops with openings  
to receive optional cable ports\*

### Structural modesty panel

with openings foreseen in  
the upper section to facilitate  
cable routing



Aluminium grey  
struts

Legs with  
height-adjustable  
feet

### 3 STORAGE UNIT DESIGNS



Structural return  
with user side access



Structural return  
with visitor side access



Mobile  
pedestal

\* Cannot be located on the extremity supported by a structural return.

# FINISHES & PRODUCT OVERVIEW

3

choices of finish for melamine worktops, panel legs, structural pedestals or closed panel returns in matching finish (+ top)



**RI**  
Light oak



**RL**  
Amber walnut

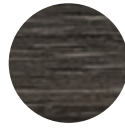

**MT**  
Royal brown oak

FROM STOCK

1

choice of sliding door melamine finish on structural return



**MU**  
Aluminium grey

FROM STOCK

## Individual desks

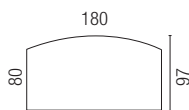
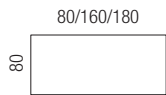

## Desks with structural return unit

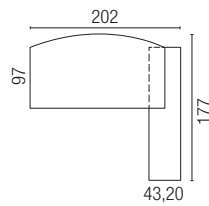
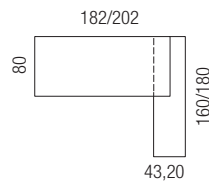

## Panoramic desks

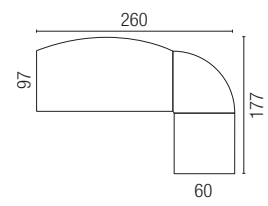
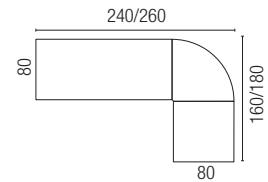

## Corner angle unit



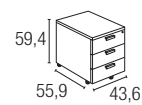
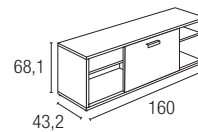

## Easy-reach storage units



# PRICES

Price excl. taxes : **From stock** **On request**

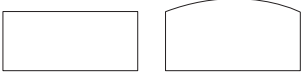
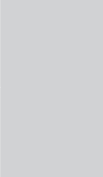
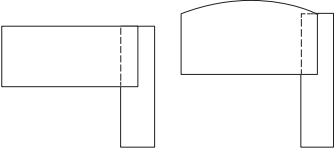
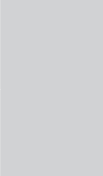
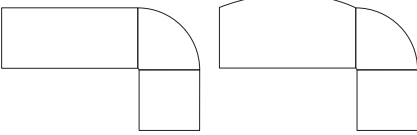
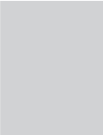
## WORKSPACE

		Ref. + top	
<b>Individual desks</b>			
	Rectangular desk W. 80 x D. 80 cm	3 442 500	
	Rectangular desk W. 160 x D. 80 cm	3 442 501	
	Rectangular desk W. 180 x D. 80 cm	3 442 502	
	Curved desk W. 180 x D. 97 cm	3 442 503	
<b>Desk with structural return unit (can be placed on left or right-hand side)</b>			
	Rectangular desk W. 182 x D. 160 cm	3 442 504	
	Rectangular desk W. 202 x D. 160 cm	3 442 505	
	Curved desk W. 202 x D. 177 cm	3 442 506	
	Optional sliding door	3 442 359 + MU	
<b>Panoramic desks. Desk configuration comprising a 90° corner angle and a rectangular desk W. 80 cm</b>			
	Rectangular desk W. 240 x D. 160 cm	3 442 507	
	Rectangular desk W. 260 x D. 160 cm	3 442 508	
	Curved desk W. 260 cm x D. 177 cm	3 442 509	
<b>Corner angle unit</b>			
	90° angle worktop	3 442 112	
	Tubular leg Ø 60 mm in Aluminium grey finish (support leg required upwards of 20 kg expected loads)	3 442 370 + SB	

## EASY-REACH STORAGE

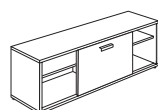

### Storage unit with sliding doors

Unit incorporating a median vertical partition and 2 half-width shelves

3 442 510 + top + MU

### Mobile melamine pedestals

2 drawers

3 442 113 + top + SB

3 drawers

3 442 114 + top + SB

**Power and cable management**  
 Optional - see page 273

## THE KEY TO PERFORMANCE AND WELL-BEING

Whether destined to be used by several people, or an individual, the shared workstation for collaborative work is a key element in ensuring the well-being of employees.

Sit-stand desks allow users to alternate their working stance throughout the day and are therefore the ideal solution to promote continued dynamic engagement and comfort.

Choose AXEL or ESSENTIEL UP and equip yourself with the ideal response to this emerging working mode.

Fixed height desks, for their part, must offer a range of ergonomic configurations, complemented by ingenious storage solutions to guarantee comfort at work.

CONNECT is the expression of these new solutions, thanks to its highly modular design and structural storage components.

Finally, ARIAL provides a workable shared workstation desking solution to meet the needs of tighter budgets.

## Sit-stand desks

AXEL .....	58
ESSENTIEL UP .....	64

## Fixed height desks

CONNECT .....	68
ARIAL .....	80
IDOL .....	86
FORSTYL .....	94

new

# AXEL

---

Health and well-being are of paramount concern to organisations. In order to promote movement and avoid sedentary habits, AXEL allows you to switch from sitting to standing positions throughout the day, thereby improving your comfort levels and well-being at work.





- Desktop screens, page 99
- Multi-compartment storage unit, page 131
- Ergonomic chairs, page 195
- Decorative plants, page 253



# Adjustable & ergonomic

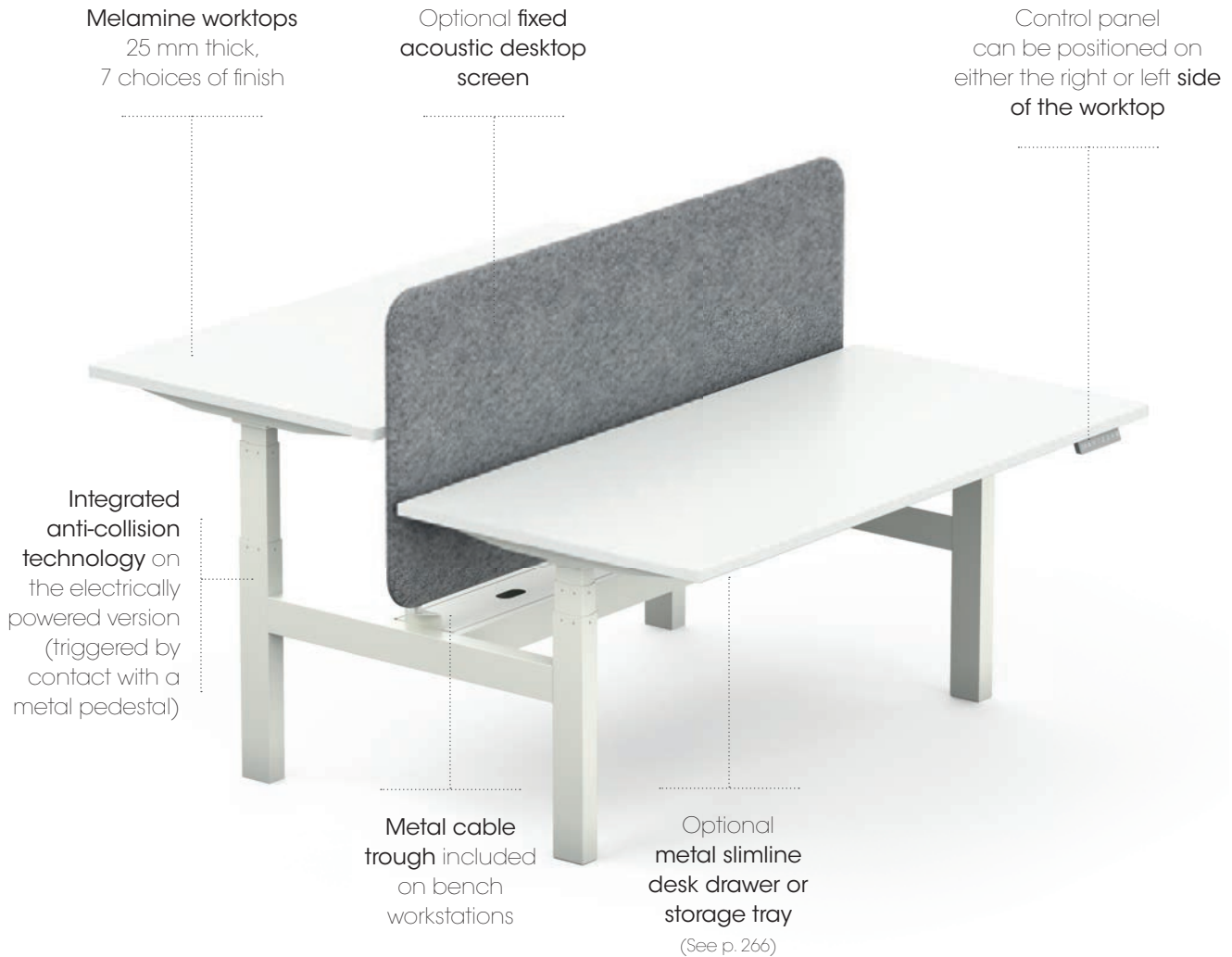

Melamine worktops  
25 mm thick,  
7 choices of finish

Optional fixed  
acoustic desktop  
screen

Control panel  
can be positioned on  
either the right or left side  
of the worktop

Integrated  
anti-collision  
technology on  
the electrically  
powered version  
(triggered by  
contact with a  
metal pedestal)

Metal cable  
trough included  
on bench  
workstations

Optional  
metal slimline  
desk drawer or  
storage tray  
(See p. 266)

## 2 TYPES OF ADJUSTMENT SYSTEM



Manual adjustment by hand lever  
(stows away under worktop):  
adjusts from 71.5 to 117 cm  
(individual desk) and from 71.5  
to 116 cm (bench shared desk).  
Centred perimeter leg comprising  
2 telescopic shafts



Powered by an electric motor  
with a built-in digital control panel,  
4 preset memory positions,  
between 65 and 130 cm.  
Centred perimeter leg comprising  
3 telescopic shafts, with 1 motor  
to each leg

# FINISHES & PRODUCT OVERVIEW

7

choices of melamine worktop (+ top)

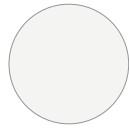

**MG**  
Snow white



**M6**  
Cashmere grey



**MA**  
White maple



**R2**  
Honfleur beech wood



**R1**  
Light oak



**R3**  
Brunswick oak



**RL**  
Amber walnut

FROM STOCK

3

choices of metal finish for legs (+ fin.)

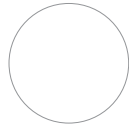

**SO**  
White



**Z4**  
Silver grey



**SG**  
Black

FROM STOCK

2

choices of fabric colour for desktop screens (+ fab.)



3 shade cards for fabrics



Bondai (Cat. A), Xtreme CS (Cat. B) and Blazer (Cat. D) see page 283

ON REQUEST

3

choices of metal finish for clamps (+ fin.)

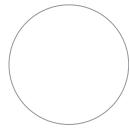

**SO**  
White



**SA**  
Aluminium grey



**SG**  
Black

FROM STOCK

ON REQUEST: 4 weeks (desktop screens) 6 weeks (desks)

## Individual desks

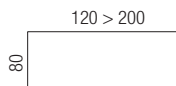
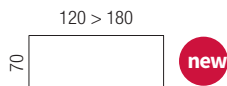

## Desks with shared structural frame

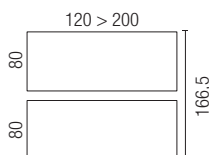

## Acoustic desktop screens H. 70 cm for Bench AXEL workstations

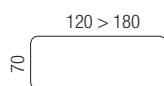

## Power and cable management

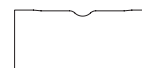

# PRICES

Price excl. taxes: **From stock** **On request**

**Hand lever operated height-adjustment**  
Height-adjustable desk from 71.5 to 117 cm



**Power assisted height adjustment**  
Height-adjustable desk from 65 to 130 cm.  
Control panel with 4 positions memory



## INDIVIDUAL DESKS

Ref. + top + fin.

Ref. + top + fin.

### D. 70 cm

> **Rectangular worktops with pre-drilled openings for cable ports** (sold separately)



W. 120 cm	1 532 120
W. 140 cm	1 532 121
W. 160 cm	1 532 122
W. 180 cm	1 532 123

1 532 137
1 532 138
1 532 139
1 532 140

> **Rectangular worktops with scallop edge.** MG and RI finishes available from stock.

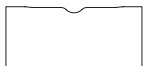

W. 120 cm	-
W. 140 cm	-
W. 160 cm	-

1 532 141
1 532 142
1 532 143

> **Rectangular worktops with pre-cut openings for soft closing top access housings** (sold separately - see p. 275).  
Metal cable trough included, in a matching finish to legs.



W. 120 cm	1 532 131
W. 140 cm	1 532 132
W. 160 cm	1 532 133

1 532 144
1 532 145
1 532 146

### D. 80 cm

> **Rectangular worktops with pre-drilled openings for cable ports** (sold separately). Desk W. 200 cm is mounted on a W. 180 cm structural frame.



W. 120 cm	1 532 020
W. 140 cm	1 532 021
W. 160 cm	1 532 022
W. 180 cm	1 532 023
W. 200 cm	1 532 024

1 532 050
1 532 051
1 532 052
1 532 053
1 532 054

> **Rectangular worktops with scallop edge.** MG and RI finishes available from stock.



W. 120 cm	-
W. 140 cm	-
W. 160 cm	-
W. 180 cm	-

1 532 096
1 532 097
1 532 098
1 532 099

> **Rectangular worktops with pre-cut openings for soft closing top access housings** (sold separately - see p. 275).  
Metal cable trough included, in a matching finish to legs. MG and RI finishes available from stock.



W. 120 cm	1 532 157
W. 140 cm	1 532 158
W. 160 cm	1 532 159
W. 180 cm	1 532 160

1 532 055
1 532 056
1 532 057
1 532 058

(See page 277 for upper cable troughs)



**Power and cable management**  
Optional - See page 273



**Top access housing**  
Module to be ordered separately - see p. 275

**Hand lever operated height-adjustment**  
Height-adjustable desks, from 71.5 to 116 cm  
Twin compartment cable trough included



**Power assisted height adjustment**  
Height-adjustable desks, from 65 to 130 cm. Control panel with 4 positions memory. Twin compartment cable trough included.



DESKS WITH  
SHARED STRUCTURAL FRAME

Ref. + top + fin.	Ref. + top + fin.
-------------------	-------------------

**D. 80 cm / D. 166.5 cm**

> 2 rectangular worktops with pre-drilled openings for cable ports (sold separately). Desk W. 200 cm is mounted on a W. 180 cm structural frame.

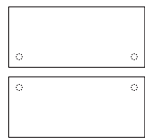

W. 120 cm	1 532 025	1 532 059
W. 140 cm	1 532 026	1 532 060
W. 160 cm	1 532 027	1 532 061
W. 180 cm	1 532 028	1 532 062
W. 200 cm	1 532 029	1 532 063

> 2 rectangular worktops with scallop edge. MG and RI finishes available from stock.

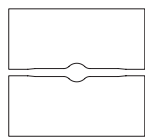

W. 120 cm	-	1 532 100
W. 140 cm	-	1 532 101
W. 160 cm	-	1 532 102
W. 180 cm	-	1 532 103

> 2 rectangular worktops with pre-cut openings for soft closing top access housings (sold separately - see p. 275).  
Each worktop is fitted with its own metal cable trough, in a matching finish to legs. MG and RI finishes available from stock.

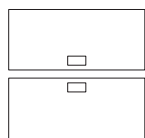

W. 120 cm	1 532 161	1 532 064
W. 140 cm	1 532 162	1 532 065
W. 160 cm	1 532 163	1 532 066
W. 180 cm	1 532 164	1 532 067

OPTIONS

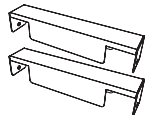

**Set of 2 spacing bars for shared workstations** (powered version).  
These create a space between adjoining desks in order to prevent the accidental trapping of fingers during worktop height adjustments. Attach to the desk structure. Available in a choice of White SO, Aluminium grey SA or Black SG (+ fin.).

Ref. + fin.

1 532 114

Bondai fabrics  
(Cat. A)

Xtreme CS fabrics  
(Cat. B)

Blazer fabrics  
(Cat. D)

DESKTOP SCREENS

Ref. + fab.

> For desks with a shared structural frame

**Acoustic desktop screens H. 70 cm : specially designed for AXEL workstations**

Outer frame made from aluminium covered with fabric - Core made from honeycomb cardboard 25 mm thick, clad with 1 layer of 10 mm thick acoustic polyester fibre on each panel face. 47 mm thick. Tackable panel surface. Mounted on the desk structural frame using fixing clamps, sold separately. Not designed to receive an accessories rail.



W. 120 cm	1 532 007
W. 140 cm	1 532 008
W. 160 cm	1 532 009
W. 180 cm	1 532 010

**Fixing clamps.** Must be included in your order.

Epoxy lacquered metal clamps - Choice of finish in White SO, Aluminium grey SA or Black SG (+fin.).

Clamps for screens H. 70 cm	1 532 012
-----------------------------	-----------

> For individual desks, see the complete desktop screen offering on p. 99.

FINISHES

Choice of melamine finish for worktops (+ top)



Choice of metal finish for legs (+ fin.)



Choice of fabric colour (+ fab.)



Choices of metal finish for clamps (+ fin.)



FROM STOCK

ON REQUEST

FROM STOCK

ON REQUEST: 4 weeks (desktop screens) 6 weeks (desks)

# ESSENTIEL UP

Exemplifying the current shifting trend towards sit-stand desks, Essentiel UP allows a user to effortlessly alternate working positions throughout the day, thanks to its electrically powered lift mechanism. Essentiel UP is a cost-effective desking solution bringing together user comfort with a clean design.



- Cupboards, page 121
- Ergonomic chairs, page 195
- Desktop lamps, page 253
- Decorative plants, page 253
- Cable and Power management, page 273



## Economical & ergonomic

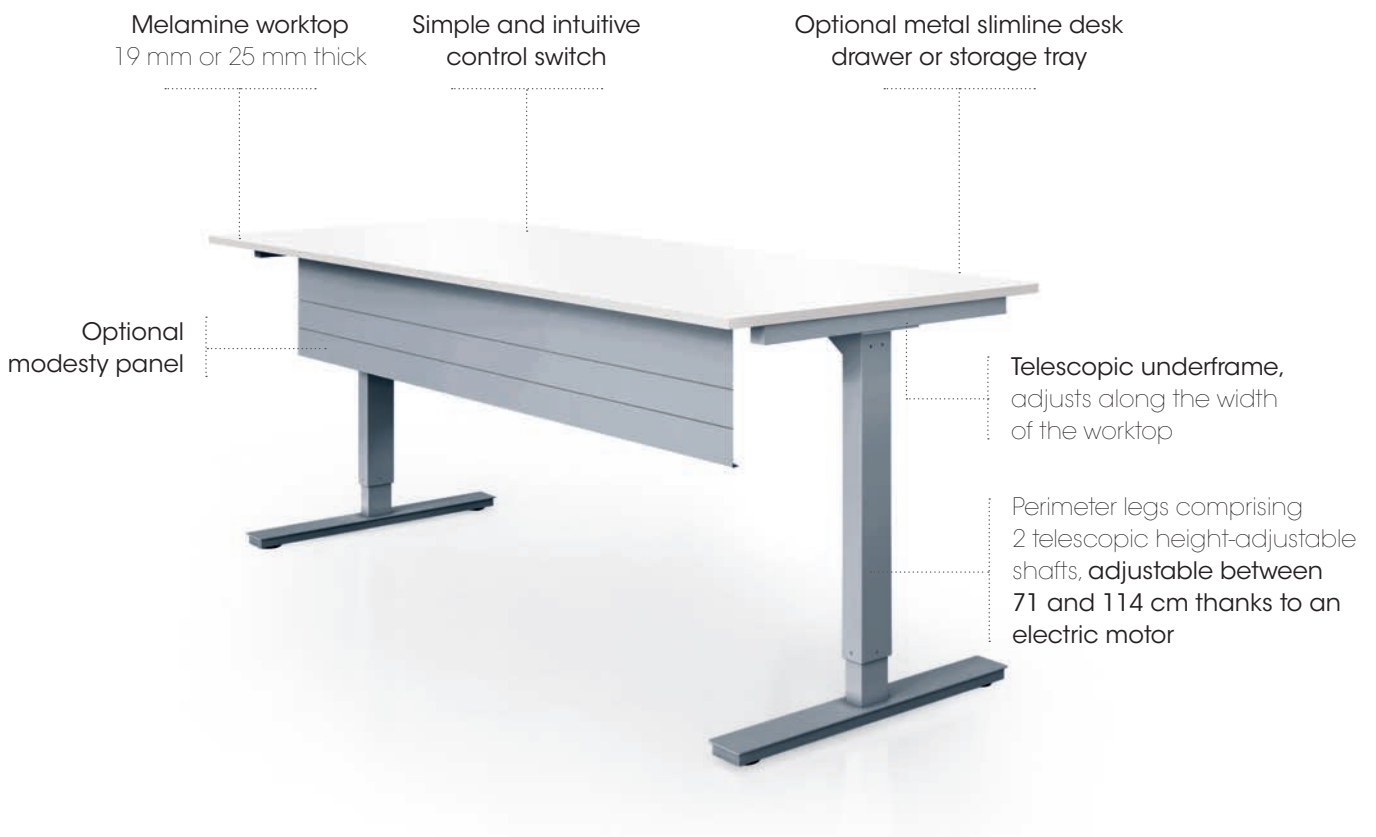

### ADJUSTMENTS



Height-adjustment  
control switch

### OPTIONS



Optional slimline  
desk drawer  
(See page 266)



Rotatable  
storage tray  
made from ABS

# FINISHES & PRODUCT OVERVIEW

2

choices of melamine finish for 19 mm thick worktops (+ top)



FROM STOCK

7

choices of melamine finish for 25 mm thick worktops (+ top)



FROM STOCK

3

choices of metal finish for legs (+ fin.)



FROM STOCK

ON REQUEST: allow 6 weeks

Rectangular worktops 19 mm thick

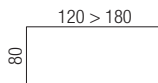

Rectangular worktops 25 mm thick

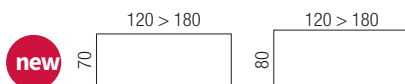

Power and cable management

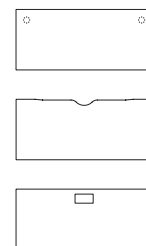

# PRICES

Price excl. taxes: **From stock**  **On request**

**PLAIN worktops**



**Worktops with SCALLOP EDGE**



**Worktops for ABS Top Access HOUSING MODULES\*** (See p. 275)  
Metal cable trough included



## INDIVIDUAL DESKS

### Worktops 19 mm thick

> D. 80 cm

	Ref. + top + fin.		Ref. + top + fin.		Ref. + top + fin.	
W. 120 cm	1 618 020		-		1 618 037	
W. 140 cm	1 618 015		-		1 618 038	
W. 160 cm	1 618 016		-		1 618 039	
W. 180 cm	1 618 017		-		1 618 040	

**Worktops to receive optional CABLE PORTS**



**Worktops with SCALLOP EDGE**  
(Choice of MG and RI finishes from stock)



**Worktops to receive SOFT CLOSING HOUSING MODULES\*** (See p. 275)  
Metal cable trough included  
(Choice of MG and RI finishes from stock)



### Worktops 25 mm thick

> D. 70 cm

	Ref. + top + fin.		Ref. + top + fin.		Ref. + top + fin.	
W. 120 cm	1 618 064		1 618 068		1 618 071	
W. 140 cm	1 618 065		1 618 069		1 618 072	
W. 160 cm	1 618 066		1 618 070		1 618 073	
W. 180 cm	1 618 067		-		-	

> D. 80 cm

	Ref. + top + fin.		Ref. + top + fin.		Ref. + top + fin.	
W. 120 cm	1 618 025		1 618 088		1 618 050	
W. 140 cm	1 618 026		1 618 089		1 618 051	
W. 160 cm	1 618 027		1 618 090		1 618 052	
W. 180 cm	1 618 028		1 618 091		1 618 053	



**Power and cable management**  
Optional - see page 273



**Top access housing**  
Module to be ordered separately - see p. 275

\*Different top access housing modules dependent on worktop thickness.

## FINISHES

Choice of melamine finish for 19 mm thick worktops (+ top)



MG



RI



MG



M6



MA



R2



RI



R3



RL

Choice of metal finish for legs (+ fin.)



SO



Z4



SG

FROM STOCK

**ON REQUEST: allow 6 weeks**

# CONNECT

Thanks to its one-piece construction metal structure, CONECT caters fully to the current trend for shared spaces that promote communication and proximity. With its angular lines and clean aesthetic design, CONECT sits comfortably within modern collaborative work environments. Additionally, a desk frame that sits slightly apart from the worktop confers a sense of lightness to this expansive desk.



Workstation comprising 4 rectangular desks resting on a shared structural storage unit. Bridge design legs.



- Accessory rails, page 99
- Cupboards, page 121
- Ergonomic chairs, page 195

2 workstations each comprising 2 shared structure rectangular desks, bridge legs and socket feed housings.  
Individual tower pedestals.



- Desktop screens, page 99
- Pedestals and multi-compartment storage units, page 121
- Ergonomic chairs, page 195
- Accessories, page 253



# Timeless & versatile

Individual desks  
D. 70 or 80 cm  
Desks with shared structural frame  
D. 142 or 165 cm

Power and cable  
management solutions:  
cable ports, recess in worktop  
or top access housing

Melamine worktops  
25 mm thick  
(7 choices of finish).



Desk height structural  
storage units, 2 sliding  
doors with the option  
of adding a counter top  
storage unit.

## 3 TYPES OF LEG DESIGN



Fixed height  
rectangular  
bridge leg  
H. 73.5 cm



Fixed height  
rectangular  
frame leg  
H. 73.5 cm



Height-adjustable  
rectangular  
bridge leg  
H. 62 to 86 cm

# FINISHES

7

choices of melamine worktop (+ top)



FROM STOCK

7

choices of metal finish for legs (+ fin.)

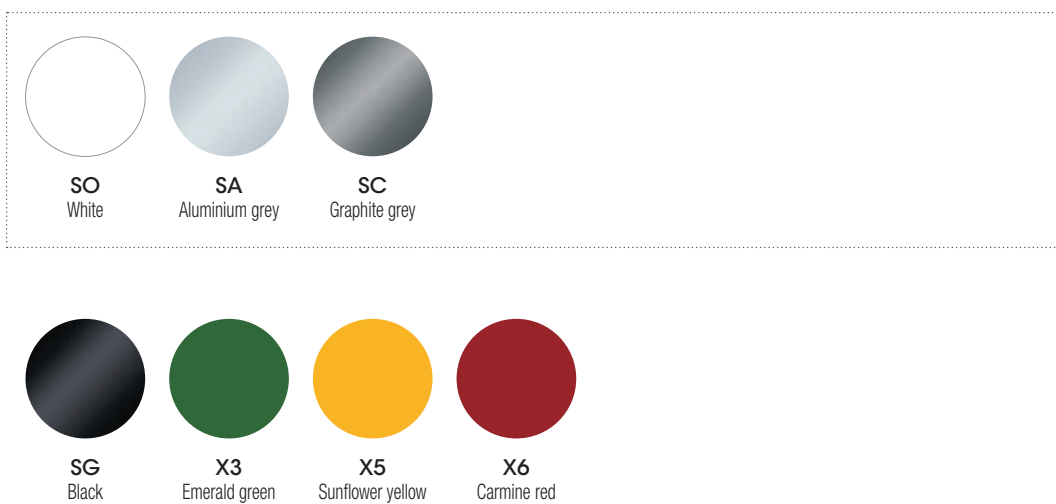

FROM STOCK

ON REQUEST

(.5%)

10

choices of melamine door colour (+ col.1)

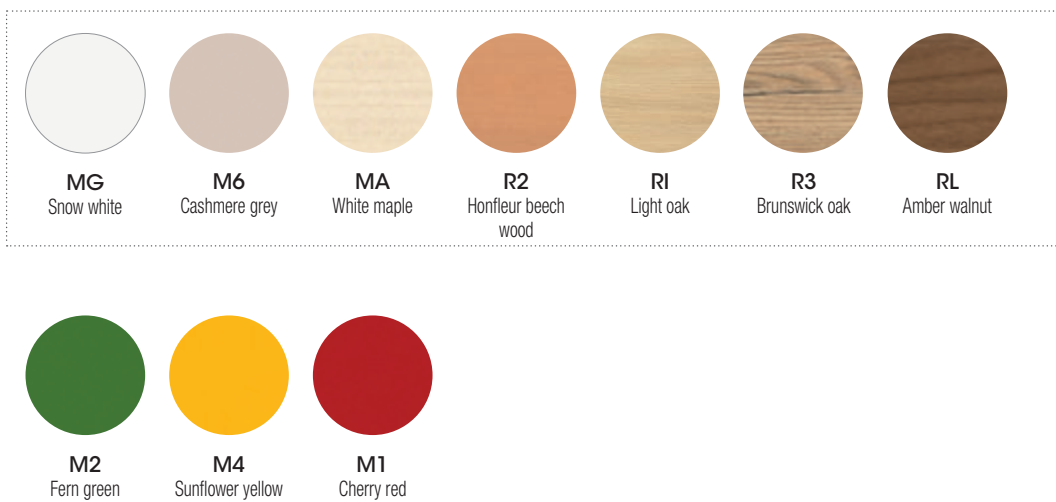

FROM STOCK

ON REQUEST

(.5%)

ON REQUEST: allow 6 weeks

# OVERVIEW

## Individual desks

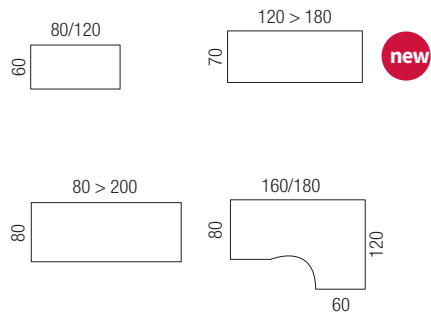

## Individual desks with storage units

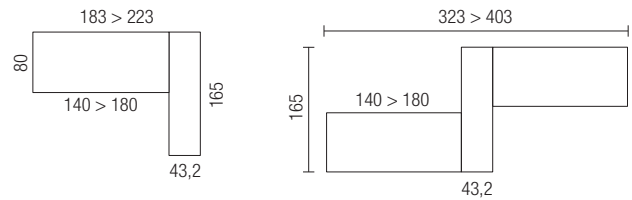

## Desks with shared structural frame

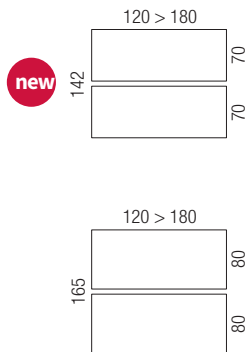

## Desks with shared structural frame and storage units

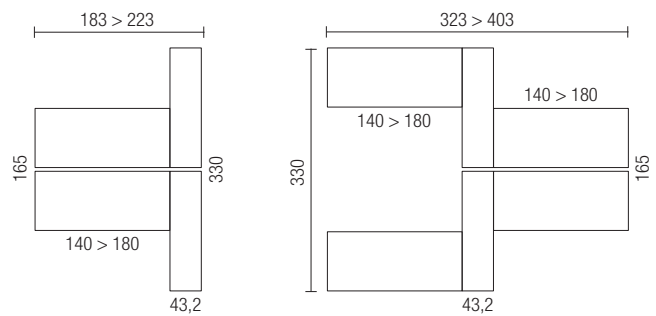

## Extension units

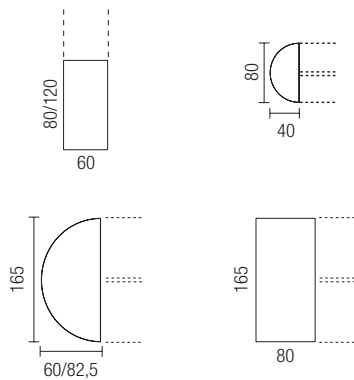

## Power and cable management

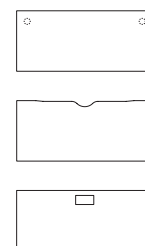

# PRICES

Price excl. taxes: **From stock** **On request**

Fixed height rectangular bridge legs



Fixed height rectangular frame legs



HA\* rectangular bridge legs



## INDIVIDUAL DESKS

### D. 60 cm

#### > Rectangular desks (without cable port openings)



W. 80 cm 1 171 128

W. 120 cm 1 171 129

1 171 191

1 171 192

1 171 267

1 171 268

### D. 70 cm

#### > Rectangular worktops with pre-drilled openings for cable ports (sold separately - see p. 275)



W. 120 cm 1 172 474

W. 140 cm 1 172 475

W. 160 cm 1 172 476

W. 180 cm 1 172 477

1 172 495

1 172 496

1 172 497

1 172 498

1 172 499

1 172 500

1 172 501

1 172 502

#### > Rectangular worktops with scallop edge. From stock availability in MG and RI finish only.



W. 120 cm 1 172 486

W. 140 cm 1 172 487

W. 160 cm 1 172 488

1 172 503

1 172 504

1 172 505

1 172 506

1 172 507

1 172 508

#### > Rectangular worktops with pre-cut openings for soft closing top access housings (see p. 275). Metal cable trough included, in a matching finish to legs.



W. 120 cm 1 173 297

W. 140 cm 1 173 298

W. 160 cm 1 173 299

1 173 306

1 173 307

1 173 308

1 173 309

1 173 310

1 173 311

### D. 80 cm

#### > Rectangular worktops with pre-drilled openings for cable ports (sold separately)

##### Starter unit



W. 80 cm 1 171 001

W. 120 cm 1 171 002

W. 140 cm 1 171 003

W. 160 cm 1 171 004

W. 180 cm 1 171 005

W. 200 cm 1 171 825

1 171 195

1 171 196

1 171 197

1 171 198

1 171 199

1 171 188

1 171 261

1 171 262

1 171 263

1 171 264

1 171 265

1 171 266

#### Add-on (the add-on desk unit adapts to all types of fixed height leg structures) Intermediary leg on the user side is set back.



W. 120 cm 1 172 567

W. 140 cm 1 172 568

W. 160 cm 1 172 569

W. 180 cm 1 172 570



**Power and cable management**  
Optional - see page 273



**Top access housing**  
Module to be ordered separately - see page 275

\* HA: Height-adjustable



INDIVIDUAL DESKS

D. 80 cm

> Rectangular worktops with scallop edge. From stock availability in MG and RI finish only.

Starter unit

	W. 120 cm	1 172 341		1 172 370		1 172 563	
	W. 140 cm	1 172 342		1 172 371		1 172 564	
	W. 160 cm	1 172 343		1 172 372		1 172 565	
	W. 180 cm	1 172 344		1 172 373		1 172 566	

Add-on (the add-on desk unit adapts to all types of fixed height leg structures) Intermediary leg on the user side is set back

	W. 120 cm	1 172 571	
	W. 140 cm	1 172 572	
	W. 160 cm	1 172 573	
	W. 180 cm	1 172 574	

> Rectangular worktops with pre-cut openings for soft closing top access housings (See p. 275). Metal cable trough included, in a matching finish to legs.

From stock availability in MG and RI finish only.

Starter unit

	W. 120 cm	1 173 873		1 173 342		1 173 293	
	W. 140 cm	1 173 874		1 173 343		1 173 294	
	W. 160 cm	1 173 875		1 173 344		1 173 295	
	W. 180 cm	1 173 876		1 173 345		1 173 296	

Add-on (the add-on desk unit adapts to all types of fixed height leg structures) Intermediary leg on the user side is set back.

	W. 120 cm	1 173 346	
	W. 140 cm	1 173 347	
	W. 160 cm	1 173 348	
	W. 180 cm	1 173 349	

> 90° asymmetrical compact desks D. 80/120 x return 60 cm. Worktops with pre-drilled openings for cable ports (sold separately - see p. 275)

	<b>W. 160 cm</b>					
	Return on left side	1 171 053		1 171 567		1 171 417
	Return on right side	1 171 054		1 171 568		1 171 418
		<b>W. 180 cm</b>				
Return on left side		1 171 156		1 171 569		1 171 419
Return on right side		1 171 157		1 171 570		1 171 420

FINISHES

Choice of melamine finish for worktops (+ top)      Choice of metal finish for legs (+ fin.)      Choice of melamine doors colour (+ col.1)

FROM STOCK      ON REQUEST      ON REQUEST      ON REQUEST

ON REQUEST: allow 6 weeks

# PRICES

Price excl. taxes: **From stock** **On request**

## INDIVIDUAL DESKS

### > Extension units

> **Rectangular returns mounted on legs D. 60 cm.** Can be positioned on either the left or right-hand side of rectangular desks and on the return of asymmetrical compact desks.

		Fixed height rectangular bridge legs	Fixed height rectangular frame legs	HA* rectangular bridge legs
	W. 80 cm	1 171 061	1 171 595	1 171 383
	W. 120 cm	1 171 175	1 171 596	1 171 384

> **Returns mounted on structural pedestals D. 60 cm x W. 42 cm.**

Metal pedestal with 2 box drawers and 1 suspension file drawer - Available in a choice of White SO, Aluminium grey SB and Graphite grey SC finish.

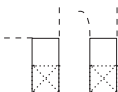
	W. 80 cm	1 171 111	
	W. 120 cm	1 171 113	

> **Half-moon worktop on support leg D. 40 cm.** Designed to be placed at the extremities of an individual desk D.80 cm Supported by 1 square section leg 60x60 mm.

	W. 80 cm fixed height leg	1 171 178	
	W. 80 cm height-adjustable leg	1 171 180	

## INDIVIDUAL DESKS

### > With easy reach structural storage unit

Ref. + top + fin. + col. 1

Ref. + top + fin. + col. 1

**Examples of layouts/configurations (contact us for information on alternative configurations and finishes)**

Melamine sliding doors - Front user side or two-sided access. Desk height storage unit shell available in a White MG or Aluminium grey MU finish, matching the corresponding White SO and Aluminium grey SA legs finish. Option to add a countertop storage unit with Altuglas® sliding doors, sold separately.

**Workstation configured around a rectangular desk D. 80 cm with desk height storage unit - fixed height legs.**

Worktops with pre-drilled openings for cable ports (sold separately). The desk height return can be positioned to the left or right-hand side of the main work surface.

#### > Front side user access with sliding doors

#### Bridge design legs

#### Frame design legs

W. 183 x D. 165 cm (Worktop 140 cm)

1 171 229

1 171 237

W. 203 x D. 165 cm (Worktop 160 cm)

1 171 230

1 171 238

W. 223 x D. 165 cm (Worktop 180 cm)

1 171 231

1 171 239

#### > Two-sided user access with sliding doors

W. 183 x D. 165 cm (Worktop 140 cm)

1 171 617

1 171 620

W. 203 x D. 165 cm (Worktop 160 cm)

1 171 618

1 171 621

W. 223 x D. 165 cm (Worktop 180 cm)

1 171 619

1 171 622

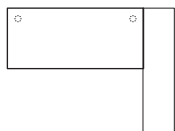

**Central storage unit - 2 rectangular worktops D. 80 cm with desk height storage - fixed height legs.**

Worktops with pre-drilled openings for cable ports (sold separately). Pair of worktops assembled either side of the central storage unit.

#### > Two-sided user access with sliding doors

#### Bridge design legs

#### Frame design legs

W. 323 x D. 165 cm (Worktop 140 cm)

1 171 489

1 171 505

W. 363 x D. 165 cm (Worktop 160 cm)

1 171 490

1 171 506

W. 403 x D. 165 cm (Worktop 180 cm)

1 171 491

1 171 507

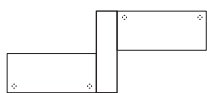

**Power and cable management**  
Optional - See page 273



**Top access housing**  
Module to be ordered separately - see page 275

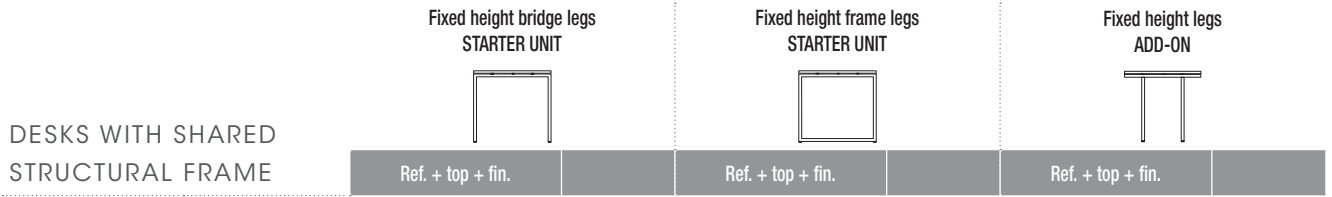

**D. 142 cm (2 rectangular worktops D. 70 cm)**

> Worktops with pre-drilled openings for cable ports (sold separately).

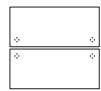

W. 120 cm	1 172 516
W. 140 cm	1 172 517
W. 160 cm	1 172 518
W. 180 cm	1 172 519

**STARTER** (2 perimeter legs)



1 172 520
1 172 521
1 172 522
1 172 523

**ADD-ON** (1 intermediary support leg)



1 172 524
1 172 525
1 172 526
1 172 527

> Worktops with scallop edge. From stock availability in MG and RI finish only.

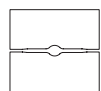

W. 120 cm	1 172 536
W. 140 cm	1 172 537
W. 160 cm	1 172 538

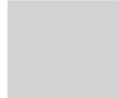

1 172 539
1 172 540
1 172 541

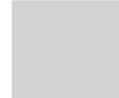

1 172 542
1 172 543
1 172 544

> Pre-cut worktops with openings for soft closing top access housings (See p. 275). Twin compartment metal cable trough included, in a matching finish to legs. 

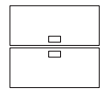

W. 120 cm	1 173 315
W. 140 cm	1 173 316
W. 160 cm	1 173 317

1 173 318
1 173 319
1 173 320

1 173 321
1 173 322
1 173 323

**D. 165 cm (2 rectangular worktops D. 80 cm)**

> Worktops with pre-drilled openings for cable ports (sold separately).

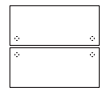

W. 120 cm	1 171 021
W. 140 cm	1 171 022
W. 160 cm	1 171 023
W. 180 cm	1 171 024



1 171 245
1 171 246
1 171 247
1 171 248



1 171 033
1 171 034
1 171 035
1 171 036

> Worktops with scallop edge. From stock availability in MG and RI finish only.

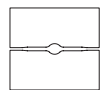

W. 120 cm	1 172 357
W. 140 cm	1 172 358
W. 160 cm	1 172 359
W. 180 cm	1 172 360



1 172 353
1 172 354
1 172 355
1 172 356



1 172 365
1 172 366
1 172 367
1 172 368

> Pre-cut worktops with openings for soft closing top access housings (See p. 275). Twin compartment metal cable trough included, in a matching finish to legs. 

From stock availability in MG and RI finish only.

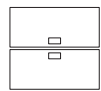

W. 120 cm	1 173 921
W. 140 cm	1 173 922
W. 160 cm	1 173 923
W. 180 cm	1 173 924



1 173 350
1 173 351
1 173 352
1 173 353



1 173 929
1 173 930
1 173 931
1 173 932

**Optional intermediary support leg.**

Ref. + fin.

> Metal panel on intermediary leg for shared bench workstation (starter/add-on). In a matching finish to legs. Facilitates routing of cables down from the worktop.



Set of 2 panels

2 403 835



**FINISHES**

Choice of melamine finish for worktops (+ top)



Choice of metal finish for legs (+ fin.)

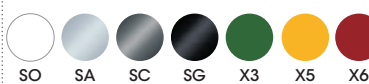

Choice of melamine doors colour (+ col.1)

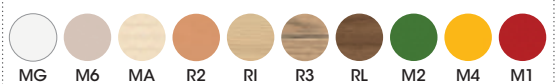

FROM STOCK

5%

FROM STOCK

5%

ON REQUEST: allow 6 weeks

ON REQUEST ON REQUEST

ON REQUEST

# PRICES

Price excl. taxes: **From stock** **On request**

## DESKS WITH SHARED STRUCTURAL FRAME > Extension units

Fixed height rectangular bridge legs



Ref. + top + fin.

Fixed height rectangular frame legs



Ref. + top + fin.

**Rectangular worktop.** Rectangular worktop designed to be placed at the extremity of shared structure workstations D. 165 cm



W. 165 x D. 80 cm

1 171 957

1 171 436

**Half-moon worktop on support legs.** Designed to be placed at the extremity of shared structure workstations D. 165 cm. Supported by 2 square section legs 60 x 60 mm for the D. 82.5 cm and 1 leg for D. 60 cm



W. 165 x D. 60 cm

Square fixed leg(s)

1 171 063

Square height-adjustable leg(s)

1 171 174

W. 165 x D. 82.5 cm

1 171 179

1 171 181

## DESKS WITH SHARED STRUCTURAL FRAME > With easy reach structural storage units

Ref. + top + fin. + col. 1

Ref. + top + fin. + col. 1

**Examples of layouts/configurations (contact us for information on alternative configurations and finishes).**

Melamine sliding doors - Front user side or two-sided access. Desk height storage unit shell available in a White MG or Aluminium grey MU finish, matching the corresponding White SO and Aluminium grey SA legs finish. The desk height return can be positioned to the left or right-hand side of the main work surface. Option to add a countertop storage unit with Altuglas® sliding doors, sold separately.

> **Central storage unit - 4 rectangular worktops D. 80 cm with desk height storage. Worktops with pre-drilled openings for cable ports (sold separately).**  
2 individual worktops assembled to one side of the central storage unit and a further 2 shared structure worktops assembled to the other side.

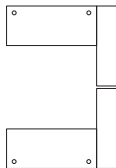

Two-sided user access with sliding doors

Bridge design legs

Frame design legs

W. 323 x D. 330 cm (Worktop 140 cm)

1 171 497

1 171 513

W. 363 x D. 330 cm (Worktop 160 cm)

1 171 498

1 171 514

W. 403 x D. 330 cm (Worktop 180 cm)

1 171 499

1 171 515

> **Desks with shared structural frame - 2 rectangular worktops D. 80 cm with desk height storage units.**  
1 fixed height Bridge or Frame design perimeter leg and 2 desk height structural returns.

Worktops with pre-drilled openings for cable ports (sold separately).

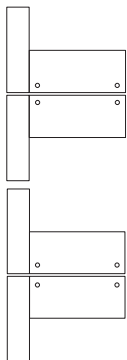

Front side user access

Bridge design legs

Frame design legs

W. 183 x D. 330 cm (Worktop 140 cm)

1 171 397

1 171 445

W. 203 x D. 330 cm (Worktop 160 cm)

1 171 398

1 171 446

W. 223 x D. 330 cm (Worktop 180 cm)

1 171 399

1 171 447

Two-sided user access

W. 183 x D. 330 cm (Worktop 140 cm)

1 171 405

1 171 453

W. 203 x D. 330 cm (Worktop 160 cm)

1 171 406

1 171 454

W. 223 x D. 330 cm (Worktop 180 cm)

1 171 407

1 171 455

Fixed height rectangular bridge legs



Ref. + top + fin. + col. 1

Fixed height rectangular frame legs



Ref. + top + fin. + col. 1

Pre-cut worktops with openings for soft closing top access housings (See p. 275). Twin compartment metal cable trough included, in a matching finish to legs. From stock availability in MG and RI finish only.



Front side user access

W. 183 x D. 330 cm (Worktop 140 cm)

1 173 965

1 173 354

W. 203 x D. 330 cm (Worktop 160 cm)

1 173 966

1 173 355

W. 223 x D. 330 cm (Worktop 180 cm)

1 173 967

1 173 356

Two-sided user access

W. 183 x D. 330 cm (Worktop 140 cm)

1 173 971

1 173 357

W. 203 x D. 330 cm (Worktop 160 cm)

1 173 972

1 173 358

W. 223 x D. 330 cm (Worktop 180 cm)

1 173 973

1 173 359

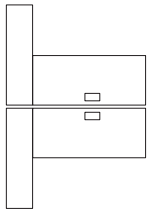

ACCESSORIES FOR EASY REACH STRUCTURAL STORAGE UNITS

Ref. + col. 2 + fin. 1

Ref. + col. 2 + fin. 1

Counter top storage unit for desk height returns.

Melamine shell in a White MG or Aluminium grey MU finish (+fin. 1) - For all other colours: contact us for details. Altuglas® sliding doors (+ col. 2). To be placed on top of Desk Height returns - Front user side or two-sided access.

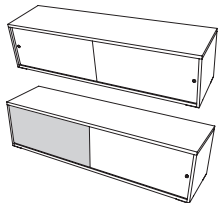

H. 42.5 x W. 165 x D. 43.2 cm

Front side user access

1 171 529

Two-sided user access

1 171 530

Choice of Altuglas® sliding door colour (+ col. 2)



FROM STOCK

ON REQUEST



Power and cable management

Optional - see page 273



Top access housing  
Module to be ordered separately - see page 275

FINISHES

Choice of melamine finish for worktops (+ top)



FROM STOCK

Choice of metal finish for legs (+ fin.)

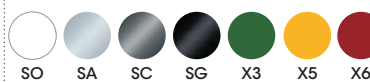

ON REQUEST ON REQUEST

Choice of melamine doors colour (+ col.1)



FROM STOCK

ON REQUEST

ON REQUEST: allow 6 weeks

# ARIAL

With its sleek styling and multiple power management solutions, the ARIAL range offers efficient and functional furnishing. Whether in the form of individual desks or shared workstations, ARIAL adapts perfectly to your needs while offering outstanding value for money.



- Desktop screens, page 99
- Pedestals, page 121
- Ergonomic chairs, page 195
- Desktop lamps, page 253



# Economical & functional

Multiple power and cable management solutions: cable ports, recess in worktop or top access housing

Melamine worktop  
19 mm thick (2 choices of finish)  
or 25 mm (7 choices of finish)

Fixed or height-adjustable desks



Optional modesty panel

## 3 TYPES OF LEG DESIGN



Fixed height semi-oblong bridge design legs  
H. 73.5 cm  
(25 mm thick)



Fixed height square bridge leg  
H. 73.5 cm  
(25 mm thick)



Height-adjustable square bridge leg  
H. 62 to 86 cm  
(25 mm thick)

# FINISHES & PRODUCT OVERVIEW

2 choices of melamine finish for 19 mm thick worktops (+ top)



FROM STOCK

7 choices of melamine finish for 25 mm thick worktops (+ top)



FROM STOCK

2 choices of metal finish for legs (+ fin.)

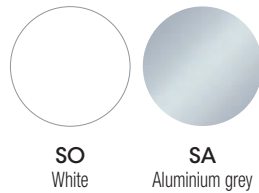

FROM STOCK

ON REQUEST: allow 6 weeks

## Individual desks

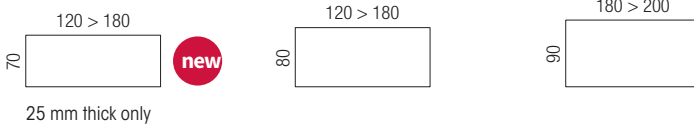

## Desks with shared structural frame



## Power and cable management

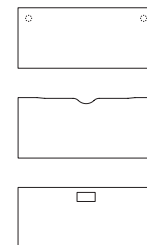

## Extension units

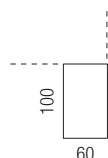

# PRICES

Price excl. taxes: **From stock** **On request**

Fixed height semi-oblong bridge legs

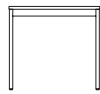

Fixed height square bridge legs



Height-adjustable square bridge legs

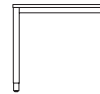

## INDIVIDUAL DESKS

### > Rectangular worktops

Ref. + top + fin.	Ref. + top + fin.	Ref. + top + fin.
-------------------	-------------------	-------------------

#### D. 70 cm - 25 mm thick worktops

##### > Worktops with pre-drilled openings for cable ports (sold separately).



W. 120 cm	2 370 170	2 370 174	2 370 178
W. 140 cm	2 370 171	2 370 175	2 370 179
W. 160 cm	2 370 172	2 370 176	2 370 180
W. 180 cm	2 370 173	2 370 177	2 370 181

##### > Worktops with scallop edge. From stock availability in MG and RI finish only.



W. 120 cm	2 370 182	2 370 185	2 370 188
W. 140 cm	2 370 183	2 370 186	2 370 189
W. 160 cm	2 370 184	2 370 187	2 370 190

##### > Worktops include a soft closing top access housing and a metal cable trough (both in a matching finish to legs).



W. 120 cm	2 370 191	2 370 194	2 370 197
W. 140 cm	2 370 192	2 370 195	2 370 198
W. 160 cm	2 370 193	2 370 196	2 370 199

#### D. 80 cm - 19 mm thick worktops

##### > Plain worktops



W. 120 cm	2 370 054	2 370 035	2 370 150
W. 140 cm	2 370 055	2 370 036	2 370 151
W. 160 cm	2 370 056	2 370 037	2 370 152
W. 180 cm	2 370 057	2 370 038	2 370 153

##### > Worktops include an ABS soft closing top access housing and a metal cable trough (both in a matching finish to legs).



W. 120 cm	2 370 067	2 370 066	2 370 154
W. 140 cm	2 370 058	2 370 039	2 370 155
W. 160 cm	2 370 059	2 370 040	2 370 156
W. 180 cm	2 370 060	2 370 041	2 370 157

#### D. 80 cm - 25 mm thick worktops

##### > Worktops with pre-drilled openings for cable ports (sold separately).



W. 120 cm	2 370 099	2 370 080	2 370 158
W. 140 cm	2 370 100	2 370 081	2 370 159
W. 160 cm	2 370 101	2 370 082	2 370 160
W. 180 cm	2 370 102	2 370 083	2 370 161

# PRICES

Price excl. taxes: **From stock** **On request**

Fixed height semi-oblong bridge legs

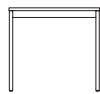

Fixed height square bridge legs



Height-adjustable square bridge legs

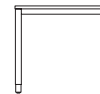

## INDIVIDUAL DESKS

### > Rectangular worktops

#### D. 80 cm - 25 mm thick worktops

> Worktops with scallop edge. From stock availability in MG and RI finish only.



W. 120 cm	2 370 218
W. 140 cm	2 370 219
W. 160 cm	2 370 220
W. 180 cm	2 370 221

2 370 222
2 370 223
2 370 224
2 370 225

2 370 226
2 370 227
2 370 228
2 370 229

> Worktops include a soft closing top access housing and a metal cable trough (both in a matching finish to legs). From stock availability in MG and RI finish only.



W. 120 cm	2 370 112
W. 140 cm	2 370 103
W. 160 cm	2 370 104
W. 180 cm	2 370 105

2 370 111
2 370 084
2 370 085
2 370 086

2 370 162
2 370 163
2 370 164
2 370 165

#### D. 90 cm - 19 mm thick worktops

> Plain worktops.



W. 180 cm	2 370 061
W. 200 cm	2 370 062

2 370 042
2 370 043

2 370 166
2 370 167

#### D. 90 cm - 25 mm thick worktops

> Worktops with pre-drilled openings for cable ports (sold separately). From stock availability in MG and RI finish only.



W. 180 cm	2 370 106
W. 200 cm	2 370 107

2 370 087
2 370 088

2 370 168
2 370 169

## DESKS WITH SHARED STRUCTURAL FRAME > SINGLE WORKTOP

#### D. 142 cm - 25 mm thick worktops

> Worktops with pre-drilled openings for cable ports (sold separately).

Starter unit



W. 120 cm	2 370 200
W. 140 cm	2 370 201
W. 160 cm	2 370 202

2 370 203
2 370 204
2 370 205

Add-on unit\*



W. 120 cm	2 370 206
W. 140 cm	2 370 207
W. 160 cm	2 370 208

> Worktops including 2 soft closing top access housings and a twin metal cable trough (all in a matching finish to legs). From stock availability in MG and RI finish only.

Starter unit



W. 120 cm	2 370 209
W. 140 cm	2 370 210
W. 160 cm	2 370 211

2 370 212
2 370 213
2 370 214

Add-on unit\*



W. 120 cm	2 370 215
W. 140 cm	2 370 216
W. 160 cm	2 370 217

\* The square section intermediary leg for the add-on workstation is compatible with both leg types.



DESKS  
SHARED STRUCTURAL FRAME

> Single worktop (continued)

Fixed height semi-oblong  
bridge legs

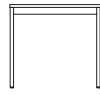

Fixed height square  
bridge legs



D. 165 cm - 19 mm thick worktops

> Plain worktops

			Ref. + top + fin.		Ref. + top + fin.	
Starter unit		W. 140 cm	2 370 070		2 370 051	
		W. 160 cm	2 370 071		2 370 052	
		W. 180 cm	2 370 072		2 370 053	

Add-on unit*		W. 140 cm	2 370 073			
		W. 160 cm	2 370 074			
		W. 180 cm	2 370 075			

> Worktops include 2 ABS soft closing top access housings and a twin metal cable trough (each in a matching finish to legs).

Starter unit		W. 140 cm	2 370 063		2 370 044	
		W. 160 cm	2 370 064		2 370 045	
		W. 180 cm	2 370 065		2 370 046	

Add-on unit*		W. 140 cm	2 370 047			
		W. 160 cm	2 370 048			
		W. 180 cm	2 370 049			

D. 165 cm - 25 mm thick worktops

> Worktops with pre-drilled openings for cable ports (sold separately).

Starter unit		W. 140 cm	2 370 115		2 370 096	
		W. 160 cm	2 370 116		2 370 097	
		W. 180 cm	2 370 117		2 370 098	

Add-on unit*		W. 140 cm	2 370 076			
		W. 160 cm	2 370 077			
		W. 180 cm	2 370 078			

> Worktops including 2 soft closing top access housings and a twin metal cable trough (all in a matching finish to legs). From stock availability in MG and RI finish only.

Starter unit		W. 140 cm	2 370 108		2 370 089	
		W. 160 cm	2 370 109		2 370 090	
		W. 180 cm	2 370 110		2 370 091	

Add-on unit*		W. 140 cm	2 370 092			
		W. 160 cm	2 370 093			
		W. 180 cm	2 370 094			

EXTENSION UNITS > Desk returns

D. 60 cm - Can be positioned to the left or right-hand side of the worktop. Includes 2 structural support legs with a semi-oblong or square cross-section.

	19 mm thick - W. 100 cm	2 370 069		2 370 050	
	25 mm thick - W. 100 cm	2 370 114		2 370 095	

\* The square section intermediary leg for the add-on workstation is compatible with both leg types.

FINISHES

Choice of melamine finish for 19 mm thick worktops (+ top)



Choice of melamine finish for 25 mm thick worktops (+ top)



Choice of metal finish for legs (+ fin.)



FROM STOCK

ON REQUEST: allow 6 weeks

# IDOL

IDOL is a highly versatile, effective and dynamic furnishing solution for work spaces. Its different structural frames, combined with a variety of worktop designs and optimised cable and power management, offer a host of solutions to meet the requirements of any office fit-out project.



90° asymmetrical compact desks. W. 180 cm with return on structural pedestal. Cantilever style legs with covered cable holders, melamine structural modesty panel. Worktop in a light oak decorative finish.



- Desktop screens, page 99
- Storage units, page 121
- Ergonomic chairs, page 195
- Desktop lamps, page 253
- Cable port hole covers, page 275



# Dynamic and diverse

Melamine worktop  
25 mm thick  
(7 choices of finish)

Worktops with  
pre-drilled openings  
for optional cable ports

Fixed or  
height-adjustable desks



Optional metal cable holder  
for fixed height legs, to facilitate cable  
routing to the feet

## 5 TYPES OF LEG DESIGN



Fixed height  
perimeter legs  
Optional cable holder  
H. 73.5 cm



HA\*  
perimeter legs  
Cable holder included  
H. 62 to 86 cm

\* HA : Height-adjustable



Fixed height  
cantilever legs  
Optional cable holder  
H. 73.5 cm





Fixed height  
cantilever legs  
Metal modesty panel  
Optional cable holder  
H. 73.5 cm



Fixed height  
cantilever legs  
Melamine modesty panel  
Optional cable holder  
H. 73.5 cm

# FINISHES & PRODUCT OVERVIEW

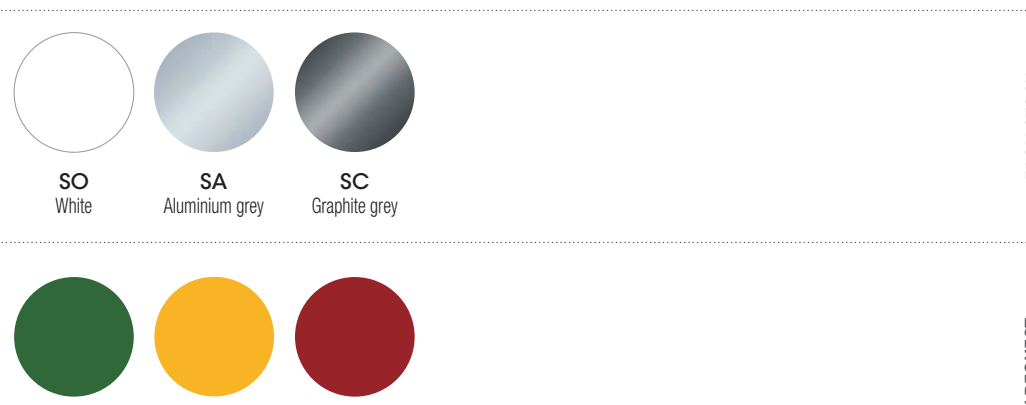
7	choices of melamine worktop finish (+ top)	 <p> <b>MG</b> Snow white    <b>M6</b> Cashmere grey    <b>MA</b> White maple    <b>R2</b> Honfleur beech wood    <b>RI</b> Light oak    <b>R3</b> Brunswick oak    <b>RL</b> Amber walnut         </p>	FROM STOCK
3	choices of metal finish for legs (+ fin.)	 <p> <b>SO*</b> White    <b>SA</b> Aluminium grey    <b>SC</b> Graphite grey         </p>	FROM STOCK
6	choices of metal colour for cable holders (+ col.)	 <p> <b>SO</b> White    <b>SA</b> Aluminium grey    <b>SC</b> Graphite grey  <b>X3</b> Emerald green    <b>X5</b> Sunflower yellow    <b>X6</b> Carmine red         </p>	FROM STOCK  ON REQUEST

\* allow max. 4 weeks for height-adjustable legs, in SO finish only.

ON REQUEST: allow 6 weeks

## Desks

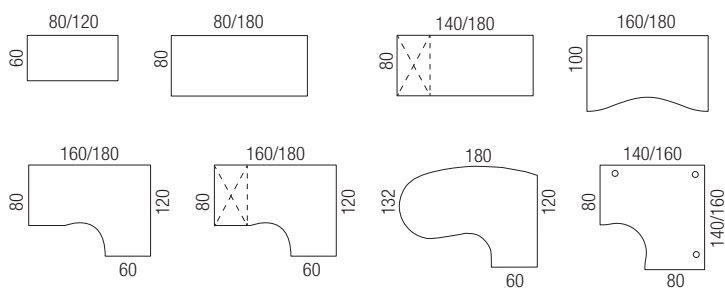

## Extension units

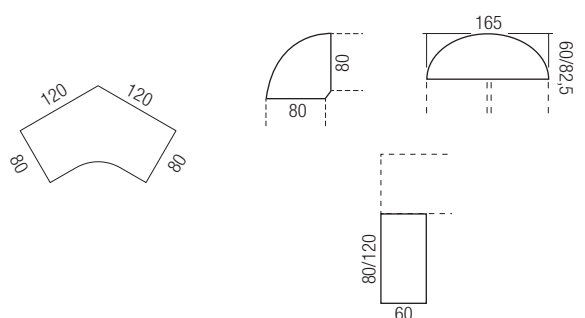

# PRICES

Price excl. taxes: **From stock** **On request**

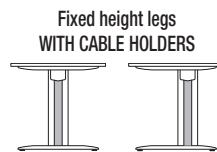
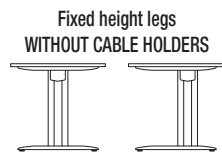

## RECTANGULAR DESKS

**D. 60 cm** - The worktops do not come pre-drilled for cable ports.



> Perimeter legs - Crossbeam

W. 80 cm	2 315 258		2 315 259		2 315 260	
W. 120 cm	2 315 066		2 315 067		2 315 068	

**D. 80 cm**

> Perimeter legs - Crossbeam

W. 80 cm	2 315 015		2 315 020		2 315 055	
W. 120 cm	2 315 016		2 315 021		2 315 056	
W. 140 cm	2 315 017		2 315 022		2 315 057	
W. 160 cm	2 315 018		2 315 023		2 315 058	
W. 180 cm	2 315 019		2 315 024		2 315 059	

> Cantilever legs - Crossbeam

W. 80 cm	2 315 025		2 315 030			
W. 120 cm	2 315 026		2 315 031			
W. 140 cm	2 315 027		2 315 032			
W. 160 cm	2 315 028		2 315 033			
W. 180 cm	2 315 029		2 315 034			



> Cantilever legs - Metal modesty panel

W. 80 cm	2 315 035		2 315 040			
W. 120 cm	2 315 036		2 315 041			
W. 140 cm	2 315 037		2 315 042			
W. 160 cm	2 315 038		2 315 043			
W. 180 cm	2 315 039		2 315 044			

> Cantilever legs - Melamine modesty panel

W. 80 cm	2 315 045		2 315 050			
W. 120 cm	2 315 046		2 315 051			
W. 140 cm	2 315 047		2 315 052			
W. 160 cm	2 315 048		2 315 053			
W. 180 cm	2 315 049		2 315 054			

## RECTANGULAR DESKS > With structural pedestal

**D. 80 cm** - Perimeter legs - Metal structural pedestal with 3 drawers D.80 x W. 42 cm. (Pedestal in a matching finish to the metallic finish of the legs).

Pedestal on the left

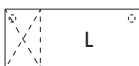

W. 140 cm	2 315 232		2 315 235			
W. 160 cm	2 315 233		2 315 236			
W. 180 cm	2 315 234		2 315 237			

Pedestal on the right

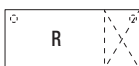

W. 140 cm	2 315 060		2 315 063			
W. 160 cm	2 315 061		2 315 064			
W. 180 cm	2 315 062		2 315 065			

## SYMMETRICAL WAVE DESKS

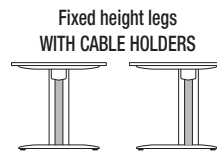
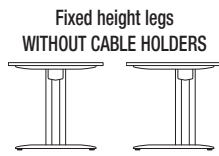

**D. 100 cm** - Availability from stock in MG and RI finish for W.180 cm

### > Perimeter legs - Crossbeam

W. 160 cm	2 315 072		2 315 074		2 315 088	
W. 180 cm	2 315 275		2 315 276		2 315 277	

### > Cantilever legs - Crossbeam

W. 160 cm	2 315 076		2 315 078			
W. 180 cm	2 315 278		2 315 279			



### > Cantilever legs - Metal modesty panel

W. 160 cm	2 315 080		2 315 082			
W. 180 cm	2 315 280		2 315 281			

### > Cantilever legs - Melamine modesty panel

W. 160 cm	2 315 084		2 315 086			
W. 180 cm	2 315 282		2 315 283			

## 90° ASYMMETRICAL COMPACT DESKS - RETURN 60 CM

In configurations that do not include a metal desk height structural pedestal, include an optional support leg.

### > Perimeter legs - Crossbeam

W. 160 cm gauche	2 315 104		2 315 108		2 315 136	
W. 160 cm droite	2 315 105		2 315 109		2 315 137	
W. 180 cm gauche	2 315 106		2 315 110		2 315 138	
W. 180 cm droite	2 315 107		2 315 111		2 315 139	

### > Cantilever legs - Crossbeam

W. 160 cm gauche	2 315 112		2 315 116			
W. 160 cm droite	2 315 113		2 315 117			
W. 180 cm gauche	2 315 114		2 315 118			
W. 180 cm droite	2 315 115		2 315 119			

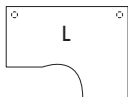

### > Cantilever legs - Metal modesty panel

W. 160 cm gauche	2 315 120		2 315 124			
W. 160 cm droite	2 315 121		2 315 125			
W. 180 cm gauche	2 315 122		2 315 126			
W. 180 cm droite	2 315 123		2 315 127			

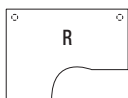

### > Cantilever legs - Melamine modesty panel

W. 160 cm gauche	2 315 128		2 315 132			
W. 160 cm droite	2 315 129		2 315 133			
W. 180 cm gauche	2 315 130		2 315 134			
W. 180 cm droite	2 315 131		2 315 135			

Ref. + fin.

**Tubular support leg (Ø 60 mm).** For configurations that do not include a metal desk height structural pedestal positioned alongside the return.

> Fixed height leg	2 315 070	
> Height-adjustable leg	2 315 071	

## FINISHES

Choice of melamine finish for worktops (+ top)



Choice of metal finish for legs (+ fin.)



Choice of metal colour for cable holders (+ col.)



FROM STOCK

5%

ON REQUEST: allow 6 weeks

\* allow max. 4 weeks for height-adjustable legs, in SO finish only.

ON REQUEST

# PRICES

Price excl. taxes: **From stock** **On request**

## 90° ASYMMETRICAL COMPACT DESKS - RETURN 60 CM

> With structural pedestal

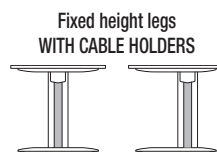
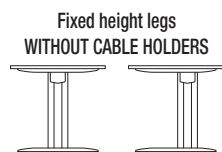

**Perimeter legs.** Metal structural pedestal with 3 drawers D. 80 x W. 42 cm (Pedestal in a matching finish to the metallic finish of the legs).

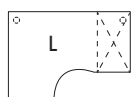

**Return on left side**

W. 160 cm	2 315 140		2 315 144	
W. 180 cm	2 315 141		2 315 145	



**Return on right side**

W. 160 cm	2 315 142		2 315 146	
W. 180 cm	2 315 143		2 315 147	

## 90° COMPACT CONVIVIAL DESKS W. 180 X RT. 60 CM

**Tubular support leg included on return side.** Brunswick oak R3 finish available exclusively on request.

**Perimeter legs - Crossbeam**

Return on left side	2 315 148		2 315 150		2 315 164	
Return on right side	2 315 149		2 315 151		2 315 165	

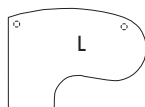

**Cantilever legs - Crossbeam**

Return on left side	2 315 152		2 315 154	
Return on right side	2 315 153		2 315 155	

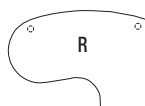

**Cantilever legs - Metal modesty panel**

Return on left side	2 315 156		2 315 158	
Return on right side	2 315 157		2 315 159	

**Cantilever legs - Melamine modesty panel**

Return on left side	2 315 160		2 315 162	
Return on right side	2 315 161		2 315 163	

## 90° COMPACT SYMMETRICAL DESKS X RT. 80 CM ASYMMETRICAL STRUCTURE

**Perimeter legs - Crossbeam**

**Return on left side**

W. 140 x W. 140 cm	2 315 166		2 315 170
W. 160 x W. 160 cm	2 315 284		2 315 286

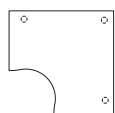

**Return on right side**

W. 140 x W. 140 cm	2 315 167		2 315 171
W. 160 x W. 160 cm	2 315 285		2 315 287

## 120° COMPACT SYMMETRICAL DESKS X RT. 80 CM SYMMETRICAL STRUCTURE

**Perimeter legs - Crossbeam.** Brunswick oak R3 finish available exclusively on request.



W. 120 x W. 120 cm	2 315 190		2 315 191
--------------------	-----------	--	-----------

## RECTANGULAR FIXED RETURNS

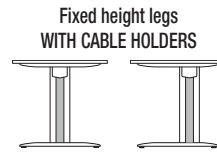
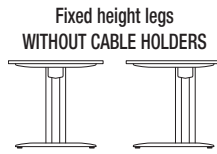

Ref. + top + fin.

Ref. + top + fin.+ col.

Ref. + top + fin.

**D. 60 cm** - Combine with rectangular desks and asymmetrical compact desks, on the desk return side.

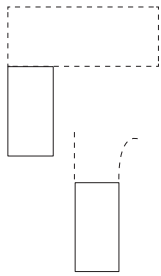

### Perimeter legs - Return on left-hand side

W. 80 cm 2 315 261

W. 120 cm 2 315 197

### Perimeter legs - Return on right-hand side

W. 80 cm 2 315 264

W. 120 cm 2 315 229

### On static metal structural pedestal

W. 80 cm 2 315 201

W. 120 cm 2 315 200

2 315 262

2 315 198

2 315 265

2 315 230

2 315 263

2 315 199

2 315 266

2 315 231

## HALF-MOON TABLE W. 165 CM

Combine with rectangular desks D. 80 cm. Circular fixed or height-adjustable leg Ø 60 mm. 1 support leg for D. 60 cm and 2 support legs for D. 82.5 cm.

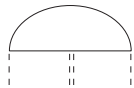

### Fixed height leg(s)

D. 60 cm 2 315 193

D. 82,5 cm 2 315 194

### Height-adjustable leg(s)

2 315 195

2 315 196

## 90° CORNER ANGLE UNIT

Ref. + top

**D. 80 cm** - To join 2 individual worktops. Support leg required for expected loads exceeding 20 kg.

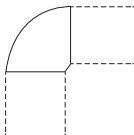

90° corner angle 2 315 069

Ref. + fin.

**Tubular support leg (Ø 60 mm).** For configurations that do not include a metal desk height structural pedestal positioned alongside the return.

> Fixed height leg 2 315 070

> Height-adjustable leg 2 315 071

## FINISHES

Choice of melamine finish for worktops (+ top)



Choice of metal finish for legs (+ fin.)



Choice of metal colour for cable holders (+ col.)



FROM STOCK

5%

ON REQUEST : allow 6 weeks

\* allow max. 4 weeks for height-adjustable legs, in SO finish only.

ON REQUEST

# FORSTYL

Thanks to its 'L' shaped or panel leg designs, FORSTYL offers functional and ergonomic workstation configurations. It is the perfect solution for tighter budgets looking for a simple and visually appealing solution.



- Pedestals, page 121
- Ergonomic chairs, page 195
- Desktop accessories, page 253



# Functional & economical

Melamine worktop  
25 mm thick,  
(4 choices of finish)

Worktop with pre-drilled  
openings  
for optional cable ports

Fixed height desks  
H. 73.5 cm

Structural melamine  
modesty panels in a  
matching finish to the  
worktopworktop

2 cable outlets



## 2 TYPES OF LEG DESIGN



Panel legs  
H. 73.5 cm



L shaped leg  
with metal base  
H. 73.5 cm

# FINISHES & PRODUCT OVERVIEW

4 choices of melamine worktop (+ top)



5 choices of melamine leg (+ top 2)



1 choice of metal finish for legs

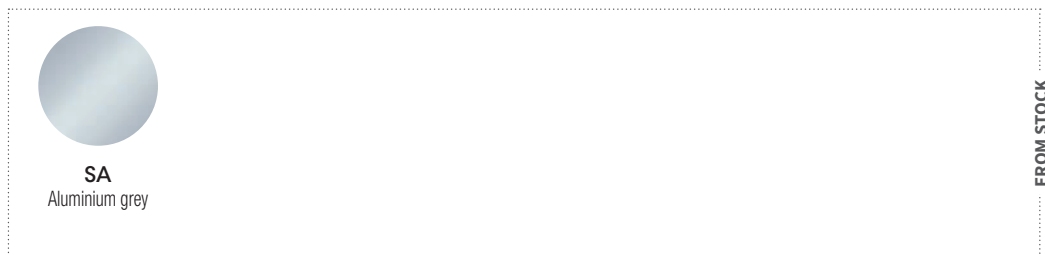

Individual desks

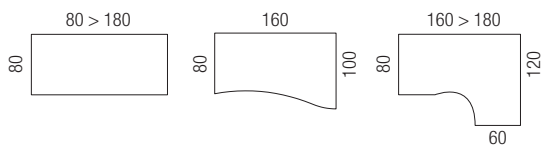

Extension units

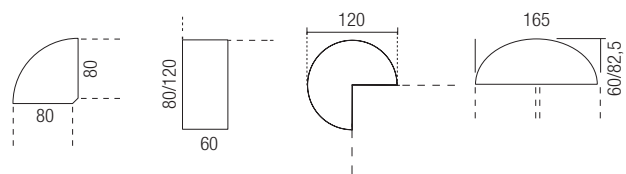

# PRICES

Price excl. taxes : **From stock** **On request**

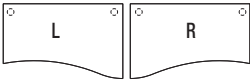
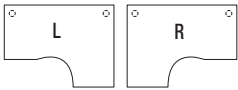
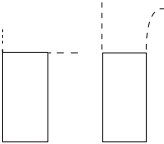
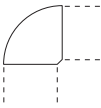
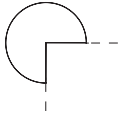
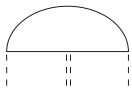
		PANEL legs		L shaped legs	
		Ref. + top + top 2		Ref. + top + top 2	
<b>RECTANGULAR DESKS D. 80 CM</b>					
	W. 80 cm	2 057 300		2 057 255	
	W. 120 cm	2 057 301		2 057 256	
	W. 140 cm	2 057 302		2 057 257	
	W. 160 cm	2 057 303		2 057 258	
	W. 180 cm	2 057 304		2 057 259	
<b>ASYMMETRICAL WAVE DESKS D. 80/100 CM</b>					
	W. 160 cm - Return on left-hand side	2 057 309		2 057 265	
	W. 160 cm - Return on right-hand side	2 057 310		2 057 266	
<b>90° ASYMMETRICAL COMPACT DESKS - RETURN 60 CM</b>					
Tubular support leg Ø 60 mm in Aluminium grey finish included under the desk return.					
	W. 160 cm - Return on left-hand side	2 057 305		2 057 275	
	W. 160 cm - Return on right-hand side	2 057 306		2 057 276	
	W. 180 cm - Return on left-hand side	2 057 307		2 057 277	
	W. 180 cm - Return on right-hand side	2 057 308		2 057 278	
<b>FIXED RETURN D. 60 CM</b>					
Allows the joining of 2 individual worktops D. 80 cm. Support leg required for expected loads exceeding 20 kg. Tubular leg Ø 60 mm in Aluminium grey finish.					
	W. 80 cm	2 057 181			
	W. 120 cm	2 057 182			
<b>90° CORNER ANGLE UNIT D. 80 CM</b>					
Allows the joining of 2 individual worktops D. 80 cm. Support leg required for expected loads exceeding 20 kg. Tubular leg Ø 60 mm in Aluminium grey finish.					
		<b>For PANEL LEG desks</b>		<b>For desks with L shaped legs</b>	
	90° corner angle	2 057 135		2 057 136	
	Fixed tubular support leg	2 057 185 SA			
<b>DESK-END MEETING EXTENSION</b>					
Can be positioned on either the left or right-hand side of rectangular desks and on visitor side of asymmetrical compact desks. Tubular leg Ø 60 mm in Aluminium grey finish.					
		<b>For PANEL LEG desks</b>		<b>For desks with L shaped legs</b>	
	W. 120 x D. 120 cm	2 057 139		2 057 140	
<b>HALF-MOON TABLE W. 165 CM</b>					
Supported by 1 or 2 tubular legs Ø 60 mm in an Aluminium grey finish. Combine with all desks D. 80 cm.					
		<b>For PANEL LEG desks</b>		<b>For desks with L shaped legs</b>	
	D. 60 cm (1 leg)	2 057 158		2 057 161	
	D. 82.5 cm (2 legs)	2 057 159		2 057 162	

## OPTIMISE, DEFINE AND PERSONALISE YOUR SPACE

Open spaces greatly facilitate communications and interactions between employees. Yet, it is just as important for each member of staff to be able to define a space of their own, in order to promote concentration and work efficiently. To this end, desktop screens are essential for any workspace requiring an element of privacy. Purely decorative or with acoustic properties, they can also be accessorised to provide a personalised and clutter-free workspace. What is more, partitions help define areas for face-to-face interactions. SOLANGE's extensive choice of colours and gently curving profiles will enable you to structure the work space, whilst reducing ambient noise. Easy to combine, thanks to a practical and ingenious linking system, the partitions can also be mounted on castors which will facilitate the (re)configuration of work spaces to suit your needs.

## Desktop screens

ALTUGLAS® .....	100
TWINS .....	102

## Desktop and partition screens

SOLANGE .....	104
LUCIEN .....	112

Accessory rails .....	118
-----------------------	-----

# ALTUGLAS®

Altuglas® desktop screens are ideal for fitting out modern spaces that require partitioning, all the while allowing a subtle diffusion of ambient light. Available in several choices of finish, they lend a modern touch to your space.

**+** Modern & sober

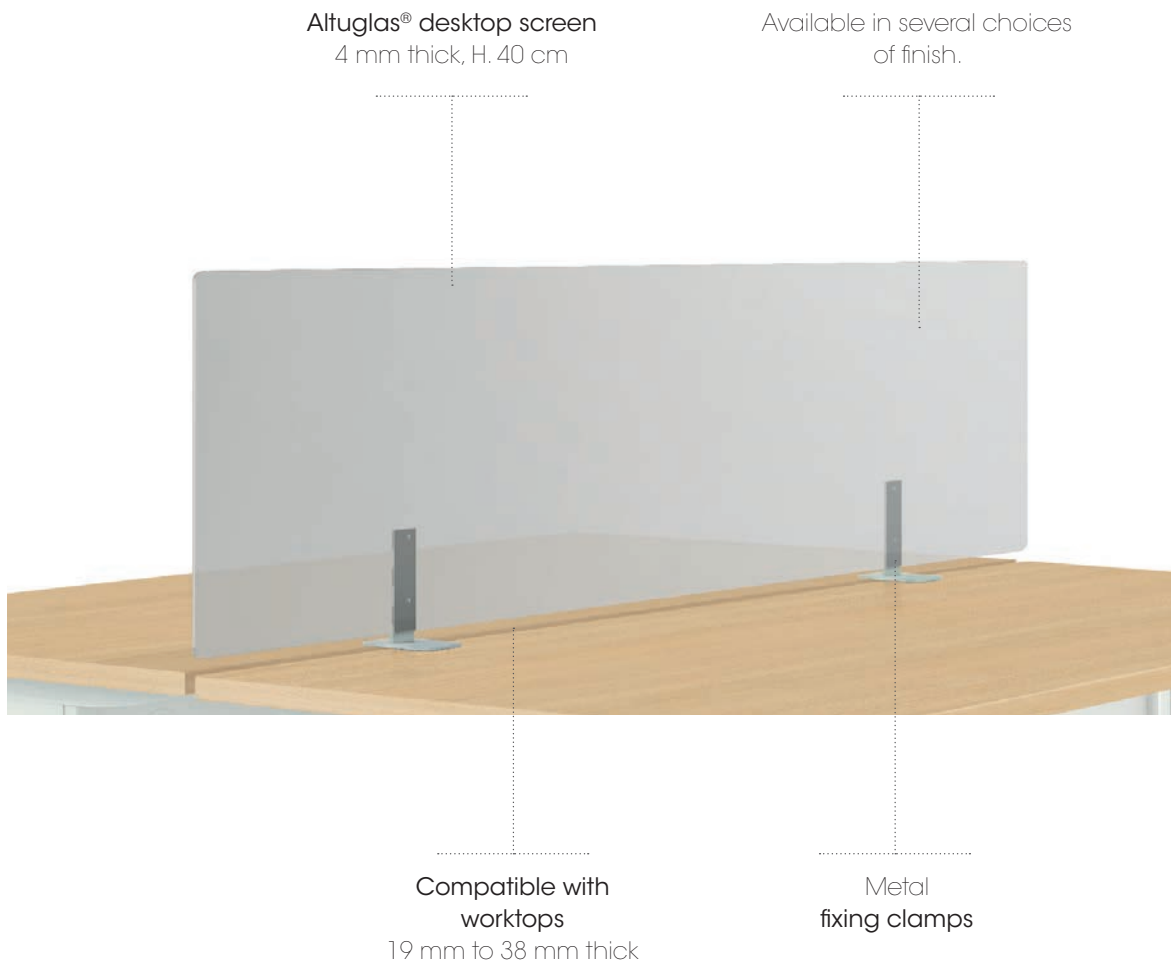

# PRICES

Price excl. taxes:

**From stock**

On request

## ALTUGLAS® DESKTOP SCREENS

Ref. + col.

To be mounted on workstations without a structural pedestal. For configurations incorporating a structural pedestal, contacts us for details. Screens W. 80 may also be mounted in lateral configurations. Complete with the addition of fixing clamps, ordered separately.

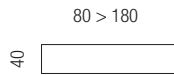

W. 80 cm	6 459 052
W. 120 cm	6 459 001
W. 140 cm	6 459 002
W. 160 cm	6 459 003
W. 180 cm	6 459 004

## FIXING CLAMPS



Ref. + fin.

Consist in flat shafts fixed to one side of the desktop screen. Secured using roundhead screws.

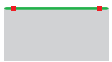

Clamps for individual workstations - frontal attachment

For worktops 19-25 mm thick 6 459 065

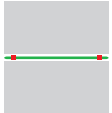

Clamps for twin workstations - face-to-face attachment

For worktops 28-38 mm thick 6 459 055



Clamps for lateral configurations

For worktops 19-38 mm thick 6 459 062

For worktops 19-25 mm thick 6 459 066

For worktops 28-38 mm thick 6 459 057

- Desktop screen
- Fixing clamps

## FINISHES

5 choices of Altuglas® (+ col.)



OA  
White



OB  
Smoked  
grey



O1  
Green



O4  
Yellow



OX  
Red

2 choices of metal finish for clamps (+ fin.)



SO  
White



SA  
Aluminium  
grey

FROM STOCK

ON REQUEST

-5%

ON REQUEST

FROM STOCK

ON REQUEST: allow 6 weeks



Fixing clamps to be ordered separately  
Must be included in your order

# TWINS

+ The ideal solution to suit every budget

Corners to the top edge  
are rounded

Accessories  
rail

Metal  
fixing clamps

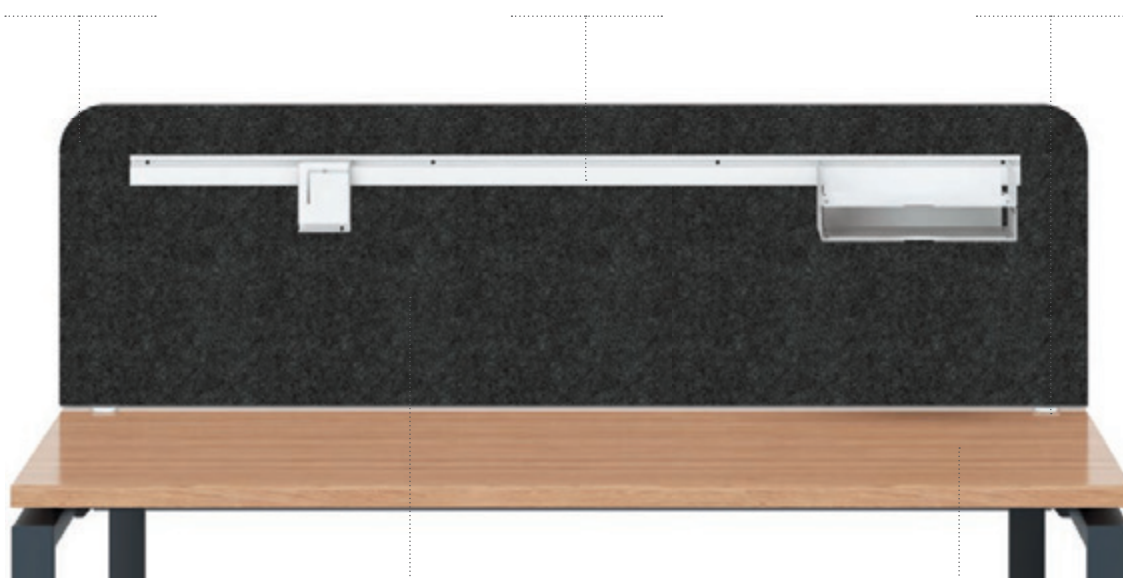

Available in melamine (19 mm thick)  
or fabric (25 mm thick)  
H. 40 cm

Compatible  
with worktops  
19 mm to 30 mm thick

## HOW TO PLACE AN ORDER ?

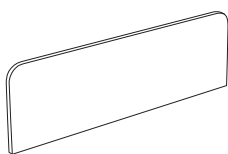

1. Choose  
a **DESKTOP SCREEN**

+



2. Select the necessary **FIXING CLAMPS**  
for a chosen configuration

+

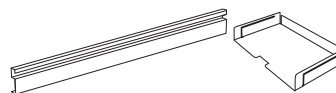

3. Complete your selection by adding an optional  
**RAIL** and corresponding **ACCESSORIES**



Fixing clamps  
to be ordered separately  
Must be included in your order

# PRICES

Price excl. taxes: **From stock** **On request**

Bondai fabrics (Cat. A) Xtreme CS fabrics (Cat. B) Blazer fabrics (Cat. D)

## FABRIC COVERED DESKTOP SCREENS

Desktop screens H. 40 cm - 25 mm thick - Complete with the addition of fixing clamps, ordered separately.

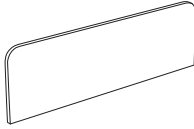

W. 80 cm	6 712 007
W. 100 cm	6 712 008
W. 120 cm	6 712 009
W. 140 cm	6 712 010
W. 160 cm	6 712 011
W. 180 cm	6 712 012

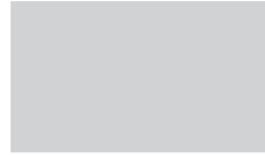

## MELAMINE DESKTOP SCREENS

Desktop screens H. 40 cm - 19 mm thick - Complete with the addition of fixing clamps, ordered separately.

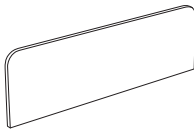

W. 80 cm	6 712 001
W. 100 cm	6 712 002
W. 120 cm	6 712 003
W. 140 cm	6 712 004
W. 160 cm	6 712 005
W. 180 cm	6 712 006

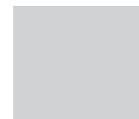

## FIXING CLAMPS



Clamps made from lacquered epoxy steel. Choice of finish in White SO or Aluminium grey SA - Compatible with worktops 19 mm to 30 mm thick.

**Individual workstations - frontal attachment**

6 712 013

For individual workstations positioned face-to-face or bench desks with shared structural frame and 2 worktops - attachment to both tops

6 712 014

**Single worktop desks with shared structural frame - bolt-through attachment** - 2 options :

- Choose a screen that is 40 cm shorter than the width of the worktop.
- Choose a screen of the same width as the desk worktop.

6 712 015



## OPTIONS

**Accessories rail** - Made from lacquered epoxy steel. Designed to be placed on TWINS desktop screens. Drilling template provided for the melamine version. White drill point markers featured on the fabric version.

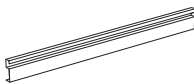

Rail W. 56 cm for desktop screen W. 80 cm	6 459 029
Rail W. 76 cm for desktop screen W. 100 cm	6 459 024
Rail W. 96 cm for desktop screen W. 120 cm	6 459 025
Rail W. 116 cm for desktop screen W. 140 cm	6 459 026
Rail W. 136 cm for desktop screen W. 160 cm	6 459 027
Rail W. 156 cm for desktop screen W. 180 cm	6 459 028



**Pueblo accessories** - Made from lacquered epoxy steel. Designed to be placed on the accessories rail. May also be placed directly on the work surface (except 3 slot diagonal sorting tray).

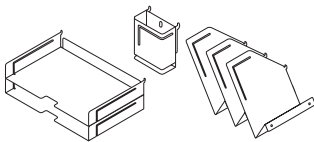

Letter tray - starter W. 33.5 x D. 22 x H. 5 cm	7 521 001
Letter tray - add-on W. 33.5 x D. 22 x H. 5 cm	7 521 002
Pencil cup - W. 8.4 x D. 3.8 x H. 10 cm	7 521 003
3 slot diagonal sorting tray - W. 38.5 x D. 22 x H. 23.5 cm	7 521 004



## FINISHES

6 choices of melamine finish (+ fin)

4 choices of fabric colour (+ fab.)

2 choices of clamp, rail and accessories colour finish (+ fin.)

<p>MG White</p> <p>M6 Cashmere grey</p> <p>RI Light oak</p> <p>M2 Green</p> <p>M4 Yellow</p> <p>M1 Cherry red</p>	<p>Bondai (Cat. A)</p> <p>Xtreme CS (Cat. B)</p> <p>Cat. A, B, D</p> <p>KG Aubergine</p> <p>U4 Light grey</p> <p>V6 Saffron yellow</p> <p>W5 Green brown</p>	<p>SO White</p> <p>SA Aluminium grey</p>
FROM STOCK	FROM STOCK	FROM STOCK
ON REQUEST	ON REQUEST	ON REQUEST

ON REQUEST: allow 4 weeks

5%

# SOLANGE

SOLANGE desktop screens and partitions allow for the creation of private areas within a larger shared workspace, favouring concentration. Thanks to their highly effective sound absorption qualities, these acoustic screens and partitions significantly reduce the disruptive impact of ambient noise, whilst at the same time providing an aesthetically harmonious backdrop to the workspace.



- Shared workstations, page 57
- Ergonomic chairs, page 195



## Clever & soundproofing

SOLANGE acoustic desktop screens absorb up to **50%** of nuisance ambient noise.

Source :  
CEDIA laboratory  
(Belgium)

Acoustic desktop screen  
47 mm thick, H. 40 and 70 cm

+ 30 choices  
of fabrics

Optional hanging  
rail and accessories

Functional and  
aesthetically pleasing  
screw-on buttons on  
either side of the screen

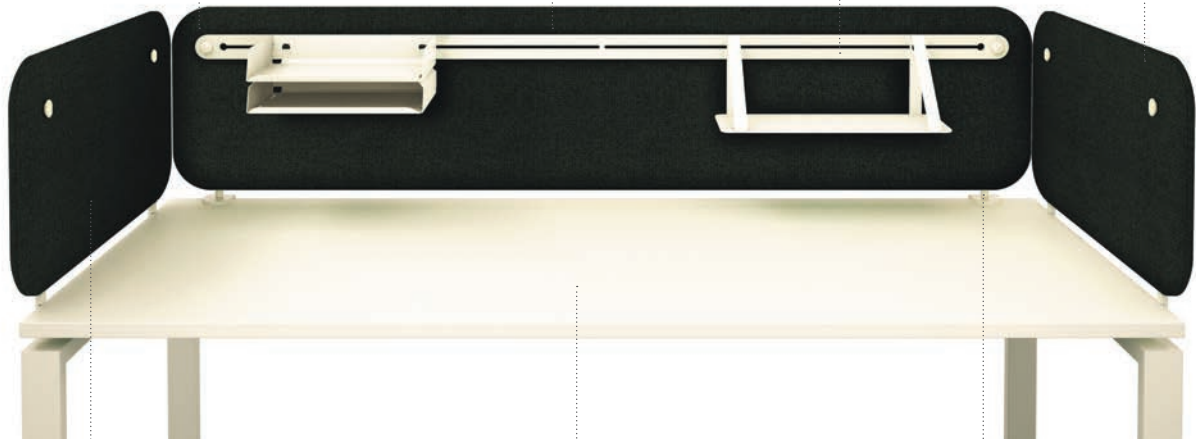

Available as a lateral  
screen H. 40 cm

Compatible with  
worktops  
19 to 30 mm thick

Metal fixing clamps  
available in a choice  
of 4 colours



## Tool-free assembly



Available in a full fabric-covered version or part fabric, part translucent PMMA version

Different stabilizer feet models depending on the chosen configuration: fixed or mobile partitions, in individual or multi-partition configurations

Available in standard and acoustic versions 47 mm thick

### OPTIONS



Intelligent linking system



Whiteboard with pen tray

# FINISHES & PRODUCT OVERVIEW

4 choices of fabrics (+ fab.)

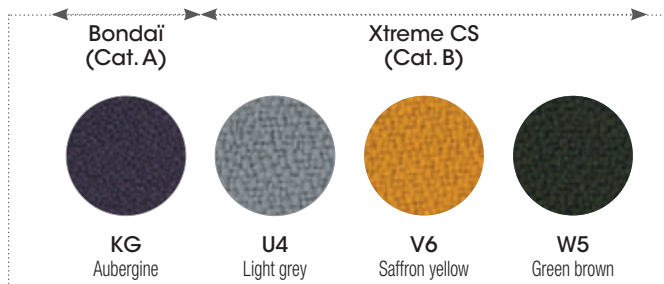

3 shade cards for fabrics

Bondai (Cat. A), Xtreme CS (Cat. B) and Blazer (Cat. D) see page 283

ON REQUEST

4 choices of metal finish for legs and clamps (+ fin.)\*

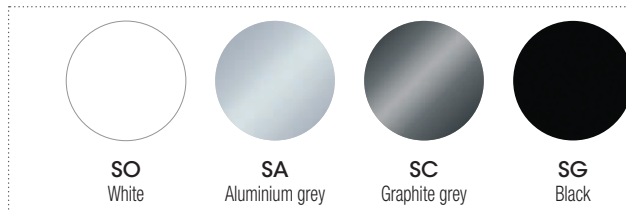

FROM STOCK

7 choices of metal colour finish for rail and accessories (+ fin.)

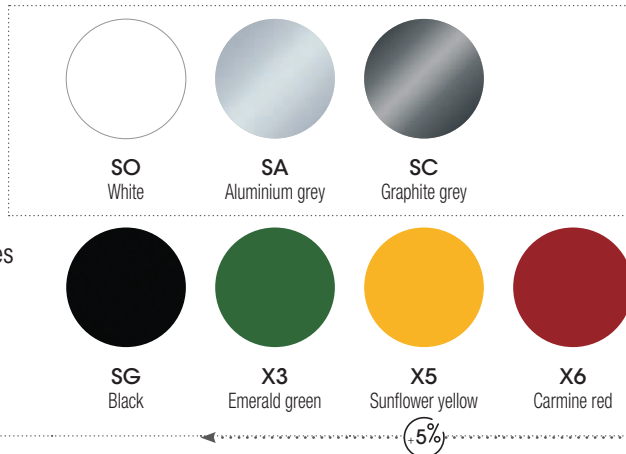

FROM STOCK

ON REQUEST

ON REQUEST: allow 4 weeks for desktop screens and partition screens / 6 weeks for rails and accessories

Desktop screens\*\*

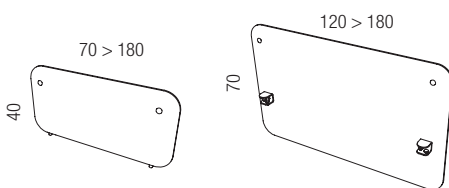

Partition screens\*\*

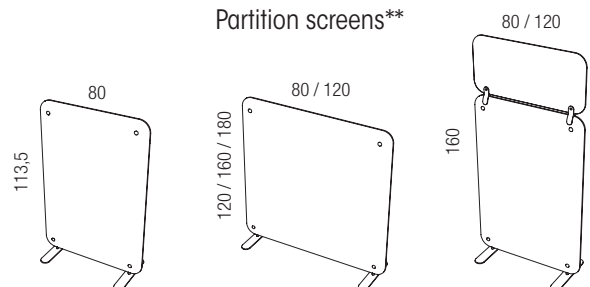

\* Clamps and stabilizer feet supplied together with the ABS screw-on knobs. In White for clamps or stabilizer feet SO/SA and in Graphite grey for clamps and stabilizer feet SC/SG.

\*\* Fixing clamps and stabilizer feet to be ordered separately.

# PRICES

Price excl. taxes: **From stock** **On request**

## FABRIC COVERED ACOUSTIC DESKTOP SCREENS

Bondai fabrics (Cat. A) Xtreme CS fabrics (Cat. B) Blazer fabrics (Cat. D)

Ref. + fab.

### Desktop screens

Outer frame made from aluminium covered with fabric - Core made from honeycomb cardboard 25 mm thick, clad with 1 layer of 10 mm thick acoustic polyester fibre on each panel face - thickness 47 mm. Tackable panel face.

#### Frontal and lateral H.40 cm

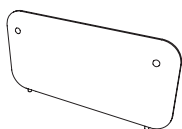

W. 70 cm* (lateral only)	6 459 153	
W. 80 cm*	6 459 130	
W. 100 cm*	6 459 131	
W. 120 cm	6 459 132	
W. 140 cm	6 459 133	
W. 160 cm	6 459 134	
W. 180 cm	6 459 135	

\* Desktop screens W. 70, W. 80 and W. 100 cm may also be positioned laterally on D. 70, D. 80 and D. 100 cm desks. Positioned in a lateral configuration, these desktop screens will only accommodate light-weight accessories.

#### Frontal H. 70 cm - Sit at the front of the worktop, functioning simultaneously as a partition screen and modesty panel.

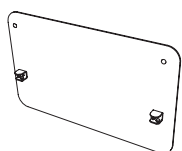

L. 120 cm	6 459 136	
L. 140 cm	6 459 137	
L. 160 cm	6 459 138	
L. 180 cm	6 459 139	

### Fixing clamps



Epoxy coated metal - Clamps supplied together with the ABS screw-on knobs for desktop and partition screens. Compatible with worktops 19 mm to 30 mm thick.

Ref. + fin.

#### Frontal attachment

##### Frontal attachment



Desktop screens H. 40 cm	6 459 140	
Desktop screens H. 70 cm	6 459 143	

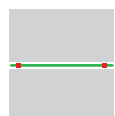

For individual workstations positioned face-to-face or bench desks with shared structural frame and 2 worktops - clamps to both tops		
Desktop screens H. 40 cm	6 459 144	

##### Single worktop desks with shared structural frame - bolt-through attachment

2 options:

- Choose a partition that is 40 cm shorter than the width of the worktop in order to accommodate a lamp or flatscreen monitor arm next to the partition panel.
- Choose a screen of the same width as the desk worktop.

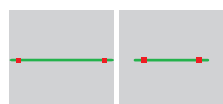

Desktop screens H. 40 cm	6 459 145	
--------------------------	-----------	--

#### Lateral attachment

##### Individual and shared workstations - lateral attachment at desk ends. Fitted to the edge of the worktop using wood screws.



Desktop screens H. 40 cm	6 459 141	
--------------------------	-----------	--

##### Individual and shared workstations - lateral attachment in between desks.



Desktop screens H. 40 cm	6 459 142	
--------------------------	-----------	--

<p>— Desktop screen</p> <p>■ Fixing clamps</p>	<p> <b>Fixing clamps to be ordered separately</b> Must be included in your order</p>
--	--

## HOW TO PLACE AN ORDER ?

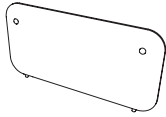

1. Choose  
a **DESKTOP SCREEN**

+



2. Select the necessary **FIXING CLAMPS**  
for a chosen configuration

+

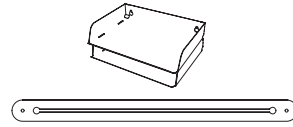

3. Complete your selection by adding an optional  
**RAIL** and corresponding **ACCESSORIES**

### OPTIONS FOR DESKTOP SCREENS

Ref. + fin.

#### Rails

Epoxy coated metal - Attaches to desktop screens thanks to ABS screw-on knobs at the extremities. Applied to desktop screens W. 80/100 cm positioned in a lateral configuration, this rail is only suitable to receive the light weight accessories (i.e. magnetic whiteboard and pen tray). No accessories rail for desktop screens W. 70 cm.

For desktop screens :

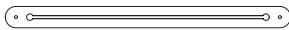

W. 80 cm	6 459 146
W. 100 cm	6 459 147
W. 120 cm	6 459 148
W. 140 cm	6 459 149
W. 160 cm	6 459 150
W. 180 cm	6 459 151

#### Accessories

Ref. + fin.

Epoxy coated metal - Attach to and slide along the rail thanks to track gliders supplied with each accessory. (Colours: 2 White and 2 Graphite grey).

#### Magnetic whiteboard

(magnetic tacks sold separately)

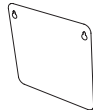

W. 27.5 x H. 27.5 cm x 10/10 mm thick	6 386 120
---------------------------------------	-----------

#### Letter tray - starter/add-on

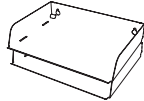

W. 33.5 x H. 6 x D. 25.5 cm	7 626 014
-----------------------------	-----------

#### Planter with 3 compartments

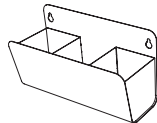

W. 32.7 x H. 18.5 x D. 12.9 cm	7 626 016
--------------------------------	-----------

#### Shelving

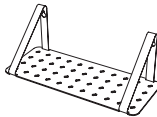

W. 45 x H. 17 x D. 19 cm	7 626 017
--------------------------	-----------

#### Pen tray



W. 22.5 x H. 7.5 x D. 12 cm	6 386 121
-----------------------------	-----------

### FINISHES

Choices of fabrics (+ fab.)

Choices of metal finish for clamps (+ fin.)

Choices of metal colour finish for rail and accessories (+ fin.)

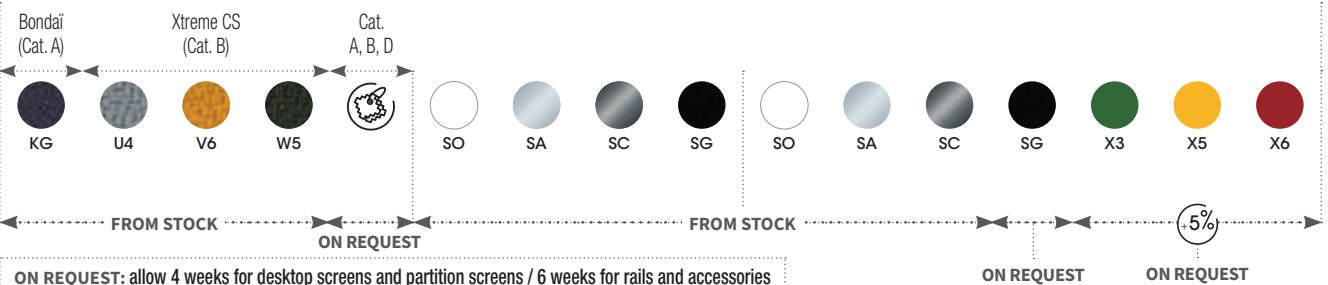



## HOW TO PLACE AN ORDER ?

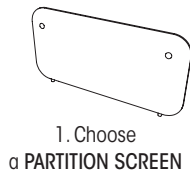

+

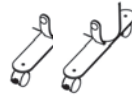

+



### Set of 2 feet

Epoxy coated metal - Stabilizer feet supplied together with the ABS screw-on knobs for partition screens.

#### Individual partition screen configuration



Set of 2 fixed stabilizer feet  
Comprises 2 stabilizer feet

6 387 114

#### Multiple partition screens configuration

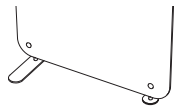

Set of 2 fixed stabilizer feet  
Comprising one circular foot and one stabilizer foot

6 387 113

#### Configuration single screen and in a line



Set of 2 stabilizer feet on castors  
4 black castors ø 65 mm, 2 of which are lockable

6 387 115

### Linking kit

8 flexible connectors with metal clasps - Black finish. Allows the linking of 2, 3 or 4 partitions, either aligned with one another or positioned in multi-directional layouts, thanks to ABS screw-on knobs located on the upper and lower extremities of the partitions. Set of 2 connector kits.



Lot 2 kits de liaison

6 387 116

*It is not possible to link a fabric covered partition with a part-fabric / part-glazed partition. It is not possible to link partition screens of different heights.*

## OPTION FOR PARTITION SCREENS

### Whiteboard

Whiteboard (PMMA) W. 70 x H. 58.5 cm, with epoxy lacquered metal pen tray - Fixing clamps come in a matching finish to the pen tray. Secured to both fabric and part-glazed partition screens W. 80 cm and W. 120 cm using metal clamps. Colours available from stock: White SO, Aluminium grey SA or Graphite grey SC. Other colours available on request.

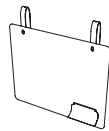

Whiteboard (PMMA) with pen tray

6 386 124



#### Stabilizer feet

To be ordered separately  
Must be included in your order  
Complete with the addition of a connector kit to link multiple partitions screens

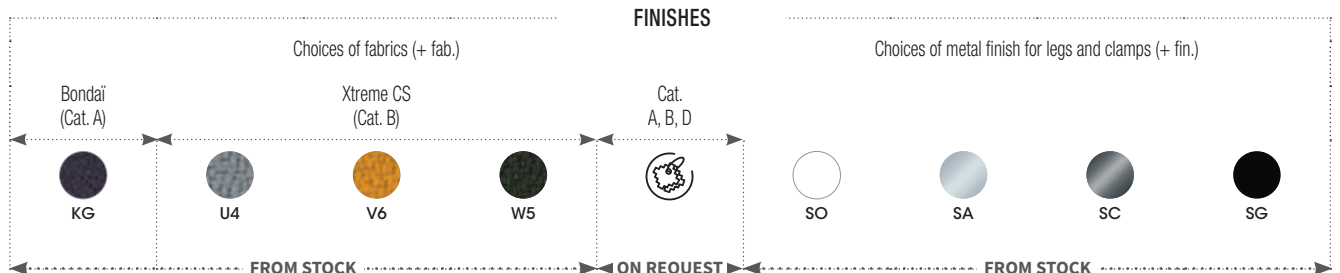

**ON REQUEST: allow 4 weeks for desktop screens and partition screens / 6 weeks for rails and accessories**

# LUCIEN

Thanks to its sturdy design and acoustic properties, LUCIEN is ideal for creating individual spaces that favour privacy and concentration. The partition panels notably feature an aluminium frame that can receive a flatscreen monitor arm and many other accessories to help optimise the workspace. The fabric covered and part-glazed partition screens allow you to define different areas within an open space environment.



- Shared workstations, page 57
- Pedestals, page 121
- Ergonomic chairs, page 195
- Office chairs, page 223
- Desktop lamps, page 253



## Sturdy & functional

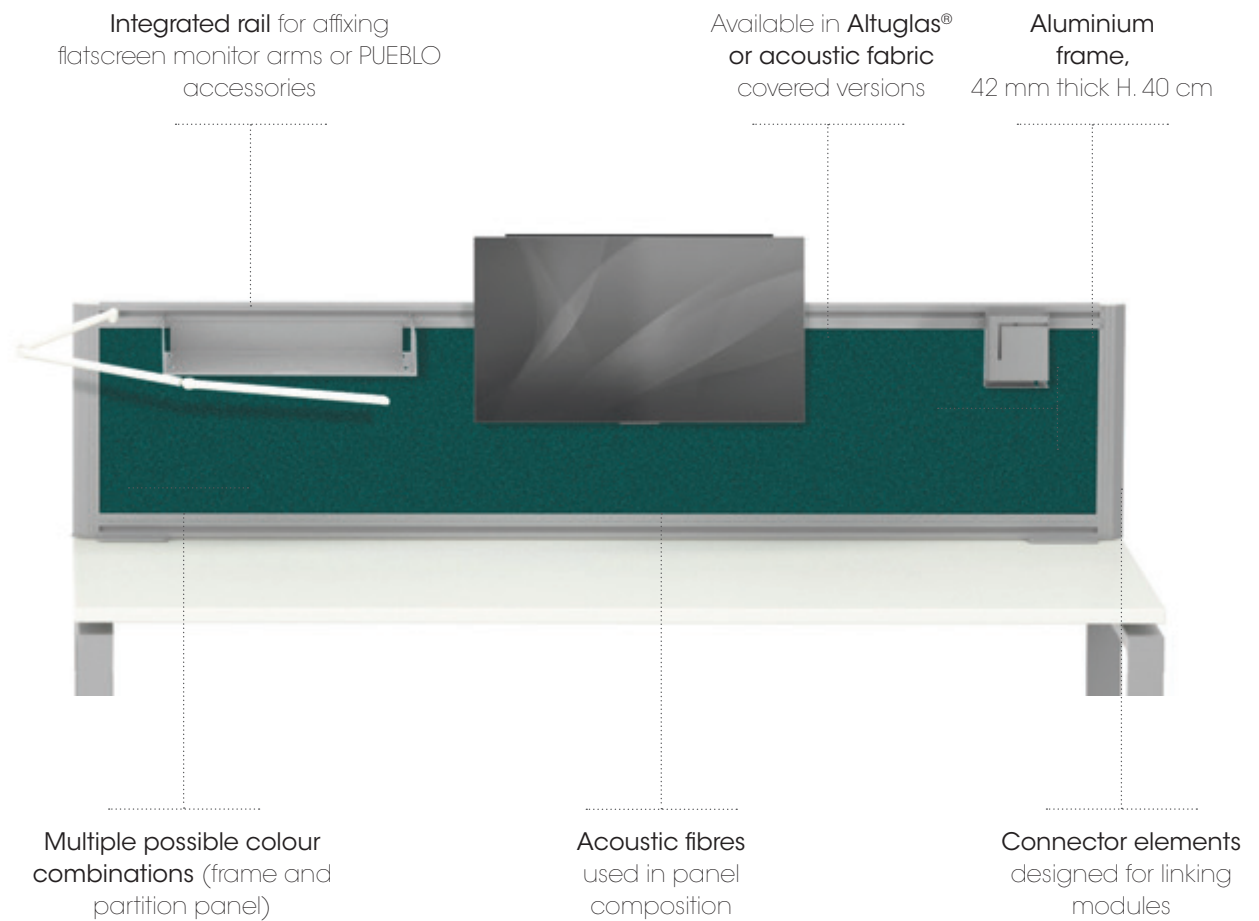



## Structure the workspace

Acoustic fibres used in panel composition

2 panel heights :  
H. 160 and H. 200 cm  
2 panel widths :  
W. 80 and W. 120 cm

Allows the linking of 2, 3 or 4 partitions, either aligned or positioned in multi-directional layouts thanks to connector kits.

Glazed panel made from security glass

Accessories from the PUEBLO range can be affixed to the median profile



Available in full fabric-covered version or 2/3 fabric + 1/3 glazed

Height-adjustable feet

Available in static or mobile versions

Aluminium frame, 42 mm thick

# FINISHES

<p>2 choices of fabric colour (+ fab.)</p>	<p>Bondai (Cat. A) Xtreme CS (Cat. B)</p> <p>FROM STOCK</p>	<p>3 shade cards for fabrics</p> <p>Bondai (Cat. A), Xtreme CS (Cat. B) and Blazer (Cat. D) see page 283</p> <p>ON REQUEST</p>
<p>5 choices of Altuglas® (+ col.)</p>	<p>OA White OB Smoke grey</p> <p>FROM STOCK</p>	<p>O1 Green O4 Yellow OX Red</p> <p>ON REQUEST</p>
<p>3 choices of metal colour finish for frame, clamps, feet and accessories (+ fin.)</p>	<p>SO White SA Aluminium grey</p> <p>FROM STOCK</p>	<p>SC Graphite grey</p> <p>ON REQUEST</p>

ON REQUEST: allow 5 weeks

## HOW TO PLACE AN ORDER ?

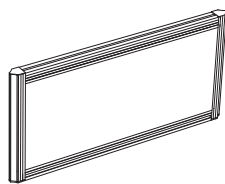

1. Choose a **DESKTOP SCREEN**

+

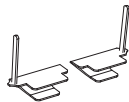

2. Select the necessary **FIXING CLAMPS** for a chosen configuration

+



3. Add a **CONNECTOR KIT** to link multiple partitions screens

+

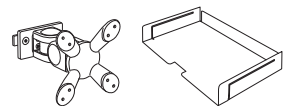

4. Complete your selection by adding optional **FLATSCREEN MONITOR ARMS**, or **accessories from the PUEBLO range**

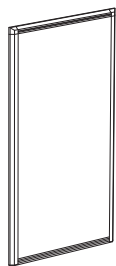

1. Choose a **PARTITION SCREEN**

+

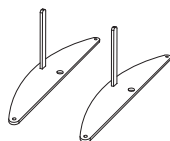

2. Select the necessary stabilizer **FEET** for a chosen configuration

+



3. Add a **CONNECTOR KIT** to link multiple partitions screens

# PRICES

Price excl. taxes: **From stock** **On request**

## ALTUGLAS® AND FABRIC COVERED ACOUSTIC DESKTOP SCREENS

Bondai fabrics (Cat. A) Xtreme CS fabrics (Cat. B) Blazer fabrics (Cat. D)

Ref. + fab. + fin.

Accessories can be affixed to the upper profile of frontal partition screens: rail-mounted flatscreen monitor arms (see page 258) and accessories from the PUEBLO range (see page 119).

### Fabric covered rectangular frontal desktop screens

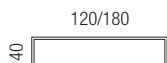

W. 120 cm	6 494 096	
W. 140 cm	6 494 097	
W. 160 cm	6 494 098	
W. 180 cm	6 494 099	

### Altuglas® rectangular frontal desktop screens



W. 120 cm	6 459 126	
W. 140 cm	6 459 127	
W. 160 cm	6 459 128	
W. 180 cm	6 459 129	

### Lateral rectangular fabric desktop screens or curved Altuglas® screens

For configurations incorporating fixed height workstations on shared structural frames (CONNECT range). Positioned laterally, the partition screen fits in between 2 worktops as a prolongation of a frontal desktop screen. Positioned laterally at desk extremities, the desktop screen attaches to the edge of the worktop.



Lateral rectangular fabric desktop screen (set of 2)

Ref. + fab. + fin.	
6 494 100	



Curved Altuglas® lateral desktop screen (set of 2)

Ref. + col. + fin.	
6 459 114	

### Fixing clamps



Metal fixing clamps. Compatible with worktops from 25 mm to 30 mm thick.



Standard clamps for individual workstations (set of 2)

Frontal attachment	6 494 093	
--------------------	-----------	--

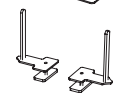

Twin clamps for individual workstations positioned face-to-face (set of 2)

Frontal attachment	6 494 094	
--------------------	-----------	--

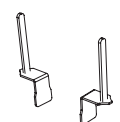

Twin bridge clamps for shared structural frame workstations (set of 2). Compatible with shared structural frame workstations comprising 2 individual desks (CONNECT range)

Shared structural frame D. 165 cm	6 494 092	
Shared structural frame D. 142 cm	6 494 095	

### Connector kits for desktop screens



Must be ordered separately in order to link multiple partition screens. Grey ABS connectors for frontal and lateral desktop screens, 1 connector kit allows the linking of 2, 3 or 4 frontal and lateral screens.

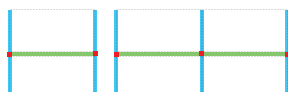

1 connector kit H. 40 cm	6 459 118	
--------------------------	-----------	--

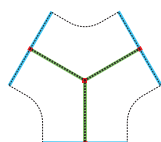

- Work surface
- Desktop screen for desk W. 120 to 180 cm
- Lateral screen W. 81.7 cm
- Connector kit

**Fixing clamps**  
To be ordered separately. Fixing clamps must be included in your order. Complete with the addition of a connector kit to link multiple partition screens.

FABRIC

COVERED ACOUSTIC PARTITION SCREENS

Bondai fabrics (Cat. A) Xtreme CS fabrics (Cat. B) Blazer fabrics (Cat. D)

Ref. + fab. + fin.

**Fabric covered acoustic partition screens**

Stabilizer feet must be ordered separately in accordance with the chosen configuration: see recommendations opposite.  
PUEBLO range accessories can be affixed to the median profile of mixed fabric/glazed partitions (see page 119).

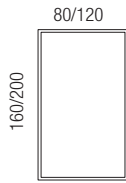

**Fabric covered partition screen**

H. 160 x W. 80 cm	6 493 301
H. 160 x W. 120 cm	6 493 300
H. 200 x W. 80 cm	6 493 303
H. 200 x W. 120 cm	6 493 302

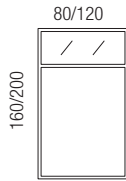

**Partitions 2/3 fabric 1/3 glazed**

H. 160 x W. 80 cm	6 493 305
H. 160 x W. 120 cm	6 493 304
H. 200 x W. 80 cm	6 493 307
H. 200 x W. 120 cm	6 493 306

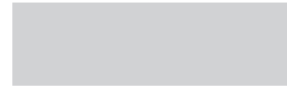

OPTIONS FOR ACOUSTIC PARTITION SCREENS

Ref. + fin.

**Stabilizer feet**

Affix to the base of acoustic partition screens.



Positioned in line, 2 feet are required for each starter partition, followed by 1 additional foot every 2 partition screens. If 2 partitions forming an angle, 'T' shaped configuration (3 partitions) or cruciform (4 partitions), stabilizer feet are not required.

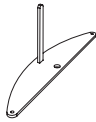

Stabilizer feet

6 493 194

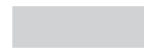

**Set of 4 self-braking castors**

Mounted to the underside of stabilizer feet. Ø 65 mm. For 2 stabilizer feet.

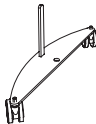

Set of 4 castors

6 493 195

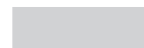

**Cable trough**

Secures to the lower section of the partition screen, allows the concealed channelling of cables.

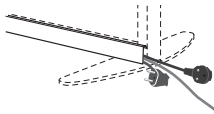

For partitions W. 80 cm

6 493 212

For partitions W. 120 cm

6 493 213

**Connector kit**



Use to link multiple partition screens together. Allows the creation of variable angle layouts.

Allow for one connector kit to link 2, 3 or 4 partitions. For linear configurations, foresee one connector kit per additional partition screen.



For partitions W. 160 cm

6 493 310

For partitions W. 200 cm

6 493 311

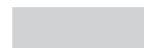

**FINISHES**

Choice of fabrics (+ fab.)

Choice of Altuglas® colour (+ col.)

Choice of metal colour finish for frame, clamps, feet and accessories (+ fin.)

Bondai (Cat. A)	Xtreme CS (Cat. B)	Cat. A, B, D	OA	OB	O1	O4	OX	SO	SA	SC
KG	U4									
FROM STOCK		ON REQUEST	FROM STOCK			ON REQUEST	FROM STOCK		ON REQUEST	

**Stabilizer foot and connector kit**  
To be ordered separately  
Order in accordance with the chosen configuration

ON REQUEST: allow 5 weeks

# ACCESSORY RAILS

+ Optimise and free up your work space

PUEBLO accessories for  
attaching to the accessory rail



Possibility to affix flatscreen  
monitor arms

Metal structure  
Overall height: 30 cm  
Rail height: 10 cm

Compatible with worktops 25 mm  
to 34 mm thick



# PRICES

Price excl. taxes: **From stock** **On request**

## ACCESSORY RAILS

Ref. + fin.

Set of 2 uprights fitted with desk clamps, for individual desks or face-to-face workstation configurations. Rails for twin workstations are designed to carry PUEBLO accessories (see below), rail-mounted flatscreen monitor arms (see p. 258) and the OL03 rail-mounted lamp (see p. 262).



### Individual desks

W. 120 cm 7 466 018

W. 160 cm 7 466 019

### Twin workstations

W. 120 cm 7 466 020

W. 160 cm 7 466 021

## PUEBLO ACCESSORIES

Ref. + fin.

Made from lacquered epoxy steel. Can be fitted to accessory rails, to TWINS desktop screen rails and to the upper profile of LUCIEN desktop screens. May also be placed directly on the work surface (except 3 slot diagonal sorting tray).

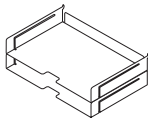

### Letter tray - starter unit

W. 33.5 x D. 22 x H. 5 cm 7 521 001



### Letter tray add-on unit

W. 33.5 x D. 22 x H. 5.2 cm 7 521 002

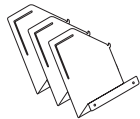

### Pencil cup

W. 8.4 x D. 3.8 x H. 10 cm 7 521 003

### 3-compartment sorting unit

W. 38.5 x D. 22 x H. 23.5 cm 7 521 004

## FINISHES

3 choices of metal finish (+ fin.)



**SO**  
White



**SA**  
Aluminium  
grey



**SC**  
Graphite  
grey

FROM STOCK

ON REQUEST

ON REQUEST: allow 6 weeks