

Executive Furniture

215



Mundi	216
Actium	230
Inveo	242
Kara	256
M38	268
Rio	280

Mundi

Mundi stands out as a novel concept defined by a compelling visual identity. Thanks to a large choice of distinctive worktops, leg profiles and finishes, this highly customisable furniture range engages the end user in the design of a singular and inspiring office space.



"One can't help but be completely seduced by Mundi's refined use of wood veneers and the appeal of its presence in the workspace."

CLAUDE ARMAND Director of Industrial Operations



The importance of leading by example



Discreet cable management solutions afforded by the sleek steel panel leg design





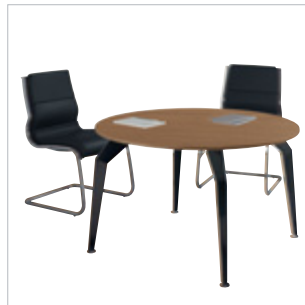
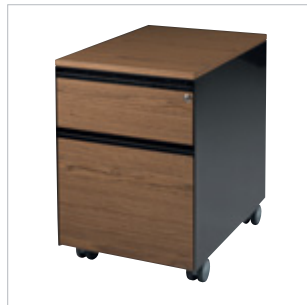
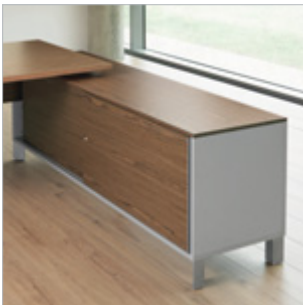

MUNDI, where **aesthetic styling** and **functional elegance** converge to meet user needs



Customise your worktop to suit your image with desk mats available in various materials. Choose between the **warmth** afforded by wood, the **modern touch** of glass or the **inspirational grandeur** of leather.

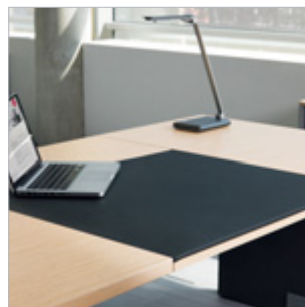
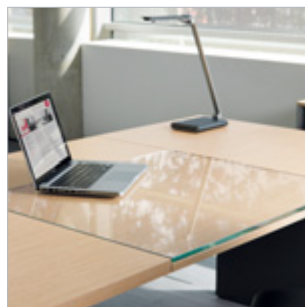



Shade card

3 choices of wood veneer worktops from stock and 1 on request



JQ
Light oak



JS
Walnut



JR
Ebony



JU*
Olive tree

*on request (allow 6 weeks for delivery)

4 choices of glass worktops from stock



GB
Enamelled
glossy light grey



GD
Enamelled
glossy black



GA**
Transparent
frosted

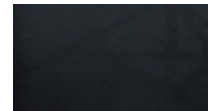

GH**
Transparent
smoked grey

**metal panel leg design only

1 finish for metal panel legs



SU
Mouse grey

2 choices of finish for the metal decorative trim for wood veneer panel legs



SA
Aluminium



LW
Glossy black
grey

Being a natural product, wood veneers may appear to vary in colouring and pattern, particularly when viewed at different angles to the grain and at different angles to the light.

The Range

Rectangular desks and extension units

Wood veneer tops

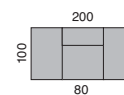
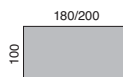

Glass tops

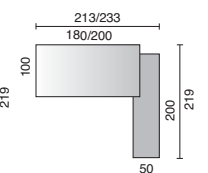
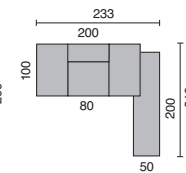
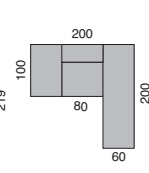
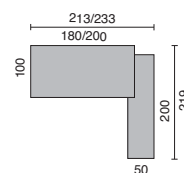
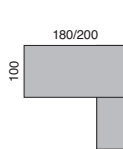

Meeting tables

Wood veneer tops

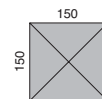

Glass tops

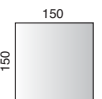

Standards



Technical specifications

Particle board panels with density 670 to 690 kg/m³ overlaid with a sheet of decorative wood veneer, 7/10 thick natural aspect veneer coated with semi-matt water based varnish.

Tops 17.4 mm thick – Desk height: 72.74 cm.

Tops 31.4 mm thick – Desk height: 74.14 cm.

Tops 12 mm thick – Desk height: 72.2 cm.

1 Wood veneer tops 17.4 mm in thickness. Desk top with wood veneer edging, rounded at the top and bottom and matching the worktop decorative finish.

2 Wood veneer tops 31.4 mm thick, with customisable central section. Desk top with straight wood veneer edging, rounded at the top and bottom, matching the worktop decorative finish

- Wood veneer top

- Wood veneer top with integrated leather insert (desk mat)

- Wood veneer top with integrated clear glass insert (desk mat)

3 Toughened safety glass top 12 mm thick. Smoothed joins and rounded edges for maximum user comfort. 3 choices of finish : clear glass with enamelled underside, frosted clear glass, tinted glass.

4 Wood veneer panel legs 61.4 mm thick, with wood veneer edging with rounded edges. A triangular section metal element (1.5 mm thick) adorns the lower portion of the panel leg. The desk leg panels are raised off the floor by means of levelling glides fitted with 2 stabilizer feet \varnothing 25 mm, adjustable in height through 15 mm. Levelling glide depth: 100 or 60 cm.

5 Metal panel leg 9.3 cm thick. A removable metal cover on the external façade of the leg allows access to the cable management housing concealed within the leg structure. Legs rest on 4 hexagonal stabilizer feet \varnothing 50 mm, adjustable through 15 mm. Panel leg depth: 75.6 or 50.6 cm. Metal crossbars in an aluminium grey finish.

6 The wood veneer panel leg structure is composed of 2 triangular section 2 mm thick crossbars and a structural modesty panel, all presented in a wood veneer finish. The whole is held together by means of cam fittings and screws with metal inserts. In the glazed desk version, the glass top rests on suction pads.

7 Optional metal modesty panel 0.7 mm thick, matching the finish of the metal panel leg. Attaches to the metal crossbars on the underside of the worktop. Dim.: H. 30 x W.110 cm.

8 9 Supporting return composed of a melamine shell and a choice of melamine or wood veneer structural top. The unit is divided into 3 compartments separated by 2 internal partitions. Two of the compartments include an adjustable shelf. The metal sliding doors are assorted to the legs, metal panels or wood veneer doors. The height-adjustable doors rest on a runner allowing the panel to slide smoothly along a profiled aluminium rail. Each sliding door is fitted with an end-of-run damping mechanism. The unit sits on 5 triangular section metal legs, fitted with stabilizer feet.

10 Cupboard drop leaf door and shell made from 19 mm thick melamine. Doors and decorative top made from 17.4 mm wood veneer matching the tops. Melamine shelves and ABS edging in a matching finish. Wood veneer doors open by means of "Push&Pull" system (no handles). Central compartment fitted with drop leaf door, handle fitted flush along the length of the door top (profiled aluminium channel). Wood grain aligned horizontally along the width of the door. Adjustable stabilizer feet.



Metal panel legs

■ Rectangular desks



Glass tops

W. 180 x D. 100 cm
W. 200 x D. 100 cm

Enamelled

3 150 016 + top + SU
3 150 017 + top + SU

Transparent

3 150 016 + top + SU
3 150 017 + top + SU



Wood veneer tops 17.4 mm thick

W. 180 x D. 100 cm
W. 200 x D. 100 cm

From stock

3 150 014 + top + SU
3 150 015 + top + SU

On request

3 150 014 JU SU
3 150 015 JU SU



Wood veneer tops 31.4 mm thick - integrated desk mat

W. 200 x D. 100 cm - wooden insert
W. 200 x D. 100 cm - leather insert
W. 200 x D. 100 cm - glass insert

3 150 018 + top + SU
3 150 019 + top + SU
3 150 020 + top + SU

3 150 018 JU SU
3 150 019 JU SU
3 150 020 JU SU

■ Rectangular desks with supporting return

Melamine return shell in a high gloss black RO or aluminium grey MH finish (+ col). Metal handles in assorted finish. Return unit depth: 50 cm

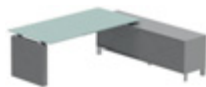

Glass tops

Structural melamine top matching the return unit shell. Sliding doors in a mouse grey finish.
W. 213 x P. 219 cm
W. 233 x P. 219 cm

Enamelled

3 150 025 + top + col. + SU
3 150 026 + top + col. + SU

Transparent

3 150 025 + top + col. + SU
3 150 026 + top + col. + SU



Wood veneer tops 17.4 mm thick

Structural wood veneer top and sliding doors assorted to worktop finish
W. 213 x D. 219 cm
W. 233 x D. 219 cm

From stock

3 150 021 + top + col. + SU
3 150 022 + top + col. + SU

On request

3 150 021 + JU + col. + SU
3 150 022 + JU + col. + SU



Structural melamine top matching the return unit shell. Sliding doors in matching finish to the worktops.

W. 213 x D. 219 cm
W. 233 x D. 219 cm

3 150 023 + top + col. + SU
3 150 024 + top + col. + SU

3 150 023 + JU + col. + SU
3 150 024 + JU + col. + SU



Wood veneer tops 31.4 mm thick - integrated desk mat

Structural wood veneer top and sliding doors assorted to worktop finish
W. 233 x D. 219 cm - wooden insert
W. 233 x D. 219 cm - leather insert
W. 233 x D. 219 cm - glass insert

3 150 027 + top + col. + SU
3 150 028 + top + col. + SU
3 150 029 + top + col. + SU

3 150 027 + JU + col. + SU
3 150 028 + JU + col. + SU
3 150 029 + JU + col. + SU

■ Desks with three leaf worktops and fixed return

Fixed return depth. 60 cm

Wood veneer tops 31.4 mm thick integrated desk mat

W. 200 x D. 200 cm - wooden insert
W. 200 x D. 200 cm - leather insert
W. 200 x D. 200 cm - glass insert

From stock

3 150 030 + top + SU
3 150 031 + top + SU
3 150 032 + top + SU

On request

3 150 030 JU SU
3 150 031 JU SU
3 150 032 JU SU

4 choices of decorative finish for tops (+ top) and wood veneer legs (+ col. 1)

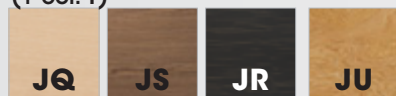

From stock

On request

4 choices of glass top finish (+ top)



From stock

* metal panel legs only

1 metal panel leg finish

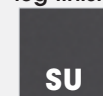

From stock

2 choices of finish for metal elements on wood veneer legs (+ leg)



From stock

2 choices of finish for supporting return shells (+ col.)



From stock

■ Rectangular desks with fixed return



Wood veneer tops 17.4 mm thick From stock

W. 180 x D. 200 cm

3 150 033 + top + SU

W. 200 x D. 200 cm

3 150 034 + top + SU

On request

3 150 033 JU SU

3 150 034 JU SU



■ Optional metal modesty panel

For wood veneer or glass top desks. Attaches to the crossbars

For desks W. 180 et W. 200 cm

3 140 026 SU

Wood veneer panel legs

■ Rectangular desks

Wood veneer panel leg (+ col. 1)



Enamelled glass tops

W. 180 x D. 100 cm

From stock

3 150 037 + top + col. 1 + leg

On request

3 150 037 + top + JU + leg

W. 200 x D. 100 cm

3 150 038 + top + col. 1 + leg

3 150 038 + top + JU + leg



Wood veneer tops 17.4 mm thick

W. 180 x D. 100 cm

3 150 035 + top + leg

3 150 035 JU + leg

W. 200 x D. 100 cm

3 150 036 + top + leg

3 150 036 JU + leg



Wood veneer tops 31.4 mm thick - integrated desk mat

W. 200 x D. 100 cm - wooden insert

3 150 039 + top + leg

3 150 039 JU + leg

W. 200 x D. 100 cm - leather insert

3 150 040 + top + leg

3 150 040 JU + leg

W. 200 x D. 100 cm - glass insert

3 150 041 + top + leg

3 150 041 JU + leg

■ Rectangular desks with supporting return

Melamine desk return shell in a high gloss black or aluminium grey finish, in matching finish to the metal elements of the frame and legs. Metal handles in an assorted finish. Return unit depth : 50 cm



Enamelled glass tops

Structural melamine top in matching finish to the metal element of the leg (+ leg). Wood veneer sliding doors matching the panel leg decorative finish (+ col. 1)

W. 213 x D. 219 cm

3 150 048 + top + col. 1 + leg

3 150 048 + top + JU + leg

W. 233 x D. 219 cm

3 150 049 + top + col. 1 + leg

3 150 049 + top + JU + leg



Structural wood veneer top and sliding doors assorted to panel leg decorative finish.

W. 213 x D. 219 cm

3 150 046 + top + col. 1 + leg

3 150 046 + top + JU + leg

W. 233 x D. 219 cm

3 150 047 + top + col. 1 + leg

3 150 047 + top + JU + leg

Wood veneer tops 17.4 mm thick

Structural melamine top in matching finish to the metal element of the leg. Wood veneer sliding doors matching the worktop finish.

W. 213 x D. 219 cm

3 150 044 + top + leg

3 150 044 JU + leg

W. 233 x D. 219 cm

3 150 045 + top + leg

3 150 045 JU + leg

Structural wood veneer top and sliding doors assorted to worktop and panel leg decorative finish

W. 213 x D. 219 cm

3 150 042 + top + leg

3 150 042 JU + leg

W. 233 x D. 219 cm

3 150 043 + top + leg

3 150 043 JU + leg

Wood veneer tops 31.4 mm thick - integrated desk mat

Structural wood veneer top and sliding doors assorted to worktop and panel leg decorative finish

W. 233 x D. 219 cm - wooden insert

3 150 050 + top + leg

3 150 050 JU + leg

W. 233 x D. 219 cm - leather insert

3 150 051 + top + leg

3 150 051 JU + leg

W. 233 x D. 219 cm - glass insert

3 150 052 + top + leg

3 150 052 JU + leg



■ Desks with wood veneer tops and integrated desk mat, fixed return

Fixed return depth : 60 cm



Wood veneer tops 31.4 mm thick - integrated desk mat	From stock		On request	
W. 200 x D. 200 cm - wooden insert	3 150 053 + top + leg		3 150 053 JU + leg	
W. 200 x D. 200 cm - leather insert	3 150 054 + top + leg		3 150 054 JU + leg	
W. 200 x D. 200 cm - glass insert	3 150 055 + top + leg		3 150 055 JU + leg	

■ Rectangular desks with fixed return

Fixed return W. 100 x 60 cm



Wood veneer tops 17.4 mm thick	From stock		On request	
W. 180 x D. 200 x 60 cm	3 150 056 + top + leg		3 150 056 JU + leg	
W. 200 x D. 200 x 60 cm	3 150 057 + top + leg		3 150 057 JU + leg	

Meeting tables

Metal legs in an aluminium grey SA or high gloss black LW finish

■ Circular tables

On central stem with circular base



Glass tops	Enamelled		Transparent	
ø 120 cm	3 150 060 + top + leg		3 150 060 + top + leg	
Wood veneer tops 17.4 mm thick	From stock		On request	
ø 120 cm	3 150 058 + top + leg		3 150 058 JU + leg	

■ Square tables

On centred Frame base



Glass tops	Enamelled		On request	
W.150 x D. 150 cm	3 150 061 + top + leg		3 150 059 JU + leg	
Wood veneer tops 17.4 mm thick	From stock			
W. 150 x D. 150 cm	3 150 059 + top + leg			

Easy reach storage units

■ Metal mobile pedestals

Pedestal drawer fronts with wood veneer inlay W. 42 x D. 56 x H. 58.8 cm



	From stock		On request	
1 box drawer + 1 filing drawer	3 150 062 + top + leg		3 150 062 JU + leg	
3 box drawers	3 150 063 + top + leg		3 150 063 JU + leg	
Optional wood veneer top for pedestals				
	3 150 064 + top		3 150 064 JU	

■ Low credenzas with sliding doors

Wood veneer sliding doors

Structural wood veneer top and sliding doors (+ top). Melamine shell in a high gloss black RO or aluminium grey MH finish (+col.). Metal handles in assorted finish. Resting on 5 triangular metal feet in matching finish to the credenza shell.



	From stock		On request	
H. 66.6 x W. 200 x D. 50 cm	3 150 065 + top + col.		3 150 065 JU + col.	

Metal sliding doors

Sliding doors in a mouse grey finish. Structural melamine top and shell in a high gloss black RO or aluminium grey MH finish (+col.). Metal handles in assorted finish. Resting on 5 triangular metal feet in matching finish to the credenza shell.



H. 66.6 x W. 200 x D. 50 cm	3 150 066 SU + col.	
-----------------------------	---------------------	--

4 choices of decorative finish for tops (+ top) and wood veneer legs (+ col. 1)

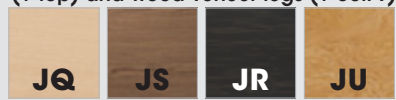

From stock On request

4 choices of finish for glass tops and doors (+ top)



From stock * Only for metal panel legs

1 metal panel leg finish



From stock

2 choices of finish for metal elements on wood veneer legs (+ leg)

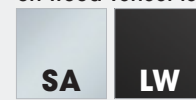

From stock

Deco storage solutions

Melamine cupboard shell in a high gloss black RO or aluminium grey MH finish (+col.). Wood veneer doors (+ top). Drop leaf compartment door assorted to the melamine structure finish

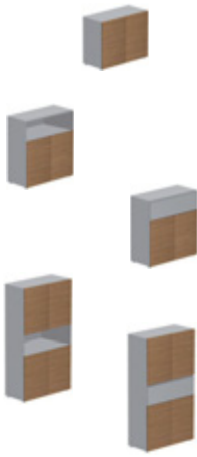

	From stock	On request
Low cupboard H. 83.5 x W. 100 x D. 46 cm - 1 shelf 2 wood veneer doors	3 150 067 + top + col.	3 150 067 JU + col.
Medium cupboard H. 115.7 x W. 100 x D. 46 cm - 2 shelves 2 wood veneer doors, with open compartment in top section	3 150 068 + top + col.	3 150 068 JU + col.
2 wood veneer doors, with drop leaf compartment door in top section	3 150 069 + top + col.	3 150 069 JU + col.
High cupboard H. 191.7 x W. 100 x D. 46 cm - 4 shelves 4 wood veneer doors, with open compartment in central section	3 150 070 + top + col.	3 150 070 JU + col.
4 wood veneer doors, with drop leaf compartment door in central section	3 150 071 + top + col.	3 150 071 JU + col.

Optional extras for Deco cupboards

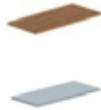

	From stock	On request
Optional wood veneer top For Deco cupboards W. 100 cm	3 140 009 + top	3 140 009 JU
Additional melamine shelf For Deco cupboards	3 140 043 + col.	

Traditional storage solutions

Melamine cupboard shell and shelves 19 mm thick. 2 choices of finish : MH aluminium grey or MY graphite grey (+ fin.). Handles in an aluminium grey finish. Toughened safety glass doors 4 mm thick with aluminium frame

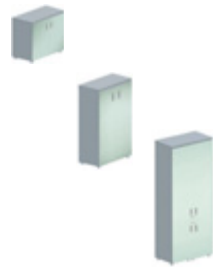

	Enamelled	Transparent
Low cupboard H. 71 x W. 80 x D. 42.6 cm - 1 shelf 2 glass doors	3 150 072 + top + fin.	3 150 072 + top + fin.
Medium cupboard H. 133.3 x W. 80 x D. 42.6 cm - 3 shelves 2 glass doors	3 150 073 + top + fin.	3 150 073 + top + fin.
High cupboard H. 197.3 x W. 80 x D. 42.6 cm - 4 shelves 4 glass doors	3 150 074 + top + fin.	3 150 074 + top + fin.

Optional extras for traditional storage units

Optional melamine shelf in an aluminium grey or graphite grey finish For cupboards W. 80 cm	3 150 075 + fin.
---	------------------

Optional decorative top for traditional storage units - contact us for details

2 choices of finish for supporting return shells (+ col.)



From stock

2 choices of finish for traditional cupboard shells (+ fin.)



From stock

Safes p. 168.



Executive chairs p. 290.

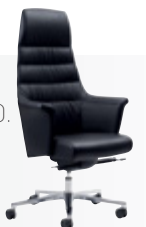

Actium

Actium, a modern rendition of the office space. Crisp leg profiles and convivial worktop designs offer an appealing meeting space for visitors. Rich wood veneers and modern glazed surfaces convene in this singular collection of executive office furniture.



"Combining solid construction with gracefully drawn silhouettes, Actium is at the cutting edge of executive office design."

FRANCIS LEGROUT Technical Director, Product Design and Processes



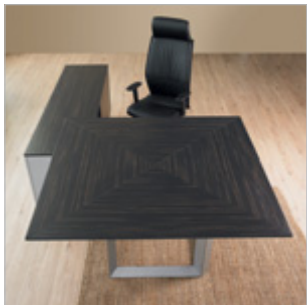

Striking quadrangular desks invite both a sense of purpose and conviviality









Shade card

3 choices of wood veneer tops from stock and 1 on request

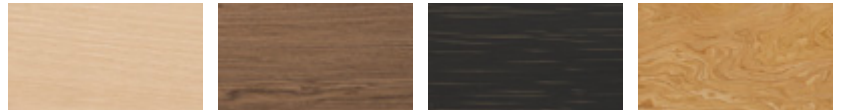

JQ Light oak **JS** Walnut **JR** Ebony **JU*** Olive tree

*on request (allow 6 weeks for delivery)

4 choices of glass tops from stock



GB Enamelled glossy light grey **GD** Enamelled glossy black **GA**** Transparent frosted **GH**** Transparent smoked grey

** 4 leg models only

2 choices of finish for metal legs



SA Aluminium grey **LW** Glossy black

Being a natural product, wood veneers may appear to vary in colouring and pattern, particularly when viewed at different angles to the grain and at different angles to the light.

The Range

Desking and extension units

Wood veneer tops

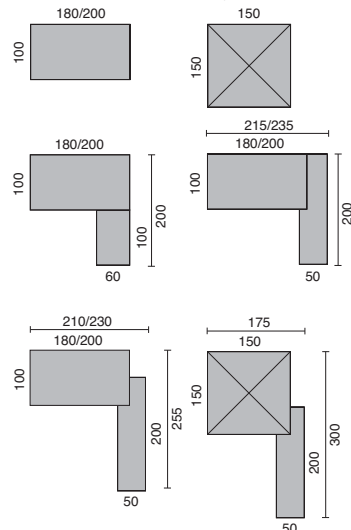

Glass tops

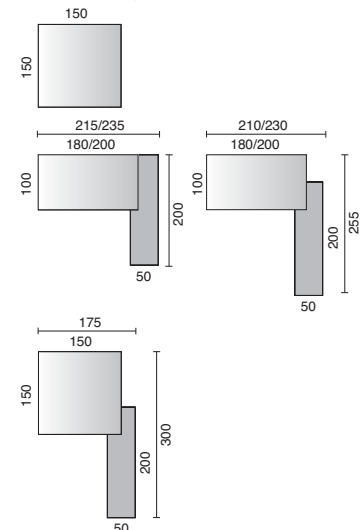

Meeting tables

Wood veneer tops

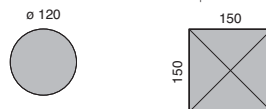

Glass tops

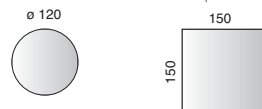

Standards



Technical specifications



1



2



3

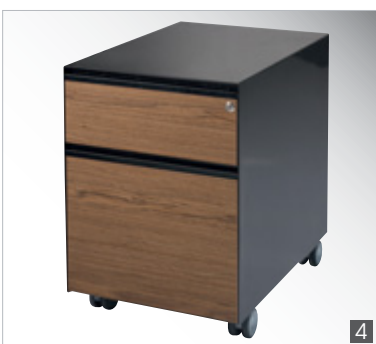

4

Tops 17.4 mm thick - Desk height: 72.74 cm.

Tops 12 mm thick - Desk height : 72.2 cm.

Fibre board panels, with density 670 to 690 kg/m³ (standard density for wood veneer purposes) covered in a decorative wood veneer overlay. Natural aspect 7/10 thick veneer coated with semi-matt water based varnish.

1 Wood veneer tops 17.4 mm thick. Desk top has straight sides covered in wood veneer edging, rounded at the top and bottom, matching the worktop decorative finish.

2 Wood veneer tops 17.4 mm thick, 150 x 150 cm. Formed by joining of 4 triangular sections assembled with steel brackets to the metal frame of the desk. The wood grain is aligned to converge at the geometric centre of the top.

3 Toughened safety glass top 12 mm thick. Smoothed joins and rounded edges for maximum user comfort. 3 choices of finish: clear glass with enamelled underside, frosted clear glass, tinted glass.

4 Mobile metal pedestal with inlayed wood veneer front panels. Fitted with recessed metal handles matching pedestal shell. Optional wood veneer top. Metal drawers mounted on ball-bearing runners. All drawers open to a depth of 100%. Integrated pen tray. Central locking mechanism.

5 Metal desk structure comprising a supporting frame made from triangular section tubular steel. 4 legs made from 15/10 sheet steel. Top plates secured to the desk frame with metal screws on the outside of the leg. Legs fitted with stabilizer feet ø 50 mm, adjustable through 15 mm.

6 Triangular section tubular steel "Frame" design legs (59 x 59 x 80 mm). Structural rigidity ensured by a tubular horizontal crossbar assembled to the lower leg sections. Fitted with stabilizer feet, adjustable through 15 mm.

7 Optional grooved metal modesty panel H. 27 cm, suitable for rectangular desks with melamine or glass tops.

8 Cupboard with high gloss melamine shell 19 mm thick. Doors and decorative top made from 17.4 mm thick wood veneer, matching the desk worktops. High gloss melamine shelves 28 mm thick, matching the cupboard shell. Melamine edging in the same finish as the cupboard shell and shelving. Wood veneer doors open by means of "Push&Pull" system (no handles). Central compartment with drop leaf door, handle fitted flush along the length of the door top (profiled aluminium channel). Wood grain aligned horizontally along door width.



5



6



7



8

4 legs - supporting steel frame

■ Square desks



Glass tops

W. 150 x D. 150 cm

Enamelled

3 160 023 + top + leg

Transparent

3 160 023 + top + leg

Wood veneer tops

W. 150 x W. 150 cm

From stock

3 160 020 + top + leg

On request

3 160 020 JU + leg

■ Rectangular desks



Glass tops

W. 180 x D. 100 cm

W. 200 x D. 100 cm

Enamelled

3 160 021 + top + leg

3 160 022 + top + leg

Transparent

3 160 021 + top + leg

3 160 022 + top + leg



Wood veneer tops

W. 180 x D. 100 cm

W. 200 x D. 100 cm

From stock

3 160 018 + top + leg

3 160 019 + top + leg

On request

3 160 018 JU + leg

3 160 019 JU + leg

■ Square desks with fixed supporting return

Melamine return shell in a high gloss black RO or aluminium grey MH finish, matching the metal leg finish. Metal handles in assorted finish.



Glass tops

W. 175 x D. 300 cm

W. 175 x D. 300 cm

From stock

Structural melamine top matching the metal leg finish. Wood veneer sliding doors (+ col.)

3 160 035 + top + leg + col.

Structural wood veneer top and sliding doors (+ col.)

3 160 032 + top + leg + col.

On request

3 160 035 + top + leg + JU

3 160 032 + top + leg + JU



Wood veneer tops

W. 175 x D. 300 cm

W. 175 x D. 300 cm

From stock

Structural melamine top matching the supporting return and metal leg finish. Sliding doors assorted to worktop finish.

3 160 029 + top + leg

Structural wood veneer top and sliding doors assorted to worktop finish.

3 160 026 + top + leg

On request

3 160 029 JU + leg

3 160 026 JU + leg

■ Rectangular desks with supporting return

Melamine return shell in a high gloss black RO or aluminium grey MH finish, matching the metal leg finish. Metal handles in assorted finish.



Glass tops

W. 210 x D. 255 cm

W. 230 x D. 255 cm

From stock

Structural melamine top matching the metal leg finish. Wood veneer sliding doors (+ col.)

3 160 033 + top + leg + col.

Structural wood veneer top and sliding doors (+ col.)

3 160 034 + top + leg + col.

On request

3 160 033 + top + leg + JU

3 160 034 + top + leg + JU

W. 210 x D. 255 cm

W. 230 x D. 255 cm

3 160 030 + top + leg + col.

3 160 031 + top + leg + col.

3 160 030 + top + leg + JU

3 160 031 + top + leg + JU



Wood veneer tops

W. 210 x D. 255 cm

W. 230 x D. 255 cm

From stock

Structural melamine top matching the supporting return and metal leg finish. Sliding doors assorted to worktop finish.

3 160 027 + top + leg

Structural wood veneer top and sliding doors assorted to worktop finish.

3 160 028 + top + leg

On request

3 160 027 JU + leg

3 160 028 JU + leg

W. 210 x D. 255 cm

W. 230 x D. 255 cm

3 160 024 + top + leg

3 160 025 + top + leg

3 160 024 JU + leg

3 160 025 JU + leg

■ Optional vertical cable holder

Metal cable holder for 4-leg desks, attaches magnetically to metal legs

3 160 069 + leg

Frame legs

■ Square desks



Glass tops
W. 150 x D. 150 cm

Enamelled
3 160 041 + top + leg



Wood veneer tops
W. 150 x W. 150 cm

From stock
3 160 038 + top + leg



On request
3 160 038 JU + leg



■ Rectangular desks



Glass tops
W. 180 x D. 100 cm
W. 200 x D. 100 cm

Enamelled
3 160 039 + top + leg
3 160 040 + top + leg



Wood veneer tops
W. 180 x D. 100 cm
W. 200 x D. 100 cm

From stock
3 160 036 + top + leg
3 160 037 + top + leg



On request
3 160 036 JU + leg
3 160 037 JU + leg



■ Square desks with supporting return

Melamine desk return shell in a high gloss black RO or aluminium grey MH finish, matching the metal leg finish. Metal handles in assorted finish. Return unit depth: 50 cm.



Glass tops
Structural melamine top matching the metal leg finish. Wood veneer sliding doors (+ col.)
W. 175 x D. 300 cm

From stock
3 160 053 + top + leg + col.



On request
3 160 053 + top + leg + JU



Top structurel et portes coulissantes ébénisterie (+ col.)
W. 175 x D. 300 cm

3 160 050 + top + leg + col.



3 160 050 + top + leg + JU



Wood veneer tops
Structural melamine top matching the supporting return and metal leg finish. Sliding doors assorted to worktop finish.
W. 175 x D. 300 cm

From stock
3 160 047 + top + leg



On request
3 160 047 JU + leg



Structural wood veneer top and sliding doors assorted to worktop finish.
W. 175 x D. 300 cm

3 160 044 + top + leg



3 160 044 JU + leg



■ Rectangular desks with supporting return

Melamine desk return shell in a high gloss black RO or aluminium grey MH finish, matching the metal leg finish. Metal handles in assorted finish. Return unit depth: 50 cm.



Glass tops
Structural melamine top matching the metal leg finish. Wood veneer sliding doors (+ col.)
W. 215 x D. 200 cm
W. 235 x D. 200 cm

From stock
3 160 051 + top + leg + col.
3 160 052 + top + leg + col.



On request
3 160 051 + top + leg + JU
3 160 052 + top + leg + JU



Structural wood veneer top and sliding doors (+ col.)
W. 215 x D. 200 cm
W. 235 x D. 200 cm

3 160 048 + top + leg + col.
3 160 049 + top + leg + col.



3 160 048 + top + leg + JU
3 160 049 + top + leg + JU



Wood veneer tops
Structural melamine top matching the supporting return and metal leg finish. Sliding doors assorted to worktop finish.
W. 215 x D. 200 cm
W. 235 x D. 200 cm

From stock
3 160 045 + top + leg
3 160 046 + top + leg



On request
3 160 045 JU + leg
3 160 046 JU + leg



Structural wood veneer top and sliding doors assorted to worktop finish.
W. 215 x D. 200 cm
W. 235 x D. 200 cm

3 160 042 + top + leg
3 160 043 + top + leg



3 160 042 JU + leg
3 160 043 JU + leg



4 choices of finish for worktops (+ top) and sliding doors (+ col.)



From stock

On request

4 choices of finish for glass worktops (+ top)



From stock

* 4 leg desks only

2 choices of finish for shell and supporting return



From stock

2 choices of finish for metal leg (+ leg)



From stock

■ Rectangular desks with fixed return

Fixed return unit depth: 60 cm.



Wood veneer tops

W. 180 x D. 200 x 60 cm
W. 200 x D. 200 x 60 cm

From stock

3 160 054 + top + leg
3 160 055 + top + leg



On request

3 160 054 JU + leg
3 160 055 JU + leg



■ Optional metal modesty panel



Compatible with Frame leg desks only
For desks W. 180 cm
For desks W. 200 cm

3 160 056 + leg
3 160 057 + leg



Meeting tables

■ Circular tables



Glass tops

Ø 120 cm on central stem

Enamelled

3 160 062 + top + leg



Transparent

3 160 062 + top + leg



Wood veneer tops

Ø 120 cm on central stem

From stock

3 160 058 + top + leg
3 160 059 + top + fin.



On request

3 160 058 JU + leg
3 160 059 JU + leg



■ Square tables



Glass tops

W. 150 x D. 150 cm on centred Frame base

Enamelled

3 160 063 + top + leg



Wood veneer tops

W. 150 x D. 150 cm on centred Frame base
W. 150 x D. 150 cm on 4 legs

From stock

3 160 060 + top + leg
3 160 061 + top + leg



On request

3 160 060 JU + leg
3 160 061 JU + leg



Easy reach storage units

■ Mobile metal pedestal, drawer fronts with wood veneer inlay

Metal handles assorted to pedestal finish



H. 58.8 x W. 42 x D. 56 cm

From stock

1 box drawer + 1 filing drawer
3 box drawers

3 160 064 + top + leg
3 160 065 + top + leg



On request

3 160 064 JU + leg
3 160 065 JU + leg



Optional wood veneer top for pedestals

3 160 066 + top



3 160 066 JU



■ Low credenzas with 2 sliding doors



Melamine shell and structural top in a high gloss black RO or aluminium grey MH finish (+ fin.). Metal handles in assorted finish. Resting on 6 metal feet matching the credenza shell finish. Wood veneer sliding doors.

H. 66.7 x W. 200 x D. 50 cm

3 160 068 + top + fin.



3 160 068 + JU + fin.



Melamine shell in a high gloss black RO or aluminium grey MH finish (+ fin.). Metal handles in assorted finish. Resting on 6 metal feet matching the credenza shell finish. Wood veneer top and sliding doors.

H. 66.7 x W. 200 x D. 50 cm

3 160 067 + top + fin.















3 160 067 + JU + fin.







Deco storage solutions

Melamine cupboard shell in a high gloss black RO or aluminium grey MH finish (+ fin.). Wood veneer doors (+ top). Drop leaf compartment door assorted to the melamine structure finish.









	From stock		On request	
 Low cupboard H. 83.5 x W. 100 x D. 46 cm - 1 shelf 2 wood veneer doors	3 160 070 + top + fin.		3 160 070 + JU + fin	
 Medium cupboard H. 115.7 x W. 100 x D. 46 cm - 2 shelves 2 wooden doors, with open compartment in the top section 2 wooden doors, with drop leaf door compartment in the section	3 160 071 + top + fin.		3 160 071 + JU + fin	
	3 160 072 + top + fin.		3 160 072 + JU + fin	
 High cupboard H. 191.7 x W. 100 x D. 46 cm - 4 shelves 4 doors, with open compartment in the central section 4 doors, with drop leaf door compartment in the central section	3 160 073 + top + fin.		3 160 073 + JU + fin	
	3 160 074 + top + fin.		3 160 074 + JU + fin	

Optional extras for Deco cupboards

	From stock		On request	
 Optional wood veneer top for cupboards W. 100 cm	3 140 009 + top		3 140 009 JU	
 Additional melamine shelf	3 140 043 + RO or MH			

Traditional storage solutions

Melamine cupboard shell and shelves 19 mm thick. 2 choices of finish : MH aluminium grey or MY graphite grey (+ fin.). Handles in an aluminium grey finish. Toughened safety glass doors 4 mm thick with aluminium frame.

	Enamelled		Transparent	
 Low cupboard H. 71 x W. 80 x D. 42.6 cm 2 glass doors	3 160 075 + top + fin.		3 160 075 + top + fin.	
 Medium cupboard H. 133.3 x W. 80 x D. 42.6 cm 2 glass doors	3 160 076 + top + fin.		3 160 076 + top + fin.	
 High cupboard H. 197.3 x W. 80 x D. 42.6 cm 4 glass doors	3 160 077 + top + fin.		3 160 077 + top + fin.	

Optional extras for traditional storage units

Optional melamine shelf in an aluminium grey or graphite grey finish. For cupboards W. 80 cm	3 160 078 + fin.	
Optional decorative top for traditional storage units - contact us for details		

4 choices of finish for worktops (+ top) and sliding doors (+ col.)

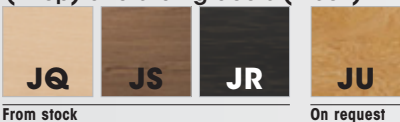

4 choices of finish for glass worktops (+ top)



2 choices of finish for shell and supporting return

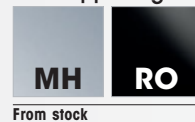

2 choices of finish for metal leg (+ leg)



Inveo

Inveo, a distinctive fusion of modern lines and original design.

The range stands out for its use of high quality elements such as wood veneer worktops, and its combination of matt and glossy materials to produce a fresh contemporary look.

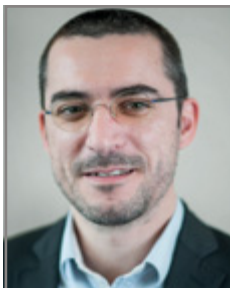

"Inveo draws inspiration from classic Executive Furniture designs. I am particularly fond of its curved lines and combination of quality traditional and cutting-edge materials."

XAVIER DEVAUX Data and Project Marketing Manager



Making a **statement**



Bringing together
curved worktops
with delicate
elliptical leg
designs





INVEO allows you to create **an entirely personalised workspace**, thanks to its 3 distinctive worktop designs and extensive range of matching complementary storage solutions.

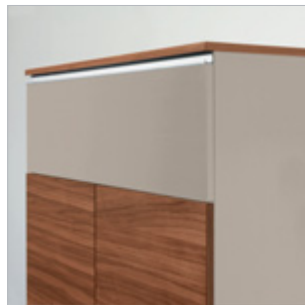
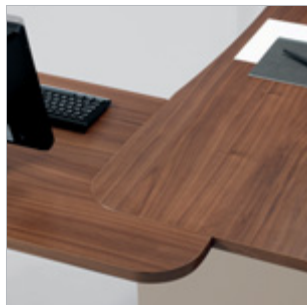







Shade card

2 choices of finish for wood veneer tops

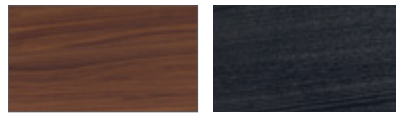

JN

Semi-matt
walnut

JA

Black ash

2 choices of finish for methacrylate panel legs (arch-shaped desks)

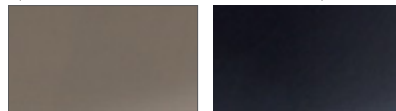

LF

Gloss
cappuccino

LG

Gloss black

2 choices of finish for melamine panel legs (curved desks)

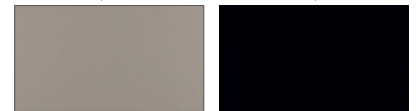

NY

Taupe

NX

Black

2 choices of finish for elliptical legs



SA

Aluminium
grey

QN

Black

Wood veneer panelling is a natural material. It may therefore present variations in colour and pattern particularly when viewed at different angles to the grain and at different angles to the light.

The Range

Desking and extension units

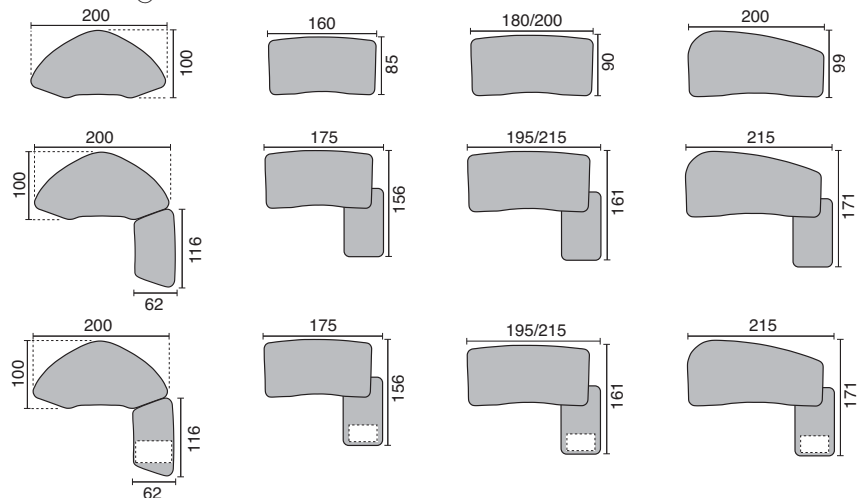

Meeting tables

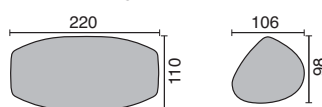

Standards



Technical specifications

Desks - height 73.5 cm

1 Wood veneer worktops, 29 mm thick, with rounded edges. Wood veneer edge banding, 2 mm thick and assorted to the tops. Choice of 3 shapes: arched, pebble shaped and curved.

2 Elliptical design tubular steel legs 10/10 mm thick. Legs fitted with adjustable stabilizer feet, adjust through 15 mm.

3 Panel legs particular to the arch-shaped desks. Curved design MDF panel legs with rounded edges, 20 mm thick. High gloss methacrylate finish. Legs fitted with adjustable stabilizer feet, adjust through 15 mm.

4 Panel legs particular to curved-design desks. Melamine leg panel, cut in arch shape on the visitor side, hardwood veneer panelling. Legs fitted with adjustable stabilizer feet, adjust through 15 mm. 4 possible combinations.

5 Optional wood veneer modesty panel matching the worktops, height 29 cm and 29 mm thick. Secured to the worktops by means of cam-fittings attached to the curved or pebble shaped desks.

6 Mobile pedestals or returns match with melamine or glossy methacrylate leg finishes. Tops and drawer fronts in a wood veneer finish matching the worktops. Pedestals with metal drawers fitted on ball-bearing runners, open to depth of 90%. Selective drawer opening. Pen tray. Central locking mechanism.

7 Meeting tables with elliptical design metal legs. Teardrop shaped worktop, seats 3 to 4 people. Or cylindrical shape worktop, seats 8 to 10 people.

8 Two types of storage solutions in matching finish:

- Deco storage units composed of cupboards with melamine or glossy methacrylate finish shell. Tops and side panels in wood veneer, with grain direction aligned horizontally. No handles, doors open thanks to 'push & pull' mechanism. Medium and high cupboards fitted with choice of pigeonhole compartment or glossy methacrylate fold-down work surface.

- Traditional storage units composed of melamine cupboards with 19 mm thick shell and shelves. Doors in wood veneer finish matching the worktops. Toughened glass doors 4 mm thick with aluminium frame. Metal handles. 3 point lock on high cupboard. 1 point lock on medium and low cupboards. Glass doors are not lockable. Stabilizer feet H. 28 mm, adjust through 15 mm. Optional tops and side panels in wood veneer finish matching the doors.

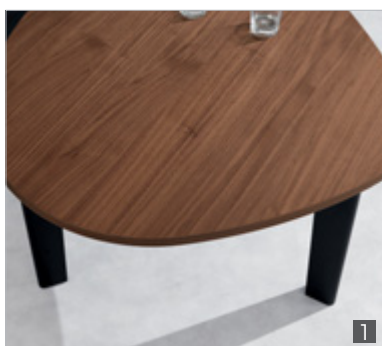

■ Arch-shaped desks with central panel leg



Arch-shaped desks

W. 200 x D. 100 cm

3 071 068 + top + leg1 + leg



Arch-shaped desks with fixed return on panel leg

Return can be positioned either on left or right side of the desk

W. 200 x D. 200 cm

3 071 127 + top + leg1 + leg



Arch-shaped desks with fixed return on elliptical design legs

Return can be positioned either on left or right side of the desk

W. 200 x D. 200 cm

3 071 126 + top + leg1 + leg



Arch-shaped desks with fixed return on supporting pedestal

Return can be positioned either on left or right side of the desk. Pedestal shell in methacrylate finish.

W. 200 x D. 200 cm - 2 drawer pedestal

3 071 163 + top + leg1 + leg

W. 200 x D. 200 cm - 3 drawer pedestal

3 071 164 + top + leg1 + leg



■ Pebble-shaped desk with elliptical design legs



Pebble-shaped desk

W. 200 x D. 99 cm

3 071 195 + top + leg



Pebble-shaped desk with fixed return on elliptical design legs

Return is positioned on right side of the desk

W. 215 x D. 171 cm

3 071 201 + top + leg



Pebble-shaped desk with fixed return on supporting pedestal

Return is positioned on right side of the desk.

Pedestal shell in methacrylate LF or LG finish (+col.) or melamine finish NX or NY (+ col.)

Methacrylate shell - 2 drawers

W. 215 x D. 171 cm

3 071 202 + top + col. + leg



Methacrylate shell - 3 drawers

W. 215 x D. 171 cm

3 071 203 + top + col. + leg



Melamine shell - 2 drawers

W. 215 x D. 171 cm

3 071 202 + top + col. + leg



Melamine shell - 3 drawers

W. 215 x D. 171 cm

3 071 203 + top + col. + leg



■ Curved desks on elliptical design legs



Curved desks

W. 200 x D. 90 cm

3 071 035 + top + leg

W. 180 x D. 90 cm

3 071 034 + top + leg

W. 160 x D. 85 cm

3 071 033 + top + leg



Curved desks with fixed return on elliptical design legs

Left-hand return

W. 215 x D. 161 cm 3 071 050 + top + leg

W. 195 x D. 161 cm 3 071 049 + top + leg

W. 175 x D. 156 cm 3 071 048 + top + leg



Right-hand return

3 071 047 + top + leg

3 071 046 + top + leg

3 071 045 + top + leg



Curved desks with fixed return on supporting pedestal

Pedestal shell in methacrylate LF or LG finish (+ col.) or melamine finish NX or NY (+ col.)



Left-hand return
 Methacrylate shell – 2 drawers
 W. 215 x D. 161 cm 3 071 080 + top + col. + leg
 W. 195 x D. 161 cm 3 071 079 + top + col. + leg
 W. 175 x D. 156 cm 3 071 078 + top + col. + leg

Right-hand return
 3 071 074 + top + col. + leg
 3 071 073 + top + col. + leg
 3 071 072 + top + col. + leg



Methacrylate shell – 3 drawers
 W. 215 x D. 161 cm 3 071 083 + top + col. + leg
 W. 195 x D. 161 cm 3 071 082 + top + col. + leg
 W. 175 x D. 156 cm 3 071 081 + top + col. + leg

3 071 077 + top + col. + leg
 3 071 076 + top + col. + leg
 3 071 075 + top + col. + leg

Melamine shell – 2 drawers
 W. 215 x D. 161 cm 3 071 080 + top + col. + leg
 W. 195 x D. 161 cm 3 071 079 + top + col. + leg
 W. 175 x D. 156 cm 3 071 078 + top + col. + leg

3 071 074 + top + col. + leg
 3 071 073 + top + col. + leg
 3 071 072 + top + col. + leg

Melamine shell – 3 drawers
 W. 215 x D. 161 cm 3 071 083 + top + col. + leg
 W. 195 x D. 161 cm 3 071 082 + top + col. + leg
 W. 175 x D. 156 cm 3 071 081 + top + col. + leg

3 071 077 + top + col. + leg
 3 071 076 + top + col. + leg
 3 071 075 + top + col. + leg

■ **Curved desks with panel legs**



Curved desks
 W. 200 x D. 90 cm
 W. 180 x D. 90 cm
 W. 160 x D. 85 cm

3 071 194 + top + leg 2
 3 071 193 + top + leg 2
 3 071 192 + top + leg 2



Curved desks with fixed return on panel leg

Left-hand return
 W. 215 x D. 161 cm 3 071 206 + top + leg 2
 W. 195 x D. 161 cm 3 071 207 + top + leg 2
 W. 175 x D. 156 cm 3 071 208 + top + leg 2

Right-hand return
 3 071 209 + top + leg 2
 3 071 210 + top + leg 2
 3 071 211 + top + leg 2



Curved desks with fixed return on supporting pedestal

Pedestal shell in wood veneer finish matching the worktop, pedestal handle in SA or QN finish (+ col.)

Left-hand return
 2 drawers
 W. 215 x D. 161 cm 3 071 212 + top + leg 2 + col.
 W. 195 x D. 161 cm 3 071 214 + top + leg 2 + col.
 W. 175 x D. 156 cm 3 071 215 + top + leg 2 + col.

Right-hand return
 3 071 213 + top + leg 2 + col.
 3 071 216 + top + leg 2 + col.
 3 071 217 + top + leg 2 + col.

3 drawers
 W. 215 x D. 161 cm 3 071 218 + top + leg 2 + col.
 W. 195 x D. 161 cm 3 071 219 + top + leg 2 + col.
 W. 175 x D. 156 cm 3 071 220 + top + leg 2 + col.

3 071 221 + top + leg 2 + col.
 3 071 222 + top + leg 2 + col.
 3 071 223 + top + leg 2 + col.

■ **Optional wood veneer modesty panels**

For curved desks W.200 or 215 cm
 For curved desks W.180 or 195 cm or pebble shape
 For curved desks W.160 or 175 cm

3 071 170 + top + leg
 3 071 169 + top + leg
 3 071 168 + top + leg

2 choices of finish for wood veneer tops (+ top)



2 choices of finish for methacrylate panel legs (arch-shaped desks) (+ leg1)

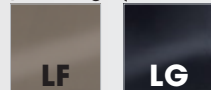

2 choices of finish for melamine panel legs (curved desks) (+ leg2)



2 choices of finish for elliptical design legs (+ leg)



■ Meeting tables



Teardrop shape table - seats 3 to 4 people

Supported by 3 elliptical design legs.

W. 106 x D. 98 cm

3 071 058 + top + leg



Cylindrical shape table - seats 8 to 10 people

Supported by 4 elliptical design legs.

W. 220 x D. 110 cm

3 071 057 + top + leg



■ Easy reach storage solutions

Wood veneer finish (+top). Methacrylate pedestal shell LF or LG (+ col.) or melamine NX or NY (+ col.). Pedestal handles SA or QN (+ fin.1).

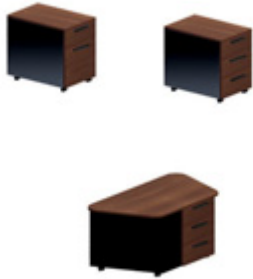

Mobile pedestals W. 40 x D. 60 x H. 55.20 cm

Methacrylate shell - 2 drawers

3 071 069 + top + col. + fin. 1

Methacrylate shell - 3drawers

3 071 070 + top + col. + fin. 1

Melamine shell - 2 drawers

3 071 069 + top + col. + fin. 1

Melamine shell - 3drawers

3 071 070 + top + col. + fin. 1



Mobile returns - 3 drawers W. 118 x D. 64 x H. 56 cm

Methacrylate shell

3 071 071 + top + col. + fin. 1

Melamine shell

3 071 071 + top + col. + fin. 1



■ Deco storage solutions

Cupboard shell in melamine NX or NY - or methacrylate LF or LG (+ fin). Fold-down work surface in melamine NX or NY (+ col.) or methacrylate LF or LG (+ col.)



Cupboards H. 83.5 x W. 100 x D. 46 cm - 2 wood doors - 1 shelf

2 wood doors

Melamine shell

3 071 153 + top. + fin.

Methacrylate shell

3 071 153 + top. + fin.



Cupboards H. 115.7 x W. 100 x D. 46 cm - 2 wood doors - 2 shelves

Open top compartment

Melamine shell

3 071 226 + top. + fin.

Methacrylate shell

3 071 226 + top. + fin.

Fold-down work surface

Melamine shell

3 071 155 + top. + fin. + col.

Methacrylate shell

3 071 155 + top. + fin. + col.



Cupboards H. 191.7 x W. 100 x D. 46 cm - 4 wood doors - 4 shelves

Open central compartment

Melamine shell

3 071 227 + top. + fin.

Methacrylate shell

3 071 227 + top. + fin.

Fold-down work surface

Melamine shell

3 071 154 + top. + fin. + col.

Methacrylate shell

3 071 154 + top. + fin. + col.



Optional extras for deco storage solutions

Additional melamine shelf

3 071 172 + fin.

Additional methacrylate shelf

3 071 172 + fin.



■ Traditional storage solutions



Low cupboards H. 71 x W. 80 x D. 40.7 (without doors) or D. 42.6 cm – 1 shelf

Without doors	3 071 162 + fin.
2 plain doors	3 071 131 + top + fin.
2 enamelled glass doors	3 071 133 + glass + fin.
Refrigerator unit	3 071 159 + top + fin.

Medium cupboards H. 133.3 x W. 80 x D. 40.7 (without doors) or D. 42.6 cm – 3 shelves

Without doors	3 071 160 + fin.
2 plain doors	3 071 130 + top + fin.
2 enamelled glass doors	3 071 132 + glass + fin.
2 plain doors + 1/2 bookcase	3 071 136 + top + fin.

High cupboards H. 197.3 x W. 80 x D. 40.7 (without doors) or D. 42.6 cm – 4 shelves

Without doors	3 071 161 + fin.
2 plain doors	3 071 199 + top
4 plain doors	3 071 134 + top
4 enamelled glass doors	3 071 135 + glass + fin.
1/3 plain doors + 2/3 enamelled glass doors	3 071 147 + top + fin. + glass
1/3 plain doors + 2/3 bookcase	3 071 137 + top + fin.
Wardrobe	3 071 229 + top + fin.

■ Optional extras for traditional storage solutions

Decorative top 20 mm thick matching the doors D. 43.2 cm

W. 80 cm	3 071 178 + top
W. 160 cm	3 071 176 + top



Set of 2 decorative side panels 20 mm thick – Require fitting of decorative top

For cupboard H. 71 cm	3 071 188 + top
For cupboard H. 133.3 cm	3 071 186 + top
For cupboard H. 197.3 cm	3 071 187 + top

Optional melamine shelf

For cupboard W. 80 cm	3 071 171 + fin.
-----------------------	------------------



Graphite grey metal shelf for suspension files

For cupboard W. 80 cm	3 071 190 SC
-----------------------	--------------



Telescopic metal cradle for suspension files

For cupboard W. 80 cm	3 071 228 SG
-----------------------	--------------



2 choices of finish for wood veneer tops and doors (+ top)



2 choices of finish for elliptical design legs from stock (+ leg)

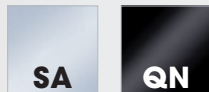

2 choices of finish for glossy enamelled glass doors (+ glass)



2 choices of finish for melamine cupboard shells (+fin)



Kara

Kara is a versatile range of executive furniture that combines a linear design with up to date finishes. Its effective and stylish design combines expansive work surfaces with practical storage solutions adapted to the needs of today's executives.



"I wanted to find a desk that projected a sober yet contemporary image. With its long clean lines, high quality finish and elegant supporting return, Kara is everything I was looking for."

PASCAL MOREAU Special projects estimator



Decision-making



Clean lines and expertly conceived finishing touches





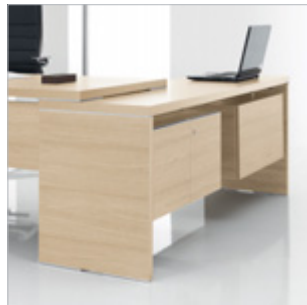



Shade card

3 melamine worktop and leg finishes



MN
White oak



RL
Amber walnut



ML
Brown oak

1 glass worktop finish



GK*
Gloss white enamelled

The Range

Rectangular office desks

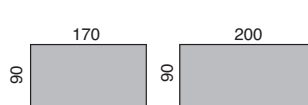

Rectangular office desks with structural pedestal

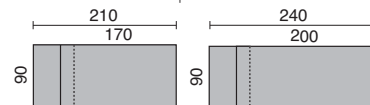

Rectangular office desks with return

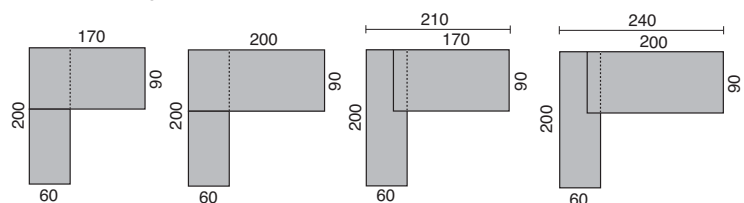

Rectangular office desks with return and pedestal

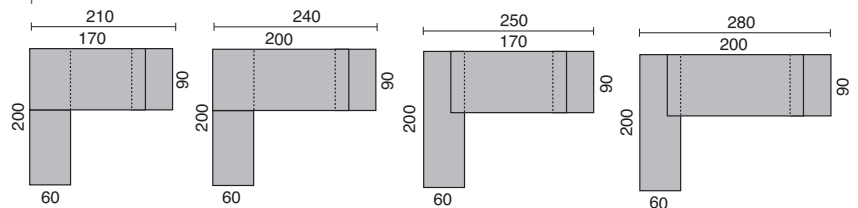

Rectangular office desks with return * *

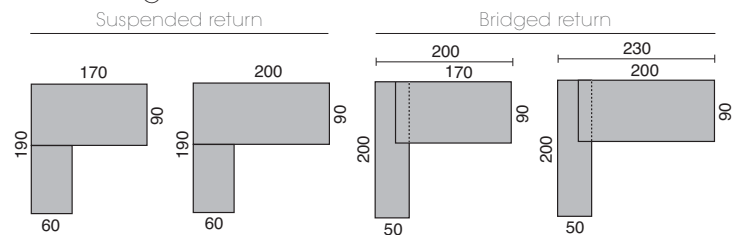

Meeting

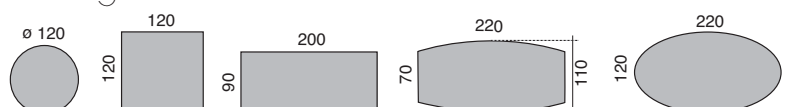

*Return and pedestals only - ** on request

Standards



1 2



3 4



5



5

Technical specifications

Desks – height 74 cm

1 Melamine balanced high-density fibreboard panel, 38 mm thick. 2 mm thick strip of ABS (in matching finish) fitted to desktop outline and rounded on the top and bottom edges.

2 Melamine panel legs 38 mm thick, fitted with metal crossbars W.200 x 38 mm, affording the unit an elegant and functional finish.

3 Fixed structural metal crossbar in an aluminium grey finish.

4 Optional matching melamine modesty panel, height 30 cm.

5 Supporting return resting on melamine leg fitted with 2 metallic finish PVC strips. Toughened enamelled glass worktop 6mm thick, or melamine worktop 38 mm thick. Cable ports integrated in the return panel facilitate cable management.

6 Large 3 drawer pedestal unit protrudes beyond the end of the desktop, offering additional work surface. Drawers open with «push & latch» mechanism. Enamelled glass top 6mm thick, or melamine top 38 mm thick. Features a drawer incorporating a pen tray: W. 60 x D. 90 x H. 69 cm

7 Rectangular or square meeting table, supported by 4 metal legs with melamine finish on the external surfaces that match the worktops.

8 Deco bookcase, melamine structure 38 mm thick. Features 12 melamine shelves 19 mm thick. Central section with back panel. Brilliant white enamelled glass sliding doors. Profiled aluminium guide rails. Metal handles in an aluminium finish.

9 Melamine cupboards - carcass and shelves 19 mm thick, aluminium grey finish. Doors and tops in melamine finish matching the worktops. Toughened glass doors 6 mm thick. Metal handles in an aluminium finish. 3 point lock on high cupboard. 1 point on medium and low cupboards. No lock on glass doors. Stabilizer feet H. 28 mm, adjust through 15 mm.



6



7



8

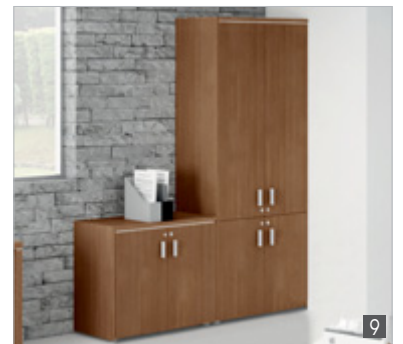

9

■ Rectangular office desks

Structural pedestal and supporting return can be positioned on left or right.

Without modesty panel

With modesty panel



W. 170 x D. 90 cm 3 636 064 + top + top

W. 200 x D. 90 cm 3 636 066 + top + top

3 636 113 + top + top

3 636 115 + top + top

With 3 drawer structural pedestal



W. 210 x D. 90 cm 3 636 065 + top + top

W. 240 x D. 90 cm 3 636 067 + top + top

3 636 114 + top + top

3 636 116 + top + top

■ Rectangular office desks with return

With aligned melamine top return



W. 170 x D. 200 cm 3 636 060 + top + top

W. 200 x D. 200 cm 3 636 062 + top + top

3 636 101 + top + top

3 636 108 + top + top

With aligned glass top return



W. 170 x D. 200 cm 3 636 060 + top + GK

W. 200 x D. 200 cm 3 636 062 + top + GK

3 636 101 + top + GK

3 636 108 + top + GK

With non-aligned melamine top return



W. 210 x D. 200 cm 3 636 056 + top + top

W. 240 x D. 200 cm 3 636 058 + top + top

3 636 096 + top + top

3 636 099 + top + top

With non-aligned glass top return



W. 210 x D. 200 cm 3 636 056 + top + GK

W. 240 x D. 200 cm 3 636 058 + top + GK

3 636 096 + top + GK

3 636 099 + top + GK

■ Rectangular office desks with return and structural pedestal

With 3 drawer structural pedestal and aligned melamine top return



W. 210 x D. 200 cm 3 636 061 + top + top

W. 240 x D. 200 cm 3 636 063 + top + top

3 636 094 + top + top

3 636 098 + top + top

With melamine top 3 drawer structural pedestal and aligned glass top return



W. 210 x D. 200 cm 3 636 061 + top + GK

W. 240 x D. 200 cm 3 636 063 + top + GK

3 636 094 + top + GK

3 636 098 + top + GK

With glass top 3 drawer structural pedestal and aligned return



W. 210 x D. 200 cm 3 636 102 + top + GK

W. 240 x D. 200 cm 3 636 106 + top + GK

3 636 111 + top + GK

3 636 112 + top + GK

■ Rectangular office desks with return and structural pedestal

Structural pedestal and supporting return can be positioned on left or right.

Without modesty panel

With modesty panel

With 3 drawer structural pedestal and non-aligned melamine top return



W. 250 x D. 200 cm 3 636 057 + top + top
W. 280 x D. 200 cm 3 636 059 + top + top



3 636 097 + top + top
3 636 100 + top + top



With melamine top 3 drawer structural pedestal and non-aligned glass top return



W. 250 x D. 200 cm 3 636 057 + top + GK
W. 280 x D. 200 cm 3 636 059 + top + GK



3 636 097 + top + GK
3 636 100 + top + GK



With glass top 3 drawer structural pedestal and non-aligned return



W. 250 x D. 200 cm 3 636 109 + top + GK
W. 280 x D. 200 cm 3 636 110 + top + GK



3 636 103 + top + GK
3 636 105 + top + GK



■ Rectangular office desks with suspended or bridge return

ON REQUEST (allow 6 weeks). For quantities of 5 desks or more, contacts us for order details.

Desk with suspended return to be positioned on left or right



W. 170 x D. 90 cm 3 636 117 + top + top
W. 200 x D. 90 cm 3 636 118 + top + top



Desk with bridge return to be positioned on left or right, without integrated storage solutions



W. 200 x D. 200 cm 3 636 119 + top + top
W. 230 x D. 200 cm 3 636 120 + top + top



Desk with bridge return to be positioned on left or right, with integrated storage solutions and CPU desk mount



W. 200 x D. 200 cm 3 636 121 + top + top
W. 230 x D. 200 cm 3 636 122 + top + top



■ Free-standing extension unit

ON REQUEST (allow 6 weeks). For quantities of 5 desks or more, contacts us for order details.

Extension unit without integrated storage solutions



W. 200 x D. 50 cm 3 636 123 + top + top



Extension unit with integrated storage solutions and CPU desk mount



W. 200 x D. 50 cm 3 636 124 + top + top



3 melamine worktop and leg finishes (+ top)

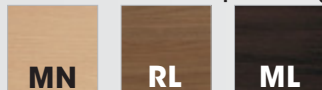

1 glass worktop finish



*return and pedestals only

■ Easy-reach storage solutions

Mobile melamine pedestals

Built-in pen tray. Selective drawer opening mechanism, open to a depth of 75%. Central locking. Metal handles in aluminium grey.



W. 40 x D. 60 x H. 55.40 cm

2 drawers, 1 for SF

3 636 091 + top + SB

3 drawers

3 636 092 + top + SB



■ Meeting desks

Square or rectangular desks with 4 square section tubular metal legs 60 x 60 mm in an aluminium grey finish or 2 external surfaces in wood-effect finish. Round and barrel desks supported by 1 or 2 central stems in an aluminium grey finish.



Square section metal legs

4 leg tables

W. 120 x D. 120 cm 3 636 140 + top + SA

W. 200 x D. 90 cm 3 636 148 + top + SA

Round table

Ø 120 cm

Barrel table with 2 central stems

W. 220 x D. 110 cm

Square section wood-effect legs

3 636 165 + top + SA

3 636 166 + top + SA

1 central stem

3 636 163 + top + SA

2 central stems

3 636 164 + top + SA



■ Guest low tables

Melamine table tops and legs, 38 mm thick. > Height 40 cm.

2 finishes on request (allow 5 weeks): white oak MN and brown oak ML

W. 70 x D. 70 cm

6 720 029 + top

W. 110 x D. 70 cm

6 720 030 + top



■ Deco bookcase

Melamine structure 38 mm thick. Melamine shelves 19 mm thick. Brilliant white enamelled glass sliding doors or standard melamine door. Profiled aluminium guide rails. Metal handles in an aluminium finish.

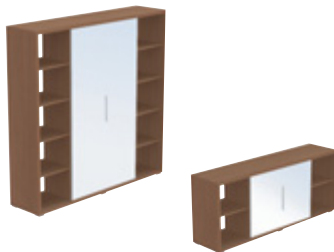

Melamine doors

W. 200 x H 200 cm 3 636 167 + top. + SB

W. 200 x H. 83.6 cm 3 636 168 + top. + SB

Glass doors

3 636 150 + top + GK

3 636 093 + top + GK



■ Traditional storage solutions

Low cupboards H. 71 x W. 80 x D. 40.7 (without doors) or D. 42.6 cm - 1 shelf

Without doors

3 636 084 MH

2 full-panel doors

3 636 077 + top + MH

2 enamelled glass doors

3 636 070 GK MH

2 frosted glass doors

3 636 070 GA MH

Refrigerator unit

3 636 169 + top + MH





Medium cupboards H. 133.3 x W. 80 x D. 40.7 (without doors) or D. 42.6 cm – 3 shelves

Without doors	3 636 085 MH
2 full-panel doors	3 636 078 + top + MH
2 enamelled glass doors	3 636 071 GK MH
2 frosted glass doors	3 636 071 GA MH
1/2 full-panel door + 1/2 bookcase	3 636 073 + top + MH



High cupboards H. 197.3 x W. 80 x D. 40.7 (without doors) or D. 42.6 cm – 4 shelves

Without doors	3 636 086 MH
2 full-panel doors	3 636 079 + top + MH
4 full-panel doors	3 636 072 + top + MH
1/3 full-panel doors + 2/3 enamelled glass doors	3 636 076 + top + MH GK
1/3 full-panel doors + 2/3 frosted glass doors	3 636 076 + top + MH GA
4 full-panel doors + central bookcase	3 636 075 + top + MH
1/3 full-panel doors + 2/3 central bookcase	3 636 074 + top + MH
Wardrobe	3 636 162 + top + MH

■ Options for traditional storage solutions

Decorative melamine top 19 mm thick, matching the doors D. 43.20 cm

W. 80 cm	3 636 131 + top
W. 160 cm	3 636 132 + top



Set of 2 decorative side panels 19 mm thick. Require fitting of decorative melamine top (on request - allow 6 weeks)

For cupboard H. 71 cm	3 636 137 + top
For cupboard H. 133.3 cm	3 636 138 + top
For cupboard H. 197.3 cm	3 636 139 + top

Optional melamine shelf

For cupboard W. 80 cm	3 636 134 MH
-----------------------	--------------



Optional metal shelf for suspension files, in graphite grey finish.

For cupboard W. 80 cm	3 636 135 SC
-----------------------	--------------



Telescopic metal filing cradles for suspension files, in black finish.

For cupboard W. 80 cm	3 636 136 SG
-----------------------	--------------



3 choices of worktop, leg and melamine door finish (+top)

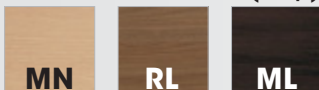

2 choices of glass door colour



1 finish for melamine cupboard shell



M38

M38 is a range of contemporary and cutting-edge design executive furniture. With an extensive pallet of colours and choice of elegant materials on offer, M38 has something to suit any contemporary management executive's tastes.

The range successfully incorporates a wide variety of shapes, colours and materials in the design of solid worktops, pedestals and other units.



"Freedom is action, movement, choice. M38 is the answer. The variety of the design, the diversity of shapes offers a wide aesthetical palette. Each has its own style."

NATHALIE MALLET Editing Manager



Efficient day-to-day **management**



**With purity
and subtle
refinement,**
glass brings light
to its surroundings.





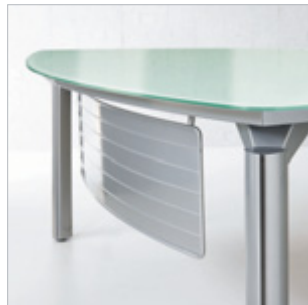

Ergonomic and
sleek curved
edges



Shade card

3 choices of finish for melamine worktops and square-section metal leg embellishers



MN
White oak

RL
Amber walnut

ML
Brown oak

2 choices of glass worktop finish



GB
Glossy light grey enamelled

GD
Glossy black enamelled

2 choices of metal leg finish



SA
Aluminium grey

LW
Black gloss

The Range

Desking

Melamine worktops

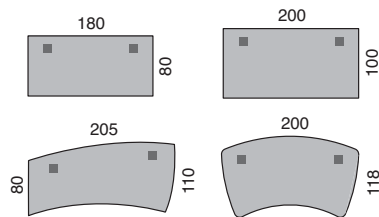

Glass worktops

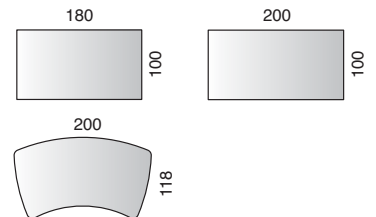

Extension units

Melamine worktops

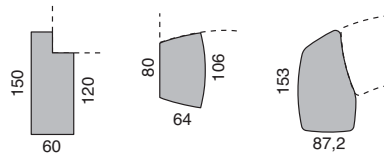

Glass worktops

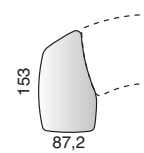

Meeting tables

Melamine worktops

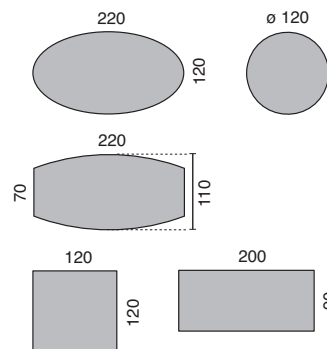

Glass worktops

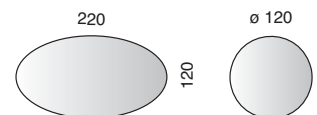

Standards



1

Guarantee
5
years

Manufactured to
ISO
9001

Manufactured to
ISO
14001

except glass tops

Made in the E.U.

in our facilities

except glass tops

Made in the E.U.

glass tops

glass tops

finishes
ML and MN

finish RL

Technical specifications

Desks - height 74.8 cm.

1 Tops made from counterweighted, high-density particle board, 38 mm thick. Features 2 square ABS cable ports in an aluminium grey finish, facilitating cable management (main work surfaces only). Strip of ABS 2 mm thick (in matching finish) fitted to desktop edges..

2 Toughened enamelled glass worktop 12 mm thick, for rectangular shaped tops. Smooth and polished joints, rounded on the top and bottom edges. Attaches to the desk structure with suction pads.

3 Frame-shaped legs made of triangular cross-section tubular steel 59 x 59 x 80 mm. Structural support provided by tubular beam attached to the legs. Stabilizer feet adjust through 15 mm.

4 Tubular metal legs of square section 60 x 60 mm, 2 mm thick. Inside surfaces of the leg are covered in a metallic envelope, and 2 outside surfaces with melamine wood-effect embellishers. Legs attach to the structure with screws and inserts. Stabilizer feet adjust through 15 mm.

5 Rounded triangular metal legs, \varnothing 70 mm. Triangular metal top plate. Stabilizer feet (adjustable through 25 mm). Melamine tops rest on 4 structural legs. Glass tops rest on a metal frame, secured by suction pads and supported by 4 structural legs.

6 Metal modesty panel is curved so as to embrace the shape of the worktop. Tubular section frame with decorative groove H. 27 cm or optional rectangular metal modesty panel H. 27 cm with decorative grooves, for melamine or rectangular glass desks.

7 Metal mobile pedestal with decorative melamine front panelling and recessed metal handles matching the pedestal shell. Melamine wood-effect back matching the front panelling. Selective opening metal drawers fitted to telescopic runners and ball-bearing rollers. Top drawer opens fully. Folding key. Built-in ABS pen tray.

8 Deco bookcase, melamine structure 38 mm thick. Features 12 melamine shelves 19 mm thick. Central section with back panel. Choice of brilliant white enamelled glass or melamine sliding doors. Profilled aluminium guide rails. Metal handles in an aluminium finish.

9 Melamine cupboards - shell and shelves 19 mm thick, in grey aluminium or graphite grey finish. Optional tops and side panels in melamine finish matching the doors. Toughened glass doors 6 mm thick. Metal handles in an aluminium finish. 3 point lock on high cupboard. 1 point lock on medium and low cupboards. Glass doors are not lockable. Stabilizer feet H. 28 mm, adjust through 15 mm.



2



3



4



5

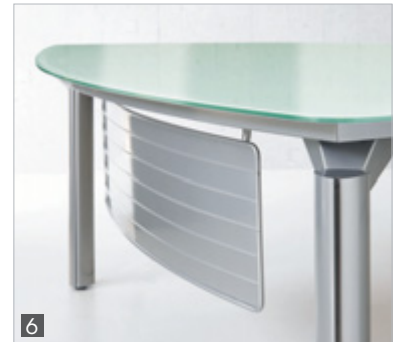

6



7



8



9

Square-section metal legs/ melamine embellishers

Structure with melamine worktop

■ Rectangular desks

W. 180 x D. 80 cm	3 095 692 + top + leg	
W. 200 x D. 100 cm	3 095 693 + top + leg	

■ Fixed returns for rectangular desks

On square-section leg

W. 150 x D. 60 cm - left-hand return	3 095 694 + top + leg	
W. 150 x D. 60 cm - right-hand return	3 095 695 + top + leg	

On structural metal pedestal with inlayed melamine panelling

W. 150 x D. 60 cm - left-hand return	3 095 239 + top + leg	
W. 150 x D. 60 cm - right-hand return	3 095 234 + top + leg	

■ Asymmetrical wave desks

W. 205 x D. 110 cm - left-hand return	3 095 698 + top + leg	
W. 205 x D. 110 cm - right-hand return	3 095 699 + top + leg	

■ Fixed returns for asymmetrical wave desks

On square-section leg

W. 106 x D. 64/80 cm	3 095 700 + top + leg	
----------------------	-----------------------	--

On structural metal pedestal with inlayed melamine panelling

W. 106 x D. 64/80 cm	3 095 223 + top + leg	
----------------------	-----------------------	---

■ Optional modesty panels

For rectangular desks W. 180 cm	3 095 670 + leg	
For rectangular desks W. 200 cm	3 095 671 + leg	

Frame-shaped legs

■ Rectangular desks

Melamine worktop

W. 180 x D. 80 cm	3 095 203 + top + leg	
W. 200 x D. 100 cm	3 095 207 + top + leg	

Glass worktop

W. 180 x D. 100 cm	3 095 690 + top + leg	
W. 200 x D. 100 cm	3 095 691 + top + leg	

■ Fixed returns for rectangular desks

Structure with melamine worktop

On 'frame' leg

W. 150 x D. 60 cm - left-hand return	3 095 240 + top + leg	
W. 150 x D. 60 cm - right-hand return	3 095 235 + top + leg	

On supporting metal pedestal with inlayed melamine panelling

W. 150 x D. 60 cm - left-hand return	3 095 239 + top + leg	
W. 150 x D. 60 cm - right-hand return	3 095 234 + top + leg	

3 choices of finish for melamine worktops (+ top)

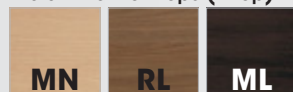

2 choices of finish for glass worktops (+ top)



2 choices of finish for metal legs (+ leg)

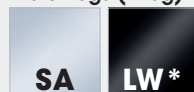

*Except rounded triangular legs

■ Asymmetrical wave desks



Structure with melamine worktop

W. 205 x D. 110 cm - left-hand return

3 095 192 + top + leg

W. 205 x D. 110 cm - right-hand return

3 095 189 + top + leg



■ Fixed returns for asymmetrical wave desks



Structure with melamine worktop

On 'frame' leg

W. 106 x D. 64/80 cm

3 095 224 + top + leg

On structural metal pedestal with inlayed melamine panelling

W. 106 x D. 64/80 cm

3 095 223 + top + leg



■ Optional metal modesty panel

For rectangular desks W. 180 cm

3 095 670 + leg

For rectangular desks W. 200 cm

3 095 671 + leg



Rounded triangular legs

Melamine tops for rectangular, wave and extension units

■ Rectangular desks

W. 180 x D. 80 cm

3 095 206 + top + SA

W. 200 x D. 100 cm

3 095 210 + top + SA



■ Fixed returns for rectangular desks

Rectangular office desks

W. 150 x D. 60 cm - left-hand return

3 095 243 + top + SA

W. 150 x D. 60 cm - right-hand return

3 095 238 + top + SA

On structural metal pedestal with inlayed melamine panelling

W. 150 x D. 60 cm - left-hand return

3 095 239 + top + SA

W. 150 x D. 60 cm - right-hand return

3 095 234 + top + SA



■ Asymmetrical wave office desks

W. 205 x D. 110 cm - left-hand return

3 095 198 + top + SA

W. 205 x D. 110 cm - right-hand return

3 095 197 + top + SA



■ Fixed returns for asymmetrical wave desks

On 'frame' leg

W. 106 x D. 64/80 cm

3 095 227 + top + SA

On structural metal pedestal with inlayed melamine panelling

W. 106 x D. 64/80 cm

3 095 223 + top + SA



■ Curved desk

Melamine top

W. 200 x D. 118 cm

3 095 220 + top + SA

Glass top

W. 200 x D. 118 cm

3 095 220 + top + SA



■ Fixed returns for curved desk



Melamine top

On rounded triangular legs

W. 153 x D. 87 cm - left-hand return

3 095 233 + top + SA

W. 153 x D. 87 cm - right-hand return

3 095 230 + top + SA

Glass top

On rounded triangular legs

W. 153 x D. 87 cm - left-hand return

3 095 233 + top + SA

W. 153 x D. 87 cm - right-hand return

3 095 230 + top + SA



Melamine top

On structural metal pedestal with inlayed melamine panelling

W. 153 x D. 87 cm - left-hand return

3 095 231 + top + SA

W. 153 x D. 87 cm - right-hand return

3 095 228 + top + SA



■ Optional metal modesty panel

For rectangular desks W. 180 cm

3 095 670 + leg

For rectangular desks W. 200 cm

3 095 671 + leg

For curved desks

3 095 668 + SA

Meeting tables

■ Oval W. 220 x D. 120 cm – seats 8 people



Melamine top

4 rounded triangular legs

3 095 131 + top + SA

4 square-section metal legs/ melamine embellishers

3 095 702 + top + leg

2 central stems

3 095 721 + top + leg

Glass top

4 rounded triangular legs

3 095 131 + top + SA

■ Circular ø 120 cm – seats 4 people



Melamine top

4 rounded triangular legs

3 095 137 + top + SA

4 square-section metal legs/ melamine embellishers

3 095 703 + top + leg

1 central stem

3 095 723 + top + leg

Glass top

1 central stem

3 095 723 + top + leg

■ Barrel W. 220 x D. 110 cm - seats 6/8 people



Melamine top

4 rounded triangular legs

3 095 134 + top + SA

4 square-section metal legs/ melamine embellishers

3 095 704 + top + leg

2 central stems

3 095 722 + top + leg

■ Square W. 120 x D. 120 cm - seats 4 people



Melamine top

4 rounded triangular legs

3 095 705 + top + SA

4 square-section metal legs/ melamine embellishers

3 095 706 + top + leg

4 square-section metal legs, grey aluminium finish

3 095 707 + top + SA

■ Rectangular W. 200 x D. 90 cm - seats 6/8 people



Melamine top

4 square-section metal legs/ melamine embellishers

3 095 708 + top + leg

4 square-section metal legs, grey aluminium finish

3 095 728 + top + SA

Easy reach storage solutions

■ Pedestals



Metal pedestals - decorative melamine front panelling

W. 42 x D. 56 x H. 58.8 cm

1 box drawer + 1 filing drawer
3 box drawers

3 095 726 + top + fin.

3 095 727 + top + fin.



Melamine pedestals - aluminium grey SB recessed handles

W. 43 x D. 57.5 x H. 55.50 cm

1 box drawer + 1 filing drawer
3 box drawers

3 095 681 + top + SB

3 095 682 + top + SB

■ Deco bookcases

W. 200 x D. 46 cm - grey aluminium SB handles

Melamine doors

H. 83.6 cm

3 095 716 + top + SB

H. 200 cm

3 095 717 + top + SB

Glass doors

H. 83.6 cm

3 095 725 + top + GK

H. 200 cm

3 095 724 + top + GK

■ Traditional storage solutions

Low cupboards H. 71 x W. 80 x D. 40.7 (without doors) or D. 42.6 cm - 1 shelf

Without doors

3 095 634 + fin.

2 plain doors

3 095 641 + top + fin.

2 frosted glass doors

3 095 643 + fin. + GA

2 glossy enamelled glass doors

3 095 643 + fin. + col.

Refrigerator unit

3 095 729 + top + fin.

Medium cupboards H. 133.3 x W. 80 x D. 40.7 (without doors) or D. 42.6 cm - 3 shelves

Without doors

3 095 632 + fin.

2 plain doors

3 095 639 + top + fin.

2 frosted glass doors

3 095 642 + fin. + GA

2 glossy enamelled glass doors

3 095 642 + fin. + col.

2 plain doors + 1/2 bookcase

3 095 645 + top + fin.

High cupboards H. 197.3 x W. 80 x D. 40.7 (without doors) or D. 42.6 cm - 4 shelves

Without doors

3 095 633 + fin.

2 plain doors

3 095 640 + top + fin.

4 plain doors

3 095 644 + top + fin.

1/3 plain doors + 2/3 frosted glass doors

3 095 658 + top + fin. + GA

1/3 plain doors + 2/3 enamelled glass doors

3 095 658 + top + fin. + col.

4 plain doors + central bookcase

3 095 647 + top + fin.

1/3 plain doors + 2/3 central bookcase

3 095 646 + top + fin.

Wardrobe

3 095 718 + top + fin.

■ Optional extras for traditional storage solutions

Decorative top 19 mm thick, D. 43.20 cm

W. 80 cm

3 095 709 + top

W. 160 cm

3 095 710 + top

Decorative side panels 19 mm thick. Require fitting of decorative top (on request)

Set of 2 side panels for cupboard H. 71 cm

3 095 711 + top

Set of 2 side panels for cupboard H. 133.3 cm

3 095 712 + top

Set of 2 side panels for cupboard H. 1697.3 cm

3 095 713 + top



3 choices of finish for melamine tops (+ top)

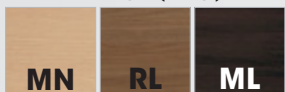

2 choices of finish for glass worktops (+ top)



2 choices of finish for metal legs (+ leg)

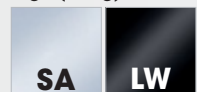

2 choices of finish for melamine cupboard shells (+ fin.)



6 choices of colour for glass doors (+ col.)

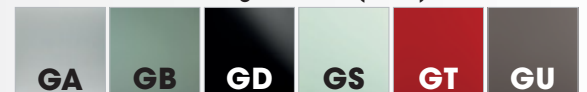

* Except rounded triangular legs

Rio

Rio constitutes a dynamic and functional office furniture range, delicately combining melamine and glass worktops with metal desk structures. With an extensive pallet of available finishes it makes for a modern and inviting workspace.



"I wanted a desk designed with style, conveying a dynamic and colourful image. Rio is the perfect choice as it offers all this and more."

SOPHIE GRAVOT Head of DTP



Straight to the point



Availability of co-ordinating pieces facilitates
a straightforward organisation of your workspace



Shade card

3 choices of finish for melamine worktops



RI
Light
oak



RL
Amber
walnut



MJ
Chocolate
wenge

4 choices of finish for glass tops



GS
White



GU
Mouse grey



GT
Ruby



GJ
Cappuccino

3 choices of finish for structures



SO
White



SA
Aluminium
grey

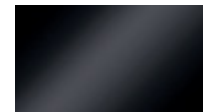

SG
Satin black
grey

The Range

Desking and fixed returns

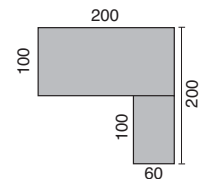
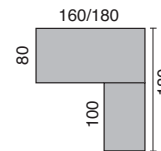

Extension units

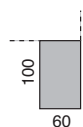

Meeting tables

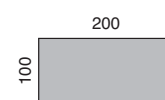
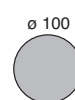

Standards



Technical specifications

Desks – height 73.5 cm

1 Enamelled glass 8 mm thick worktop, spacer mounted with suction pads.

2 Enamelled glass 8 mm thick worktop, embedded in the structure (user and visitor sides) on a metal ruler.

3 Tops made from 25 mm thick counterweighted particle board with a sheet of decorative melamine, edges protected by a strip of 2 mm thick ABS, in a matching finish to the desktop.

4 Arch-shaped legs made of tubular steel 60 x 30 mm, with matching colour ABS foot caps and fitted with stabilizer feet adjustable through 15 mm.

5 Metal modesty attached with metal inserts on the underside of the melamine worktops or secured to a beam extending between the legs of glass top desks.

6 Melamine pedestal with either 2 or 3 drawers fitted to telescopic runners and ball-bearing rollers. Built-in ABS pen tray. Central locking. Folding key. Additional 5th fixed castor for pedestals with filing drawer.

7 Metal pedestal with either 2 or 3 drawers and choice of either melamine or metal top. Optional cushion pad. One piece construction. Drawers on telescopic runners and ball-bearing rollers allow full extraction. Built-in ABS pen tray. Central locking. Folding key.

8 Circular meeting table with square section tubular metal central stem 8 x 8 cm. Melamine or glass worktop.

9 Melamine cupboards - shell and shelves 19 mm thick, in an aluminium grey, graphite grey or white finish. Optional tops and side panels in melamine finish matching the desks. Toughened glass doors 6 mm thick. Metal handles in an aluminium finish. 3 point lock on high cupboard. 1 point lock on medium and low cupboards. Glass doors are not lockable. Stabilizer feet H. 28 mm, adjust through 15 mm.



■ Rectangular desks



Melamine

- W. 166 x D. 80 cm 3 665 207 + top + leg
- W. 186 x D. 80 cm 3 665 192 + top + leg
- W. 206 x D. 100 cm 3 665 208 + top + leg

- W. 166 x D. 80 cm
- W. 186 x D. 80 cm
- W. 206 x D. 100 cm

Glass

Spacer mounted top

- 3 665 193 + top + leg
- 3 665 194 + top + leg
- 3 665 180 + top + leg

Embedded top

- 3 665 195 + top + leg
- 3 665 196 + top + leg
- 3 665 209 + top + leg

■ Rectangular desks with fixed returns



- W. 166 x D. 183 cm 3 665 200 + top + leg
- W. 186 x D. 183 cm 3 665 201 + top + leg
- W. 206 x D. 203 cm 3 665 191 + top + leg

- W. 166 x D. 183 cm
- W. 186 x D. 183 cm
- W. 206 x D. 203 cm

Spacer mounted top

- 3 665 202 + top + leg
- 3 665 203 + top + leg
- 3 665 190 + top + leg

Embedded top

- 3 665 204 + top + leg
- 3 665 205 + top + leg
- 3 665 189 + top + leg

■ Fixed returns

Attaches to left or right side of rectangular desks



- W. 103 x D. 60 cm 3 665 197 + top + leg

Spacer mounted top

- 3 665 198 + top + leg

Embedded top

- 3 665 199 + top + leg

■ Rectangular desks - depth 60 cm



- W. 106 x D. 60 cm 3 665 210 + top + leg

Spacer mounted top

- 3 665 181 + top + leg

Embedded top

- 3 665 182 + top + leg

■ Metal modesty panels

For melamine worktops

- W. 160 cm 3 665 103 + leg
- W. 180 cm 3 665 104 + leg
- W. 200 cm 3 665 105 + leg

For glass worktops

- 3 665 106 + leg
- 3 665 145 + leg
- 3 665 146 + leg

3 choices of finish for melamine worktops (+ top)



4 choices of finish for glass worktops and doors (+ top)



3 choices of finish for structures (+ leg)



3 choices of finish for cupboard shells (+ fin.)



■ Mobile Pedestals

2 drawers

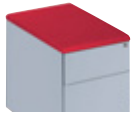

Metal pedestals with metal top

W.41.8 x D.57 x H.56.9 cm 3 665 154 + leg

Metal pedestals with melamine top

W.42 x D.57.2 x H.58.2 cm 3 665 156 + top + leg

Melamine pedestals with aluminium grey handles

W.43.6 x D.56 x H.60 cm 3 665 116 + top

For metal pedestals

Fabric cushion pad

The fabric cushion pad is fitted to the pedestal. For melamine pedestals it is secured to the top with Velcro, and for metal pedestals it is secured with magnetic strips.

3 665 118 + fab. B

3 drawers

3 665 155 + leg

3 665 157 + top + leg

3 665 117 + top

For melamine pedestals

3 665 119 + fab. B

■ Meeting tables



Circular table Melamine

Ø 100 cm 3 665 211 + top + leg

Rectangular table

W. 206 x D. 100 cm 3 665 208 + top + leg

W. 206 x D. 100 cm

Glass

3 665 206 + top + leg

Spacer mounted top

3 665 180 + top + leg

Embedded top

3 665 209 + top + leg

■ Traditional storage solutions

Low cupboards H. 71 x W. 80 x D. 40.7 (without doors) or D. 42.6 cm - 1 shelf

Melamine

Without doors 3 665 150 + fin.

2 doors 3 665 035 + top + fin.

Glass

3 665 043 + top + fin.

Medium cupboards H. 133.3 x W. 80 x D. 40.7 (without doors) or D. 42.6 cm - 3 shelves

Without doors 3 665 151 + fin.

2 doors 3 665 034 + top + fin.

1/2 doors + 1/2 bookcase 3 665 037 + top + fin.

3 665 036 + top + fin.

3 665 039 + top + fin.

High cupboards H. 197.3 x W. 80 x D. 40.7 (without doors) or D. 42.6 cm - 4 shelves

Without doors 3 665 152 + fin.

2 doors 3 665 212 + top + fin.

4 doors 3 665 048 + top + fin.

1/3 doors + 2/3 bookcase 3 665 038 + top + fin.

3 665 049 + top + fin.

3 665 033 + top + fin.

■ Optional extras for traditional storage solutions

Melamine tops 25 mm thick - matching the worktops

W. 80 x D. 43.2 cm

3 665 138 + top

Additional melamine shelf 19 mm thick, matching cupboard shell decorative trim

For cupboard W. 80 cm

3 665 139 + fin.

Graphite grey metal shelf for suspension files

For cupboard W. 80 cm

3 665 140 SC

Black metal telescopic cradle

For cupboard W. 80 cm

3 665 141 SG

